

BRILLIANT™

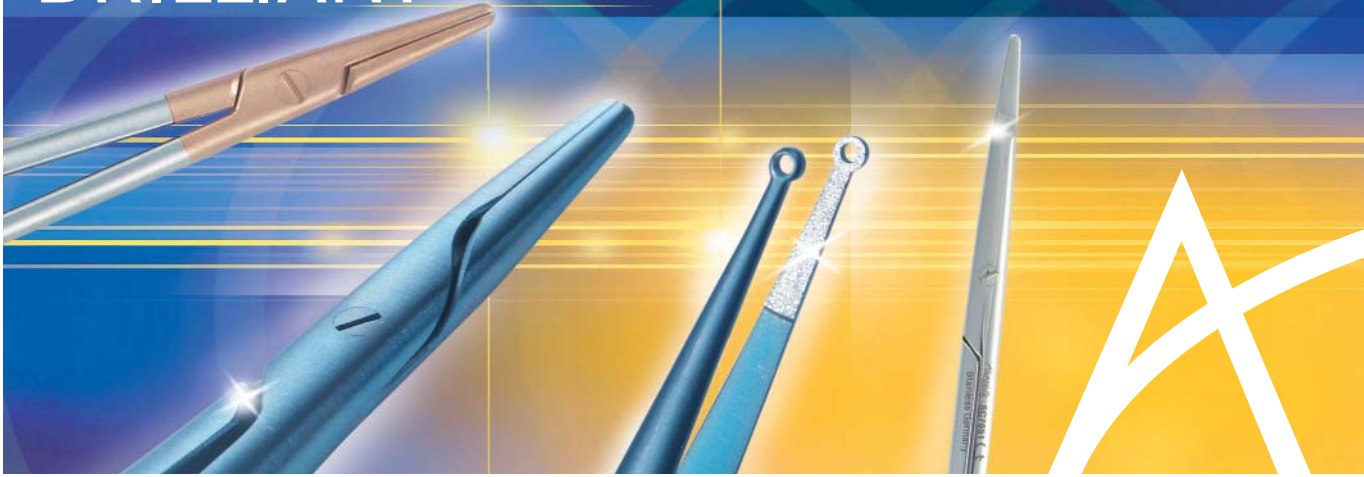

FOR THE  
BEST SURGEONS

**ASANUS**®  
MEDIZINTECHNIK

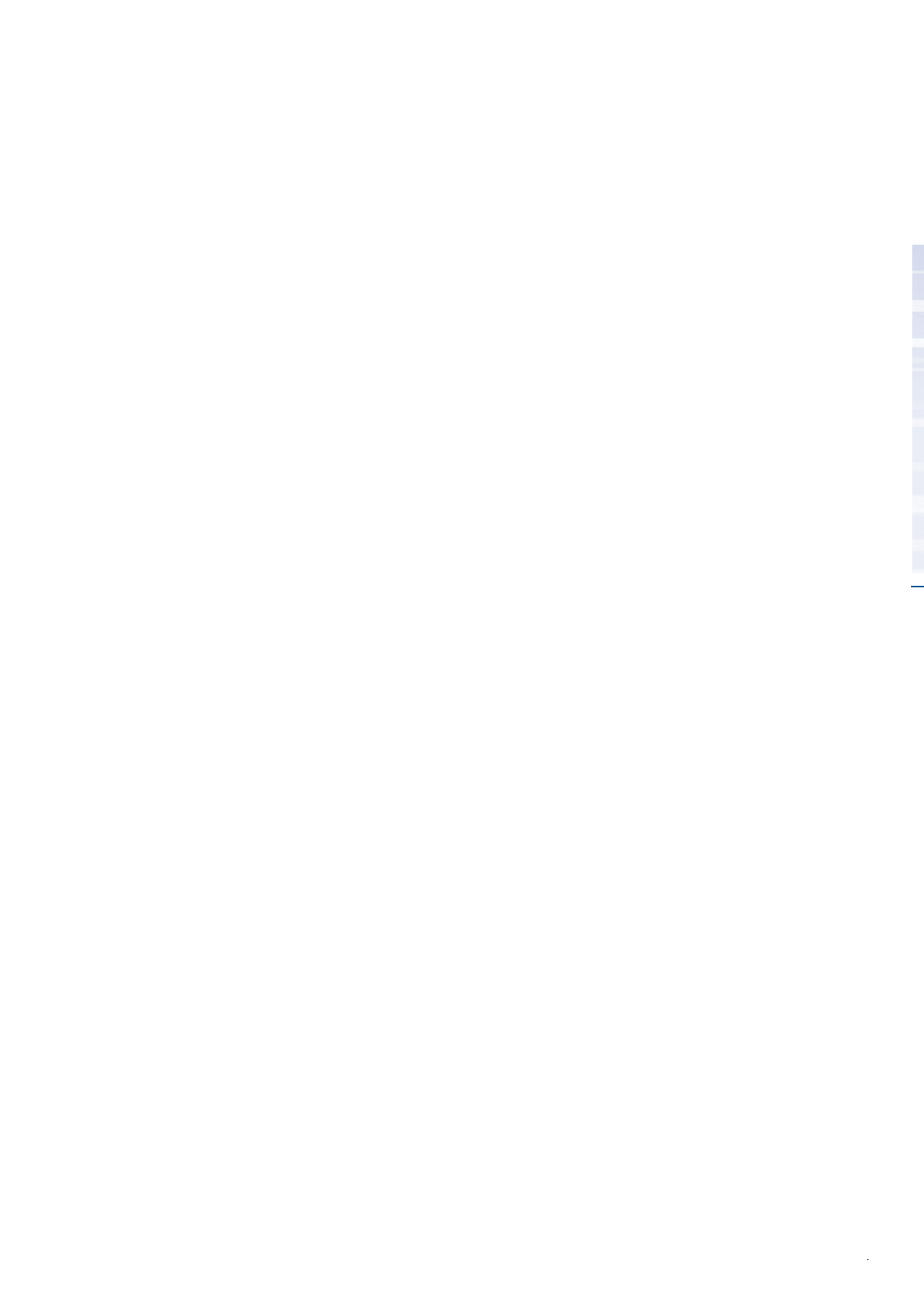



Asanus Medizintechnik GmbH  
take off Gewerbepark 2  
78579 Neuhausen ob Eck  
Germany (Kreis Tuttlingen)

Tel. +49 7467-9474-0  
Fax +49 7467-9474-50  
info@asanus.de  
www.asanus.de

AUSGABE / EDITION 02/2011  
Nachdruck, auch auszugsweise, ist verboten.  
*Reprinting even partially is not allowed.*



ASANUS ist ein leistungsstarker Komplettanbieter von mehr als 18.000 verschiedenen chirurgischen und minimalinvasiven Instrumenten für die Gebiete der Allgemein- und Viszeralchirurgie, Herz-Thorax Chirurgie, Gefäßchirurgie, Urologie, Gynäkologie, Orthopädie, Traumatologie, Mikrochirurgie, Neurochirurgie und Ophthalmologie.

Mit der Entwicklung branchenspezifischer Software für das Sterilgutmanagement, die Logistik und das Qualitätsmanagement verbunden mit der ganzheitlichen Dienstleistung im Prozessmanagement von Sterilgut hat ASANUS sein Leistungsspektrum im operativen Bereich ausgebaut und entsprechend den Marktbedürfnissen angepasst.

#### Entstehung

1998 gründete Armin Schorer die Firma ASANUS mit der Vision ein leistungsstarker Partner in der Medizintechnik für Sie zu werden. Der Begriff ASANUS bedeutet im lateinischen HIN ZUR GESUNDHEIT. Er setzt sich aus den Buchstaben „A“ wie „hinzu“ und dem Wort „SANUS“ wie „Gesundheit“ zusammen.

Der Gedanke in der Medizin Neues zu schaffen und die vielen Ideen von Praktikern aus dem Ärzte- und Pflegebereich schnell in Ihrem Sinne zu verwirklichen hat den Gründer maßgeblich dazu bewegt, ASANUS ins Leben zu rufen.

Mehr als 20 Jahre war Armin Schorer bereits in der Medizintechnik tätig und hatte wertvolle Erfahrungen bei weltweit operierenden, renommierten und namhaften Unternehmen sammeln können. Mit diesem soliden Fundament an Erfahrung und einem hervorragenden Mitarbeiterstamm konnte sich ASANUS von Anfang an einen Platz als Ausrüster chirurgischer Instrumente in der Medizintechnik sichern. Es ist uns ein wichtiges Anliegen, das bereits Geschaffene weiter für Sie und in Ihrem Sinne auszubauen. Mit über 18.000 verschiedenen chirurgischen Instrumenten nahezu für jeden operativen Fachbereich sind wir Komplettanbieter für den operativen Bereich im chirurgischen Instrumentarium. Neben den technischen Produkten bieten wir Ihnen ausgereifte Software für Ihre Logistik und das Qualitätsmanagement im Gesundheitswesen an. Im Einklang von Produkten und unserer Software sind wir in der Lage schnell und präzise für Sie Siebsichtungen, Reorganisationen und wertvolle Wirtschaftsanalysen im Instrumentenmanagement durchzuführen.

Im Einklang zwischen hohem handwerklichem Können und dem Einsatz modernster computergesteuerter Produktionstechnik liefern wir heute Produkte in alle Teile der Welt, die zur Heilung erkrankter Menschen dienen.

Mit diesem Auftrag leisten wir einen wertvollen Beitrag im Gesundheitswesen und freuen uns darauf, auch Ihnen unsere Leistungen zur Verfügung stellen zu können.

*ASANUS is a powerful complete supplier for more than 18,000 different surgical and minimum-invasive instruments for the areas visceral surgery, cardio thoracic surgery, vascular surgery, urology, gynecology, orthopedics, traumatology, microsurgery, neurosurgery and ophthalmology.*

*With the development of sectoral software for sterile products management, the logistics and the quality management linked with the integral service in the process management of sterile goods ASANUS has developed his business activities in the surgical area and has adapted according to the market needs.*

#### History

*In 1998 Armin Schorer founded the company ASANUS with the vision of becoming a highly competitive partner in the medicine technology for you. The word ASANUS means in Latin "THERE TO THE HEALTH". He subjoins himself from the letters "A" for "there to" and the word "SANUS" for "health" together.*

*The thought to create something new in the medicine and to realize many ideas of experts from the doctor's and nursing area fast in their sense has moved the founder decisively to bring ASANUS to life.*

*More than 20 years Armin Schorer was already active in the medicine technology and had been able to collect valuable experiences at worldwide operating, renowned and namable enterprises. With this solid foundation in experience and excellent members of staff ASANUS could fortify itself as a supplier of surgical instruments in the medicine technology from the outset. For us it is an important concern to develop the already created further for you in your sense. With more than 18,000 different surgical instruments nearly for every surgical department we are a complete supplier for the surgical area in the surgical instruments. Besides technical products we offer you an well engineered software for your logistic and quality management in the health service. In the harmony of products and our software we are in the situation and to carry out quick siftings, re-organisations and valuable economic analyses in the instrument management exactly for you.*

*Today in the harmony between high craft skill and the application of the most modern computer-controlled production technology we deliver products in all parts of the world which are used for the healing of ill people.*

*With this order we achieve a valuable contribution in the health care and we are glad to be able to provide you also with our benefits.*

**“Der Mensch steht im Mittelpunkt unserer Leistung”**

In diesem Sinne gehen wir bei ASANUS mit allen Leistungen und der Fertigung unserer Produkte, einschließlich unserem Service, um.

Fachmännische Fertigung in höchstmöglicher Präzision sind die Basis unserer chirurgischer Instrumente.

Chirurgiemechaniker mit sensibler Feinmotorik fertigen in traditioneller Weise unsere chirurgischen Qualitätsinstrumente von ausgewählten Materialien in bester Qualität. Der präzise Gang, die Maulführung, die Weichheit und Elastizität oder auch eine strikte kraftvolle Führung der ASANUS Instrumente wird von handwerklich erfahrenden Fertigungsspezialisten stets im Einklang der Liebe zum Produkt garantiert.

Die ASANUS Instrumente durchlaufen eine weit über den Normen liegende Qualitätskontrolle, wo alle spezifischen Details auf die jeweiligen Instrumententypen abgestimmt, exakt auf die Anforderungen der entsprechenden Qualitätsansprüche professioneller Chirurgen kontrolliert werden.

Die ASANUS Medizinprodukte werden seit der Gründung nach diesen strengen Maßgaben hergestellt.

Dieser Standard wurde bei ASANUS mit der Zertifizierung nach DIN ISO 9001, EN 13485 unter hohen Maßstäben von Anfang an konsequent umgesetzt und unterliegt auch heute ständig einem regelmäßigen Audit.

ASANUS lebt Qualität

**“Man is in center of our performance”**

*This philosophy underlies all our activities at ASANUS, the manufacture of our products and the services we provide for you.*

*Production distinguished by superior craftsmanship and maximum precision is at the heart of our surgical instruments.*

*With acutely-sensitive dexterity and fine motor skills, surgical mechanics employ traditional methods to fashion our quality surgical instruments from select materials of the finest quality. Precision operation and jaw guidance, smoothness and flexibility or absolute, vigorous application of ASANUS instruments are guaranteed by experienced production specialists of an impeccable technical pedigree with a passion for our products.*

*ASANUS instruments are subjected to quality control which far exceeds the expectations of standards. Every specific detail is adapted to suit the particular instrument type and inspected to ensure precise conformity to the requirements and quality expectations of professional surgeons.*

*ASANUS medical products have been manufactured according to these strict specifications since the establishment of the company.*

*Through DIN ISO 9001, EN 13485 certification and the highest of benchmarks, this standard has been consistently implemented right from the start at ASANUS, with regular audits ensuring its maintenance.*

ASANUS - we live quality

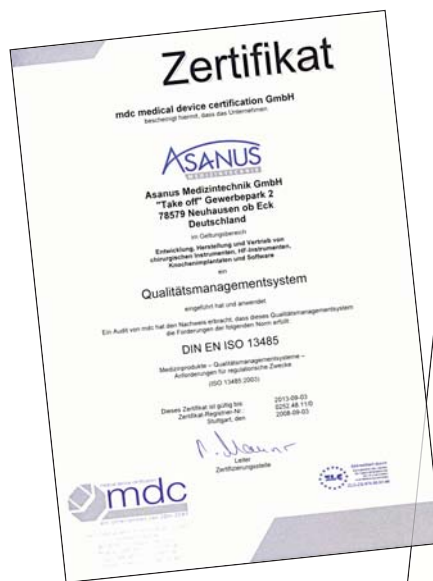
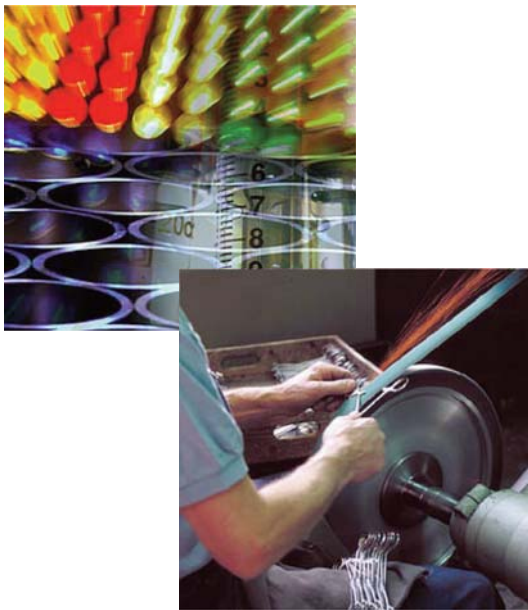

### SEHR LEICHT

- 45% leichter als rostfreie Stahlinstrumente.
- bietet ermüdungsfreies Arbeiten für den Chirurgen für die langen Operationen unter dem Mikroskop
- ist elastisch und weicher als vergüteter Stahl und bietet permanentes hochpräzises Arbeiten für den Chirurgen und verringert somit beim Fassen von Gefäßen deren Traumatisierung.

### LIGHT WEIGHT

- 45 % lighter than stainless steel instruments.
- enables tireless working for the surgeon for long operations under the microscope
- offers permanently high precision to the operating surgeon and may therefore reduce traumatisation of delicate vessels and arteries

### ANTIMAGNETIC

Titan ist antimagnetisches Material. Mit den Blue-Line Titan-nadelhalter können Sie problemlos ohne magnetisierende Einwirkung mit Mikronähnadeln nähen. Ein sicheres und gefühlvolles Arbeiten bietet Ihnen Titan.

### ANTIMAGNETIC

Titanium is an antimagnetic material. It avoids sticking of the needle holder to the stainless suture needles. This allows an optimal, secure and continuous working.

### KEIN ROST – LANGLEBIG

Titan Material und demzufolge Titaninstrumente haben die Eigenschaft, nicht zu rosten.

### NO RUST – LONG LIFE

Titanium- material and instruments does not rust. You will never have problems with rust.

### PFLEGE UND REINIGUNG

Titan Instrumente sind generell sehr pflege- und reinigungs-freundlich. Die Titan Instrumente können in handelsüblichen Reinigungsmittel für herkömmliche Stahlinstrumente gereinigt werden. Nach dem Einsatz sollten die Instrumente gründlich vorgereinigt und gespült werden. Wir empfehlen hierzu speziell für die Mikroinstrumente und Diamantmesser unser Dampfreinigungsgerät Art. Nr. ST 9000. Auf Anfrage bieten wir Ihnen auch Reinigungsmittel für chirurgische Instrumente an. Vor der Sterilisation empfehlen wir kurzes Einölen mit unserem „STERISOFT“ Art.Nr.OL 5000.

### MAINTENANCE/CLEANING

Titanium instruments are principally very easy to clean and maintain. Titanium instruments may be cleaned with usual detergent for surgical instruments. Please rinse the instruments after usage. Herefore we recommend especially for all Micro Instruments and Diamond knives our steam cleaner unit item no. ST 9000. On request we offer you cleaning fluid for the instruments too. Before sterilisation we recommend to oil the surgical instruments with our „STERISOFT“ item no. OL 5000.



## ASANUS TITAN-NADELHALTER MIT MULTI - LOCK SYSTEM MIKRONADELHALTER – EINER FÜR ZWEI

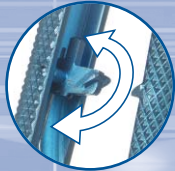

Die ASANUS Multi - Lock Nadelhalter können mit Sperre oder ohne Sperre eingesetzt werden und intraoperativ umgestellt werden, zum Beispiel zum Anreichen von Nahtmaterial und späterem Nähen. Ohne Sperre ist dies eine ideale Lösung für Sie. Dies verhindert Herunterfallen von Nahtmaterial während des Anreichens. Oder wenn ein Operateur ohne Sperre und ein anderer mit Sperre arbeiten will bietet der ASANUS Nadelhalter beides in einem. Keine Sperrenprobleme mehr durch Verstellen der herkömmlichen Sperrfedern!!

## ASANUS TITANIUM NEEDLEHOLDER WITH MULTI - LOCK SYSTEM MICRO NEEDLE HOLDER – ONE FOR TWO

ASANUS Multi - Lock needle holder can be used with lock or without lock. The removable lock allows a surgeon intraoperative changing of the lock system. For example when the nurse handles the suture with the closed lock, the surgeon can remove the lock during operation easily. Or one surgeon likes to work with lock and the other one without lock. ASANUS Multi-Lock System gives you these opportunities. No-lock problems with an easy and secure closing mechanism.

## DIAMOND DUSTED

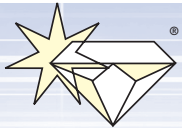

Die qualitativ sehr hochwertige DIAMOND DUSTED Beschichtung besteht aus extrem feinen metallurgischem Partikelgemisch welche eine sehr feine und hochwertige atraumatische Arbeitsoberfläche bietet.

- Zum Beispiel
- für die Pinzetten zum schonenden und atraumatischen Halten von feinstem Gewebe und Gefäßen und Nahtmaterial beim Knüpfen
  - Mit ASANUS-Mikronadelhaltern kann Nahtmaterial bis in die feinsten Größen schonend und griffig genäht werden.

## DIAMOND DUSTED

Finest metallurgically bonded particles create a fine atraumatic surface for extremely atraumatic handling of tissues and suture.

- For example:
- diamond dusted forceps are optimal for fine atraumatic fixation of tissue, micro vessels and fine delicate suture for knitting.
  - diamond dusted ASANUS microneedle holders allow you to use suture up to most delicate suture.

## TITANIT® -INSTRUMENTE

Die ASANUS TITANIT® Instrumente basieren auf einer neuen Fertigungstechnologie mit innovativen und wirtschaftlichen Besonderheiten. Die ASANUS TITANIT® Scheren weisen einen extrem hohen Härtegrad von nahezu 100 HRC auf und zeichnen sich besonders durch eine extrem hohe Schnittqualität aus. Auf diese Schneidequalität gewähren wir 3 Jahre Schnittgarantie bei korrektem Einsatz. Die Erfahrungen und langjährigen klinischen Erprobungen haben gezeigt, dass darüber hinaus die Schnittqualität noch länger anhalten kann. Auch bei Nadelhaltern und Pinzetten kann durch die sehr hohe Härte und vollständig geschlossene Schutzfläche eine wesentlich höhere Abriebfestigkeit erreicht werden.

Dies bringt Ihnen im OP-Einsatz entscheidende Vorteile und eine hohe Wirtschaftlichkeit. Die ASANUS TITANIT® Instrumente sind außerdem korrosions- und säurebeständig, sowie schlagfest. Die ASANUS TITANIT® Instrumente können wie die herkömmlichen chirurgischen Instrumente gemäß RKI-Richtlinien gereinigt, desinfiziert und sterilisiert werden.

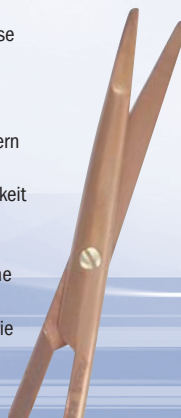

## TITANIT® -INSTRUMENTS

ASANUS TITANIT® surgical instruments are based on a new manufacturing technology with innovative and economical specialties. ASANUS TITANIT® scissors are extremely hard with 100 HRC and grinded with a special high cutting quality. In case of correct handling and use of the ASANUS TITANIT® scissors, ASANUS guarantees a 3 year free service cutting process.

Clinical tests and our experience does show us, that the cutting quality of the ASANUS TITANIT® scissors will remain even longer. The durability of ASANUS TITANIT® needle holders and forceps is also much longer.

These features are of extreme advantage to our customers and provide economical benefits due to very low service costs. ASANUS TITANIT® surgical instruments are extremely acid resistant and impact resistant. Cleaning, disinfection and sterilization of the ASANUS TITANIT® surgical instruments is possible with the normal stainless steel instruments and its previous procedures.



Federsperre  
*Ratched*



Multi Lock  
*Multi Lock*



Gegengewicht  
*Counterbalance*



Streamline  
*Streamline*



Extra Light  
*Extra Light*



Führungsstift  
*Safety Pin*



Diamantiert  
*Diamond Dusted*



Master Light  
*Master Light*



Mikrofeder-Nadelhalter	<i>Micro Needle Holder</i>	NH/NHB	2
Ringnadelhalter	<i>Ring Needle Holder</i>	NH/NHB	13
Nadelhalter POWER TC	<i>Needle Holder POWER TC</i>	NH	14
Mikro-Pinzetten	<i>Micro Forceps</i>	GF/GFB	24
Pinzetten	<i>Forceps</i>	GF/GFB	31
BiTIP Pinzetten	<i>BiTIP Forceps</i>	KG	46
Mikro Scheren	<i>Micro Scissors</i>	SC/SCB	50
Scheren/TITANIT®Scheren	<i>Scissors/Scissors TITANIT</i>	SC/SCB	59
Scheren Standard	<i>Scissors Standard</i>	SC	75
Scheren SUPERCUT	<i>Scissors SUPERCUT</i>	SC	92
Scheren POWER TC	<i>Scissors POWER TC</i>	SC	108
Skalpellgriffe	<i>Scalpell Handle</i>	SK	124
Mikro/Bulldogklemmen	<i>Micro/Bulldog Clamps</i>	GF	125
Wundhaken	<i>Wound Retractors</i>	WH	139
Herz-Thorax-Sperrer	<i>Cardio-Thoracic Retractor</i>	GF	170
Klemmen	<i>Clamps</i>	GL/KF	186
MIS Instrumente	<i>MIS Instrumente</i>	EN	287
Spezielle Instrumente	<i>Special Instruments</i>		294
Aorta Stanzen	<i>Aorta Punches</i>	GF	312
Einmalprodukte	<i>Disposable Products</i>	DSP	313
In Situ Bypass Instrumente	<i>In Situ Bypass Instruments</i>		316
Indexe	<i>Indexe</i>		318

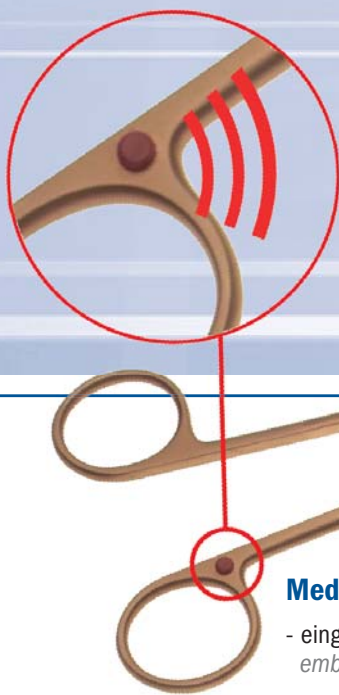

**ARIS**   
Automatic Radio Information System

**MediPlug**

- eingebauter Datenchip  
*embedded data chip*

**Datenchip für jedes Instrument**  
*Data Chip for each Instrument*

- Identifizierung jedes einzelnen Instrumentes vor Ort  
*On-Site Identification of each single instrument*
- Individuelle und spezifische Datenspeicherung und Kontrolle  
*individual and specific data storage and controlling*
- Klinik-resistente, komplett desinfizierbare, schnelle Anbringung  
*clinic resistant, completely disinfectable, fast mounting*
- Produkt- / Herstellerunabhängig  
*Product and producer-independent*

Ab sofort können wir für Sie die ASANUS Instrumente gerne auch mit einer individuellen Serienkennzeichnung, mittels ARIS RFID Chip Technologie versehen.  
Fragen Sie bei uns dies bitte gesondert nach.

*All ASANUS instruments can now be offered with individual serial identification marking, via ARIS RFID chip technology.  
If you are interested, please send us your inquiry.*

NADELHALTER  
NEEDLE HOLDER



mit Multi Lock  
with Multi Lock

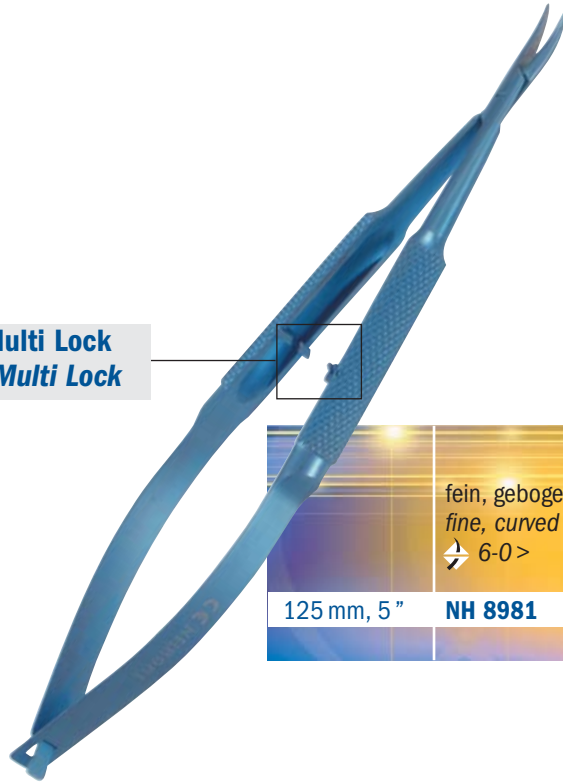

	fein, gebogen fine, curved ↕ 6-0 >		kräftig, gerade strong, straight ↕ 5-0 >	
125 mm, 5"	<b>NH 8981</b>		<b>NH 8030</b>	

mit Multi Lock  
with Multi Lock

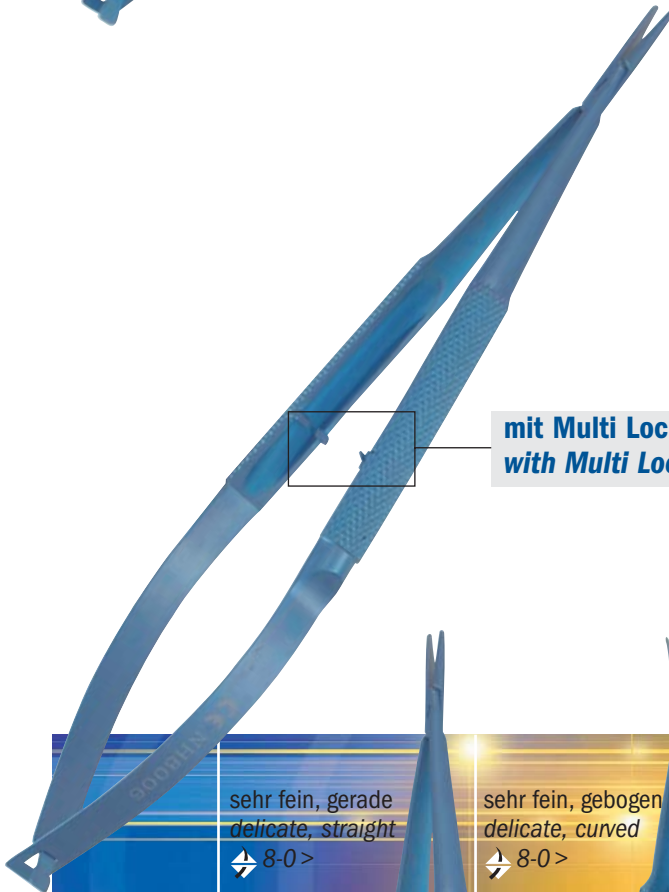

	sehr fein, gerade delicate, straight ↕ 8-0 >	sehr fein, gebogen delicate, curved ↕ 8-0 >	fein, gerade fine, straight ↕ 6-0 >	sehr fein, gebogen delicate, curved ↕ 6-0 >
140 mm, 5 1/2"	<b>NH 8900</b>	<b>NH 8901</b>		
145 mm, 5 3/4"			<b>NH 8006</b>	<b>NH 8005</b>

**EXTRA LIGHT**

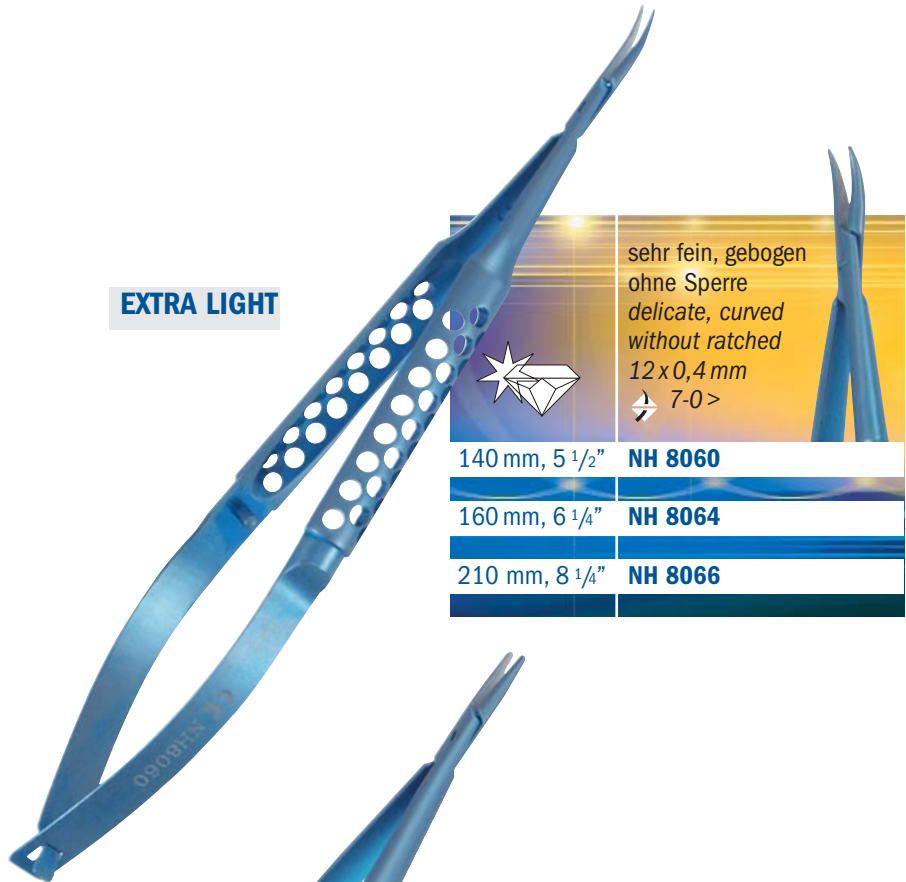

	sehr fein, gebogen ohne Sperre <i>delicate, curved                  without ratched</i> 12 x 0,4 mm ↕ 7-0 >
	140 mm, 5 1/2" <b>NH 8060</b>
	160 mm, 6 1/4" <b>NH 8064</b>
	210 mm, 8 1/4" <b>NH 8066</b>

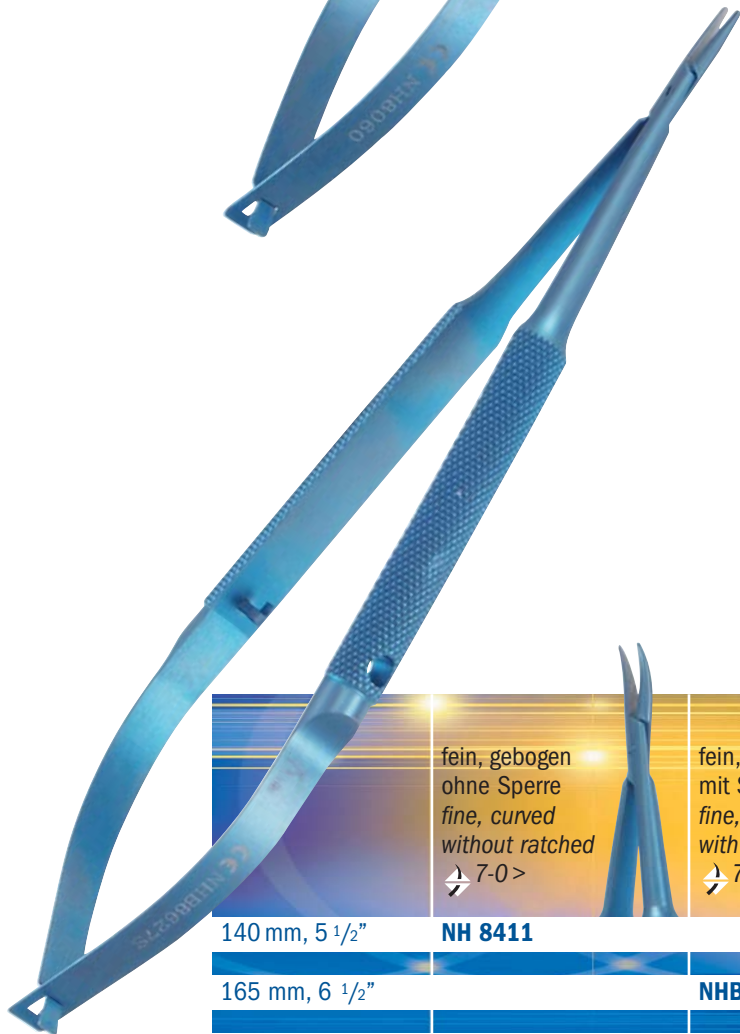

fein, gebogen ohne Sperre <i>fine, curved                  without ratched</i> ↕ 7-0 >	fein, gerade mit Sperre <i>fine, straight                  with ratched</i> ↕ 7-0 >	sehr fein, gerade mit Sperre <i>delicate, s straight                  with ratched</i> ↕ 5-0 >	sehr fein, gebogen mit Sperre <i>delicate, curved                  with ratched</i> ↕ 5-0 >
140 mm, 5 1/2" <b>NH 8411</b>	<b>NHB 8529 S</b>	<b>NHB 8627 S</b>	<b>NHB 8927 S</b>
165 mm, 6 1/2"			

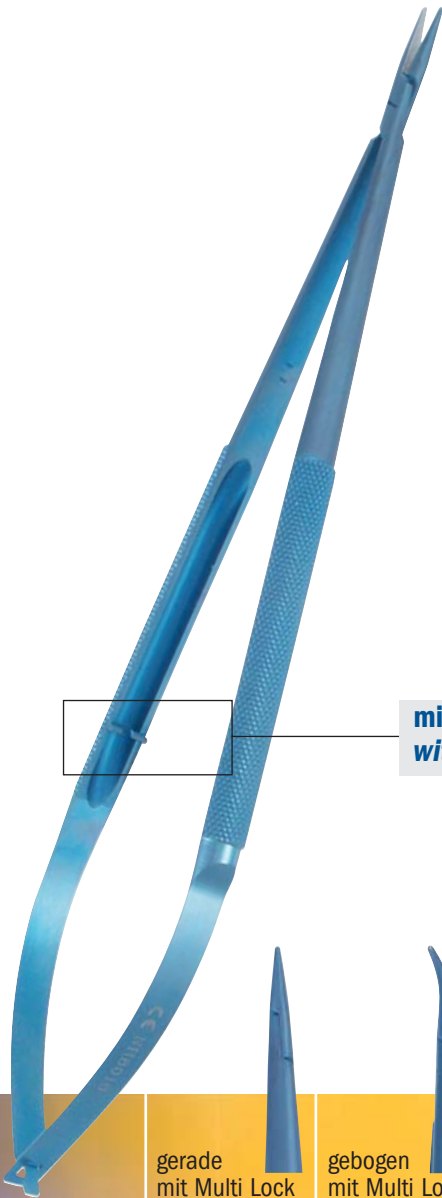

mit Multi Lock  
with Multi Lock

	gerade mit Multi Lock straight with Multi Lock 0,4x11 mm ↕ 7-0>	gerade mit Multi Lock straight with Multi Lock 0,4x10 mm ↕ 8-0>	gerade ohne Sperre straight without ratched 0,4x11 mm ↕ 7-0>	gerade mit Multi Lock straight with Multi Lock 0,4x11 mm ↕ 7-0>
185 mm, 7"			<b>NH 8310</b>	
205 mm, 8"	<b>NH 8016-1</b>	<b>NH 8349</b>	<b>NH 8348</b>	<b>NH 8016-2</b>
230 mm, 9"		<b>NH 8028</b>		

DELICATE

	gerade mit Multi Lock straight with Multi Lock 0,8x11 mm ↕ 6-0>	gebogen mit Multi Lock curved with Multi Lock 0,8x11 mm ↕ 6-0>	gerade mit Multi Lock straight with Multi Lock 1,6x12 mm ↕ 5-0>	gerade mit Multi Lock straight with Multi Lock 2,0x14mm ↕ 3-0>	gerade ohne Sperre straight without Lock 0,8x11 mm ↕ 6-0>	gebogen ohne Sperre curved without Lock 0,8x11 mm ↕ 6-0>	gerade mit Federsperre straight with ratched 0,8x11 mm ↕ 6-0>
160 mm, 6 1/4"	<b>NH 8008</b>	<b>NH 8009</b>					
185 mm, 7 1/4"	<b>NH 8010</b>	<b>NH 8011</b>			<b>NH 8012</b>	<b>NH 8013</b>	<b>NH 8010F</b>
205mm, 8"	<b>NH 8016</b>	<b>NH 8017</b>	<b>NH 8070</b>	<b>NH 8026</b>	<b>NH 8032</b>	<b>NH 8033</b>	<b>NH 8016F</b>
235mm, 9 1/4"	<b>NH 8018</b>	<b>NH 8019</b>	<b>NH 8118</b>				<b>NH 8018F</b>
250 mm, 10"	<b>NH 8020</b>	<b>NH 8021</b>	<b>NH 8022</b>				<b>NH 8020F</b>
300 mm, 12"			<b>NH 8074</b>				

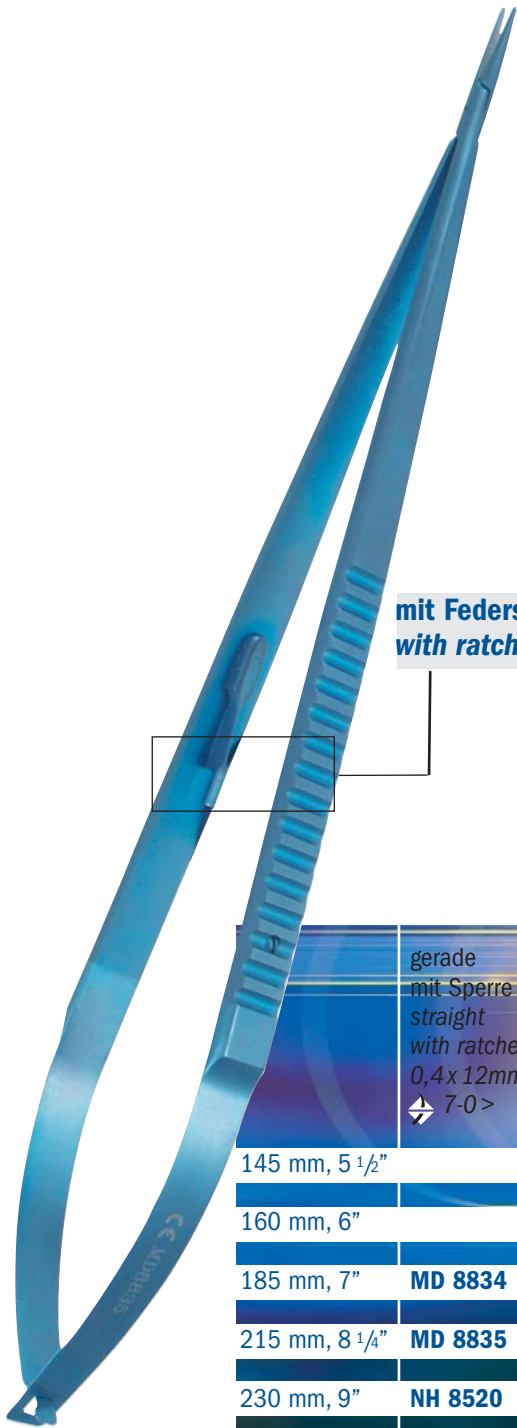

mit Federsperre  
 with ratched

	gerade mit Sperre straight with ratched 0,4 x 12mm ↕ 7-0>	gerade mit Sperre straight with ratched 1,6 x 12mm ↕ 5-0>	gerade ohne Sperre straight without ratched 0,4 x 12mm ↕ 7-0>	gerade ohne Sperre straight without ratched 0,8 x 12mm ↕ 6-0>	gerade mit Sperre straight with ratched ↕ 8x0>	gerade ohne Sperre straight without ratched ↕ 7x0>
145 mm, 5 1/2"					<b>NH 8076</b>	
160 mm, 6"			<b>NH 8079</b>			<b>NH 8078</b>
185 mm, 7"	<b>MD 8834</b>	<b>NH 8070-1</b>		<b>NH 8014</b>		
215 mm, 8 1/4"	<b>MD 8835</b>	<b>NH 8070-2</b>	<b>MD 8835-1</b>	<b>NH 8015</b>		
230 mm, 9"	<b>NH 8520</b>	<b>NH 8070-3</b>				

**FLAT HANDLE**



	gerade mit Multi Lock <i>straight with Multi Lock</i> ↻ 6-0 >	gebogen mit Multi Lock <i>curved with Multi Lock</i> ↻ 6-0 >	gerade ohne Sperre <i>straight without ratched</i> ↻ 6-0 >	gebogen ohne Sperre <i>curved without ratched</i> ↻ 6-0 >
185 mm, 7"	<b>NH 8098</b>	<b>NH 8099</b>		
210 mm, 8 1/4"		<b>NH 8100</b>		<b>NH 8108</b>
250 mm, 10"	<b>NH 8102</b>	<b>NH 8104</b>	<b>NH 8105</b>	
300 mm, 12"	<b>NH 8103</b>			<b>NH 8111</b>

mit Multi Lock  
with Multi Lock

## CROSS ACTON ELEGANCE

für Off-Pump- und in der tiefen  
Chirurgie gewährleistet höheren  
Druck auf die Arbeitsenden

*for off pump and deep surgery  
more compression allows optimal  
needle fixation*

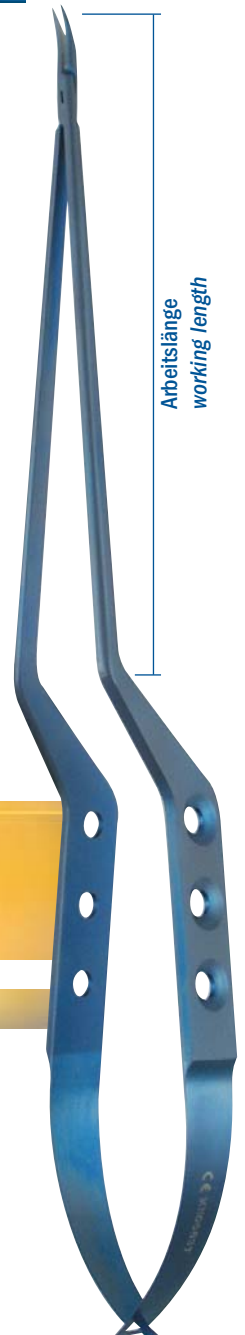



Arbeitslänge  
working length

bajonett gebogen <i>bajonette curved</i> ↻ 6-0 > bis/to 8-0 >	Arbeitslänge working length	
245 mm, 9 1/2"	125 mm, 4 3/4"	<b>MN 0583T</b>

## BAJO



**Schweres Modell  
 Heavy modell**



	gerade mit Sperre straight with ratched ↗ 3-0 >		gebogen mit Sperre curved with ratched ↗ 3-0 >		gerade ohne Sperre straight without ratched ↗ 3-0 >
190 mm, 7 1/2"	<b>NHB 8141S</b>		<b>NHB 8741S</b>		<b>NHB 8141</b>
230 mm, 9"	<b>NHB 8191S</b>				<b>NHB 8191</b>
250 mm, 10"	<b>NHB 8194S</b>				<b>NHB 8194</b>

**TIGER**



mit Federsperre  
 with ratched

mit Stiftsperre  
 with Pin Lock

	gebogen Stiftsperre curved Pin Lock ↗ 6-0 >		gerade Stiftsperre straight Pin Lock ↗ 6-0 >	
215 mm, 8 1/4"	<b>NH 8040</b>		<b>NH 8038</b>	

**PEN**



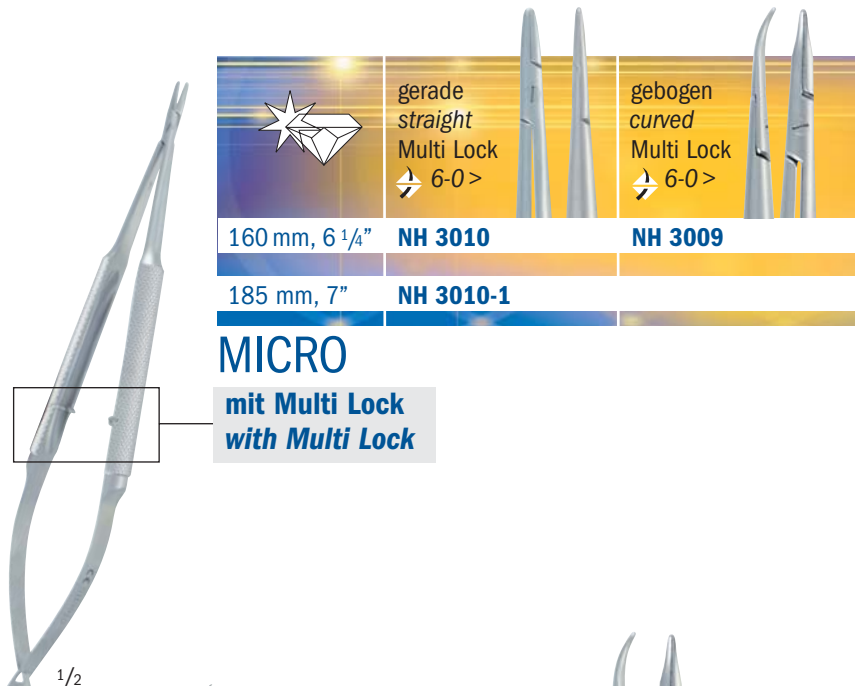



 gerade straight Multi Lock ↗ 6-0 >	gebogen curved Multi Lock ↗ 6-0 >
	160 mm, 6 1/4" <b>NH 3010</b>

**MICRO**  
mit Multi Lock  
with Multi Lock

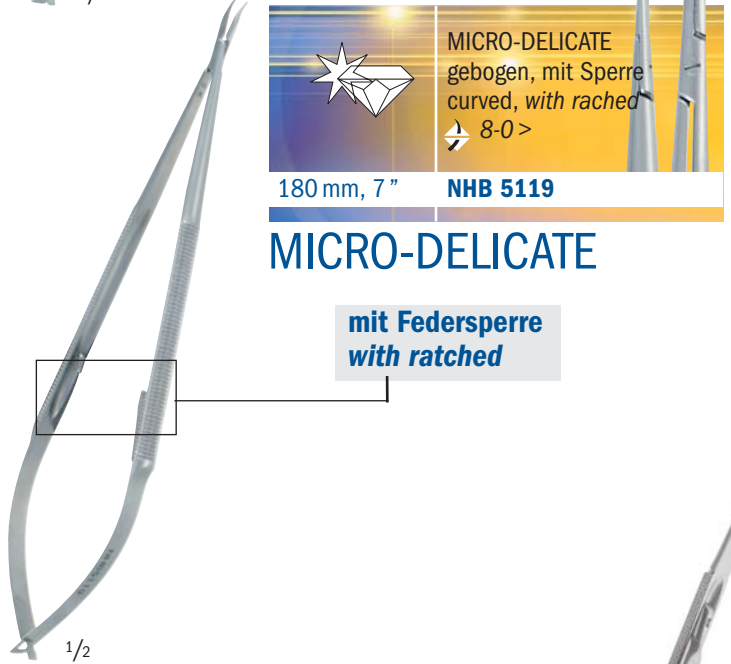
1/2



 MICRO-DELICATE gebogen, mit Sperre curved, with ratched ↗ 8-0 >	180 mm, 7" <b>NHB 5119</b>
--	----------------------------

**MICRO-DELICATE**  
mit Federsperre  
with ratched

1/2

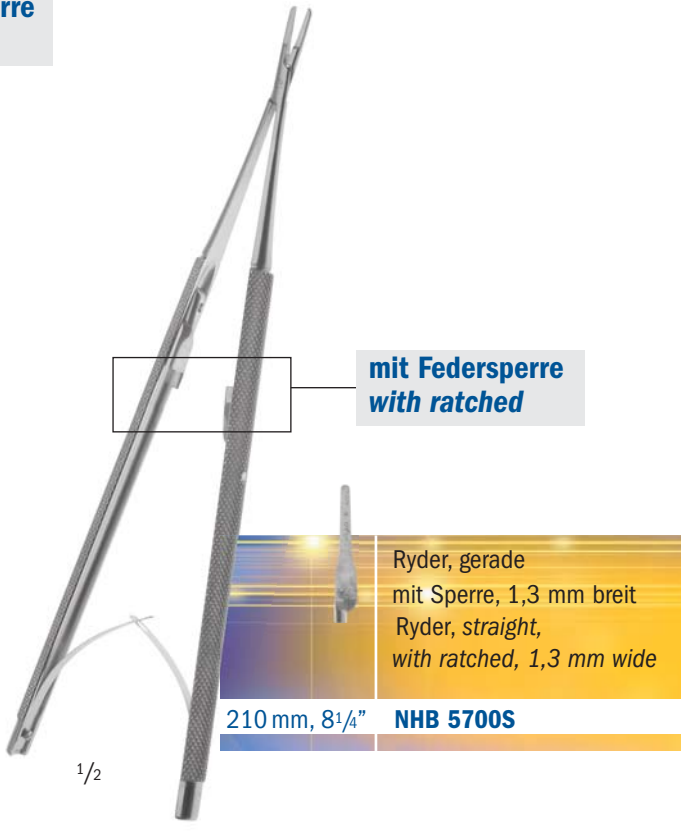

Ryder, gerade mit Sperre, 1,3 mm breit Ryder, straight, with ratched, 1,3 mm wide	210 mm, 8 1/4" <b>NHB 5700S</b>
--	---------------------------------



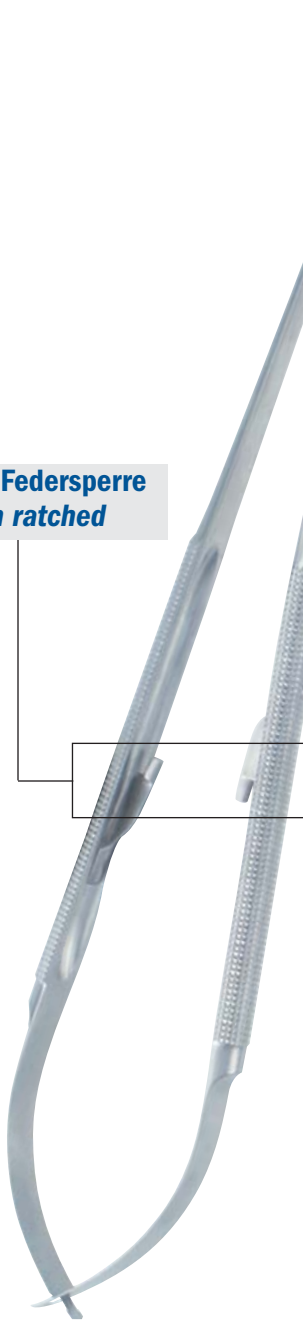

mit Federsperre  
with ratched

1/2





mit Federsperre  
with ratched



MICRO

					
<b>mit Sperre with ratched</b>	gerade straight ↙ 7-0 >	gebogen curved ↙ 7-0 >	gerade straight ↙ 5-0 >	gebogen curved ↙ 5-0 >	gerade straight ↙ 4-0 >
185 mm, 7"	<b>MN 1346D</b>	<b>MN 1347D</b>	<b>MN 1340D</b>	<b>MN 1341D</b>	
210 mm, 8 1/4"	<b>MN 1348D</b>	<b>MN 1349D</b>	<b>MN 1344D</b>	<b>MN 1345D</b>	<b>MN 1351D</b>
230 mm, 9"	<b>MN 1352D</b>	<b>MN 1353D</b>	<b>MN 1354D</b>	<b>MN 1355D</b>	
<b>ohne Sperre without ratched</b>	gerade straight ↙ 7-0 >	gebogen curved ↙ 7-0 >	gerade straight ↙ 5-0 >	gebogen curved ↙ 5-0 >	
185 mm, 7"	<b>MN 1320D</b>	<b>MN 1330D</b>	<b>MN 1332D</b>	<b>MN 1333D</b>	
210 mm, 8 1/4"	<b>MN 1342D</b>	<b>MN 1343D</b>	<b>MN 1334D</b>	<b>MN 1335D</b>	
250 mm, 10"			<b>MN 1338D</b>	<b>MN 1339D</b>	

glatt /  
smooth

					
<b>mit Sperre with ratched</b>	gerade straight ↙ 7-0 >	gebogen curved ↙ 7-0 >	gerade straight ↙ 5-0 >	gebogen curved ↙ 5-0 >	
150 mm, 6"	<b>MN 1300</b>	<b>MN 1310</b>			
230 mm, 9"	<b>MN 1352</b>	<b>MN 1353</b>	<b>MN 1354</b>	<b>MN 1355</b>	
<b>ohne Sperre without ratched</b>	gerade straight ↙ 7-0 >	gebogen curved ↙ 7-0 >	gerade straight ↙ 5-0 >	gebogen curved ↙ 5-0 >	gerade straight ↙ 4-0 >
185 mm, 7"	<b>MN 1320</b>	<b>MN 1330</b>	<b>MN 1332</b>	<b>MN 1333</b>	
210 mm, 8 1/4"	<b>MN 1342</b>	<b>MN 1343</b>	<b>MN 1334</b>	<b>MN 1335</b>	<b>MN 1351</b>
250 mm, 10"			<b>MN 1338</b>	<b>MN 1339</b>	

**Diamond  
Dust tip**

**Streamline  
Boxlock**



	MICRO SLIM LINE ↗ 8-0 >	MICRO SLIM LINE ↗ 7-0 >	SLIM LINE ↗ 5-0 >	MEDIUM LINE ↗ 4-0 >	MAKRO LINE TIGER ↗ 2-0 >	mit Sperre with ratched	ohne Sperre without ratched
150 mm, 6"		<b>NHB 5127S</b>	<b>NHB 5125S</b>			●	
150 mm, 6"		<b>NHB 5127</b>	<b>NHB 5125</b>				●
180 mm, 7"	<b>NHB 5148S</b>	<b>NHB 5147S</b>	<b>NHB 5145S</b>			●	
180 mm, 7"	<b>NHB 5148</b>	<b>NHB 5147</b>	<b>NHB 5145</b>				●
190 mm, 7 1/2"		<b>NHB 5357S</b>		<b>NHB 5354S</b>	<b>NHB 5141S</b>	●	
190 mm, 7 1/2"		<b>NHB 5357</b>		<b>NHB 5354</b>	<b>NHB 5141</b>		●
205 mm, 8"	<b>NHB 5158S</b>	<b>NHB 5157S</b>	<b>NHB 5155S</b>			●	
205 mm, 8"	<b>NHB 5158</b>	<b>NHB 5157</b>	<b>NHB 5155</b>				●
230 mm, 9"	<b>NHB 5188S</b>	<b>NHB 5187S</b>	<b>NHB 5185S</b>		<b>NHB 5191S</b>	●	
230 mm, 9"	<b>NHB 5188</b>	<b>NHB 5187</b>	<b>NHB 5185</b>		<b>NHB 5191</b>		●
230 mm, 9" (curved)		<b>NHB 5287S</b>				●	
250 mm, 10"	<b>NHB 5198S</b>	<b>NHB 5197S</b>	<b>NHB 5195S</b>		<b>NHB 5194S</b>	●	
250 mm, 10"	<b>NHB 5198</b>	<b>NHB 5197</b>	<b>NHB 5195</b>		<b>NHB 5194</b>		●

**ONIX**

	<b>gebogen, mit Sperre curved, with ratched</b>	↗ 7-0 >
300 mm, 12"	<b>NHB 5201S</b>	

**Diamond  
Dust tip**

	gerade mit Sperre straight with ratched ↕ 7-0 >	gebogen mit Sperre curved with ratched ↕ 7-0 >	gerade ohne Sperre straight without ratched ↕ 7-0 >	gebogen ohne Sperre curved without ratched ↕ 7-0 >
210 mm, 8 1/4"	<b>NHB 7088S</b>	<b>NHB 7089S</b>	<b>NHB 7088</b>	<b>NHB 7089</b>

**MICRO-CARDIO**

**TITANIT®**

mit Sperre with ratched	glatt, gerade smooth, straight ↕ 6-0 >	TITANIT® glatt, gerade smooth, straight ↕ 6-0 >
200 mm, 8"	<b>MD 0835</b>	<b>MD 0835T</b>

**ERGONOMY**



<b>Diamond Dust</b>	Ryder, mit Sperre TC ryder tip, TC with ratched ↻ 7/0 - 8/0	mit Sperre gerade with ratched straight ↻ 6/0 - 8/0	ohne Sperre gerade without ratched straight ↻ 6/0 - 8/0	mit Sperre gerade with ratched straight ↻ 5/0 - 8/0	ohne Sperre gerade without ratched straight ↻ 5/0 - 8/0
145 mm, 5 3/4"		<b>NHB 4515S</b>	<b>NHB 4515</b>		
180 mm, 7"		<b>NHB 4525S</b>	<b>NHB 4525</b>	<b>NHB 5554S</b>	
205 mm, 8"		<b>NHB 4535S</b>	<b>NHB 4535</b>	<b>NHB 5555S</b>	<b>NHB 5555</b>
230 mm, 9"	<b>NHB 4597S</b>	<b>NHB 4545S</b>	<b>NHB 4545</b>	<b>NHB 5556S</b>	

TOPAS



<b>POWER-TC</b>	mit Sperre gerade with ratched straight feines TC fine TC	ohne Sperre Delicat 1,0mm without ratched delicate 1,0mm ↻ 7/0 - 10/0	mit Sperre gerade with ratched straight ↻ 5/0 - 6/0	ohne Sperre gerade without ratched straight ↻ 5/0 - 6/0
145 mm, 5 3/4"	<b>NHB 4705S</b>		<b>NHB 4715S</b>	<b>NHB 4715</b>
180 mm, 7"	<b>NHB 4706S</b>	<b>NHB 4627</b>	<b>NHB 4725S</b>	<b>NHB 4725</b>
205 mm, 8"	<b>NHB 4707S</b>		<b>NHB 4735S</b>	<b>NHB 4735</b>
230 mm, 9"	<b>NHB 4708S</b>		<b>NHB 4745S</b>	<b>NHB 4745</b>

TOPAS

<b>gerieftes Maul serrated tip POWER-TC</b> 0,2 Teilung fein	mit Sperre gerade with ratched straight ↻ 5-0 >	mit Sperre gebogen with ratched curved ↻ 5-0 >	mit Sperre gerade with ratched straight ↻ 4-0 >
145 mm, 5 3/4"	<b>NHB 4815S</b>	<b>NHB 4915S</b>	
180 mm, 7"	<b>NHB 4825S</b>	<b>NHB 4925S</b>	
205 mm, 8"	<b>NHB 4835S</b>	<b>NHB 4935S</b>	<b>NHB 4834S</b>
230 mm, 9"	<b>NHB 4845S</b>	<b>NHB 4945S</b>	

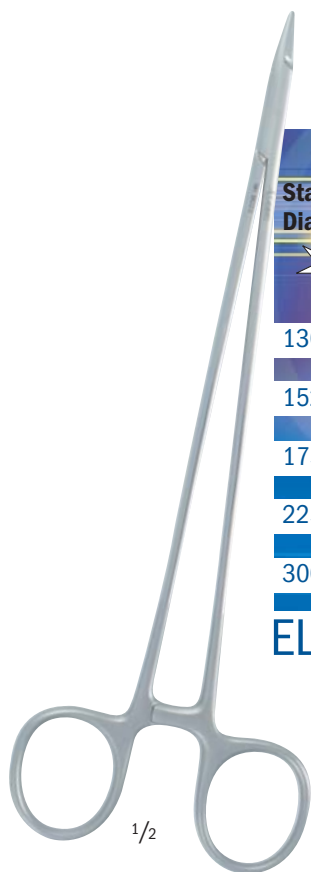

TOPAS

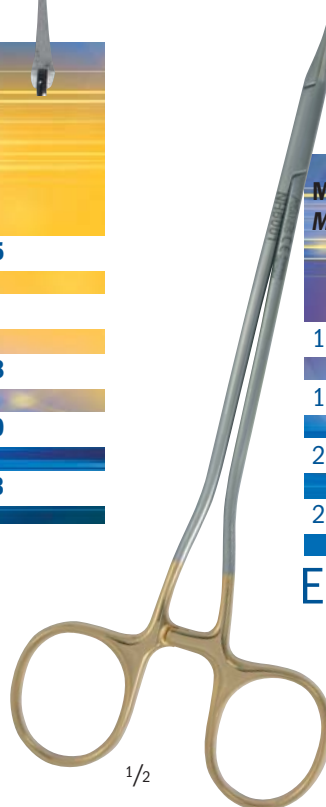

<b>Stahl Steel</b>		
<b>Diamond Dust</b>		MICRO
	 5-0 >	 6-0 >
130 mm, 5"		<b>NH 6015</b>
152 mm, 6"	<b>NH 6016</b>	
175 mm, 7"	<b>NH 6018</b>	<b>NH 6028</b>
225 mm, 9"	<b>NH 6022</b>	<b>NH 6030</b>
300 mm, 12"	<b>NH 6025</b>	<b>NH 6033</b>

**ELEGANCE**



<b>Mikro Nadelhalter</b>		<b>TC</b>
<b>Micro Needle Holder</b>		
	 6-0 >	
150 mm, 6"	<b>NH 6000</b>	
180 mm, 7"	<b>NH 6001</b>	
205 mm, 8"	<b>NH 6002</b>	
230 mm, 9"	<b>NH 6003</b>	<b>NH 6003TC</b>



**EUPHRATE-PASQUE**



<b>Valve Nadelhalter</b>	
<b>Valve Needle Holder</b>	
Stahl steel	 3-0 >
250 mm, 10"	<b>NHB 1004</b>

**STRONG CURVED**



<b>Titanium</b>	
<b>Diamond Dust</b>	
	 6-0 >
125 mm, 5"	<b>NH 8802</b>
145 mm, 5 3/4"	<b>NH 8804</b>
175 mm, 7"	<b>NH 8806</b>
195 mm, 7 3/4"	<b>NH 8808</b>
225 mm, 8 3/4"	<b>NH 8810</b>

**MICRO-TITAN**



	1,0mm glatt/smooth ↗ 7/0 - 8/0	1,0mm gerieft/serrated ↗ 7/0 - 8/0	1,2mm gerieft/serrated ↗ 6/0 - 8/0	1,8mm gerieft/serrated ↗ 4/0 - 6/0
120 mm, 5"	<b>NH 0512</b>	<b>NH 0522</b>	<b>NH 0500</b>	
135 mm, 5 1/4"				<b>NH 0440</b>
150 mm, 6"	<b>NH 0513</b>	<b>NH 0523</b>	<b>NH 0510</b>	<b>NH 0441</b>
180 mm, 7"	<b>NH 0514</b>	<b>NH 0524</b>	<b>NH 0520</b>	<b>NH 0450</b>
200 mm, 8"	<b>NH 0515</b>	<b>NH 0525</b>	<b>NH 0530</b>	<b>NH 0460</b>
230 mm, 9"	<b>NH 0516</b>	<b>NH 0526</b>	<b>NH 0531</b>	<b>NH 0468</b>
260 mm, 10"		<b>NH 0527</b>		
230 mm, 9"				<b>NH 0470</b>

**RYDER**

1/2

	↗ 5/0 - 7/0	↗ 5/0 - 7/0	↗ 5/0 - 7/0	↗ 5/0 - 7/0	↗ 5/0 - 7/0
150 mm, 6"	<b>NH 0328</b>				
180 mm, 7"		<b>NH 0329</b>			
205 mm, 8"			<b>NH 0330</b>		
230 mm, 9"				<b>NH 0332</b>	
270 mm, 10 1/2"					<b>NH 0331</b>

**MICRO VASCULAR**

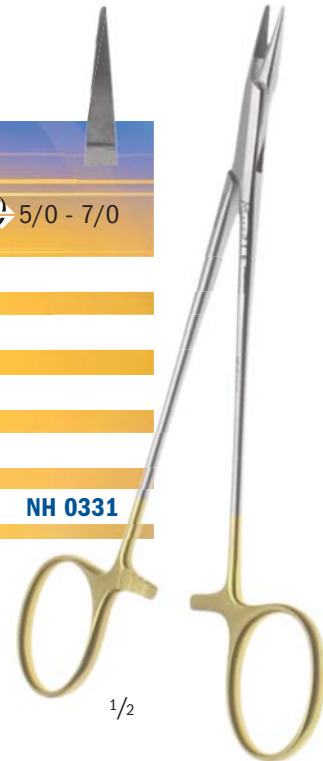

1/2





<b>POWER TC</b> <b>POWER TC</b>	<b>Standard</b> <b>Standard</b>
↻ 4/0 - 6/0	↻ 4/0 - 6/0
120 mm, 4 1/2"	<b>NH 0150</b> <b>NH 1130</b>

**DERF**

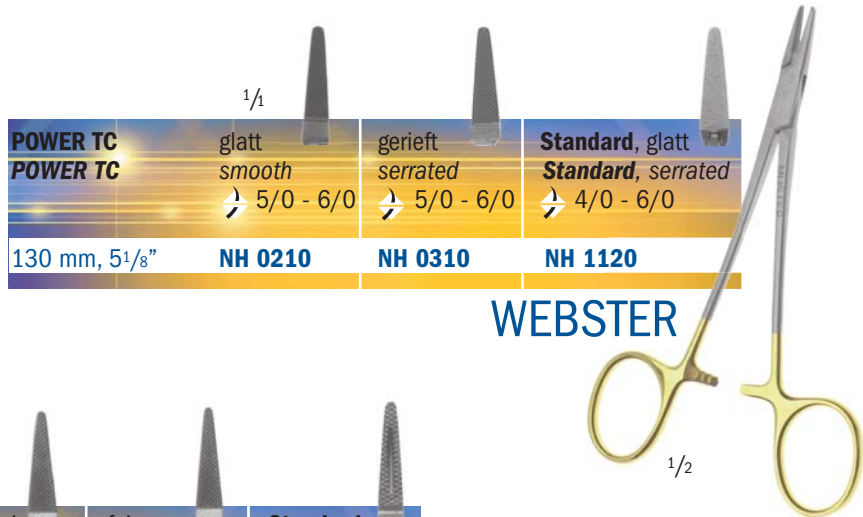

<b>POWER TC</b> <b>POWER TC</b>	glatt smooth	gerieft serrated	<b>Standard, glatt</b> <b>Standard, serrated</b>
↻ 5/0 - 6/0	↻ 5/0 - 6/0	↻ 4/0 - 6/0	
130 mm, 5 1/8"	<b>NH 0210</b>	<b>NH 0310</b>	<b>NH 1120</b>

**WEBSTER**





<b>POWER TC</b> <b>POWER TC</b>	normal normal	fein delicate	<b>Standard</b> <b>Standard</b>
↻ 5/0 - 6/0	↻ 5/0 - 6/0	↻ 4/0 - 6/0	
150 mm, 6"	<b>NH 0200</b>	<b>NH 0200-1</b>	<b>NH 1180</b>

**BABY CRILE-WOOD**









<b>POWER TC</b> <b>POWER TC</b>	↻ 4/0 - 6/0	↻ 4/0 - 6/0	↻ 4/0 - 6/0	↻ 4/0 - 6/0	↻ 4/0 - 6/0
150 mm, 6"	<b>NH 0230</b>				
150 mm, 6"	<b>NH 0230F</b>	ohne Sperre/without ratchet			
150 mm, 6"	<b>NH 1200</b>	Stahl /steel			
180 mm, 7"	<b>NH 0240</b>				
200 mm, 8"	<b>NH 0260</b>				
230 mm, 9"	<b>NH 0265</b>				
305 mm, 12"	<b>NH 0280</b>				



**CRILE-WOOD**

	1/1		
			
	↻ 5/0 - 7/0	↻ 5/0 - 7/0	↻ 5/0 - 7/0
165 mm, 6 1/2"	<b>NH 0360</b>		
180 mm, 7"		<b>NH 0361</b>	
210 mm, 8 1/4"			<b>NH 0370</b>

**DE BAKEY**

	1/1					
<b>POWER TC</b>						
<b>POWER TC</b>	↻ 4/0 - 6/0	↻ 4/0 - 7/0	↻ 4/0 - 7/0	↻ 4/0 - 7/0	↻ 4/0 - 7/0	↻ 4/0 - 7/0
150 mm, 6"	<b>NH 0350</b>					
180 mm, 7"		<b>NH 0380</b>				
180 mm, 7"		<b>NH 0380F</b> ohne Sperre/without ratchet				
205 mm, 8"			<b>NH 0385</b>			
230 mm, 9"				<b>NH 0390</b>		
265 mm, 10"					<b>NH 0400</b>	
305 mm, 12"						<b>NH 0410</b>

**DE BAKEY**

	1/1	
<b>POWER TC</b>		
<b>POWER TC</b>	↻ 4/0 - 6/0	↻ 5/0 - 6/0
180 mm, 7"	<b>NH 0270</b>	
255 mm, 10"		<b>NH 0300</b>

**SAROT**

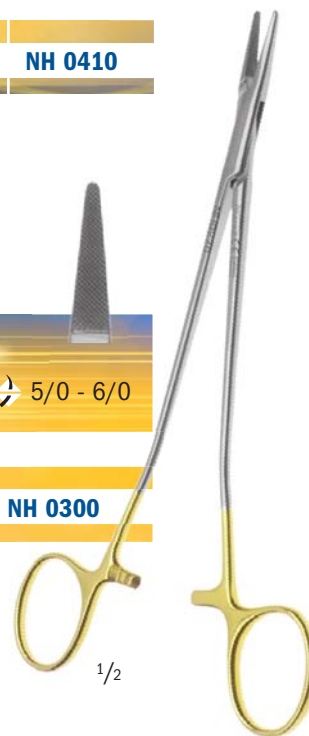
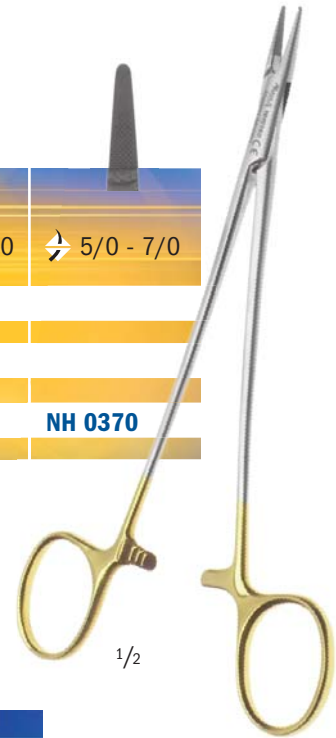

	$\frac{1}{4}$						
<b>POWER TC</b> <b>POWER TC</b> ↻ 3/0 - 5/0							
130 mm, 5"	<b>NH 0431</b>						
150 mm, 6"	<b>NH 0432</b>						
180 mm, 7"	<b>NH 0433</b>						
205 mm, 8"	<b>NH 0434</b>						
230 mm, 9"	<b>NH 0435</b>						
255 mm, 10"	<b>NH 0436</b>						

**RYDER "FRENCH EYE"**



	$\frac{1}{4}$
<b>POWER TC</b> <b>POWER TC</b> ↻ 2/0 - 4/0	
150 mm, 6"	<b>NH 0560</b>

**MAYO-HEGAR**

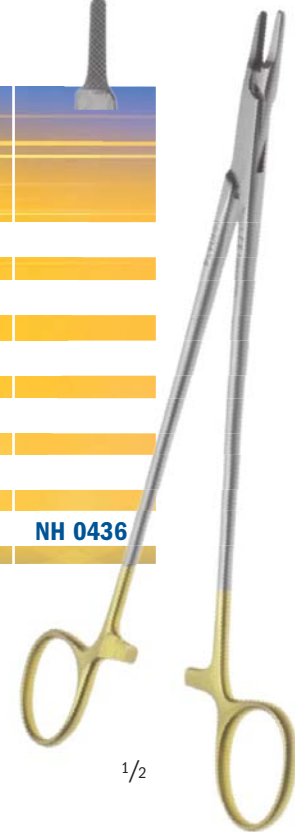

	$\frac{1}{4}$								
<b>POWER TC</b> <b>POWER TC</b> ↻ 1/0 - 4/0									
180 mm, 7"	<b>NH 0570</b>								
205 mm, 8"	<b>NH 0580</b>								
240 mm, 9 $\frac{1}{2}$ "	<b>NH 0575</b>								
265 mm, 10"	<b>NH 0576</b>								
300 mm, 12"	<b>NH 0590</b>								
350 mm, 14"	<b>NH 0595</b>								
400 mm, 16"	<b>NH 0596</b>								

**MAYO-HEGAR**

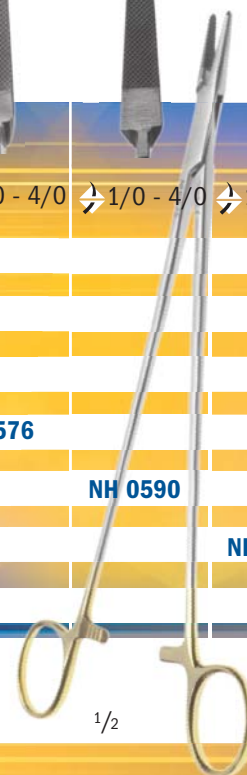



**POWER TC, S-gebogen**  
**POWER TC, S-curved**

1/1

↗ 4/0 - 7/0

↗ 4/0 - 7/0

↗ 4/0 - 7/0

↗ 4/0 - 7/0

210 mm, 8<sup>1</sup>/<sub>4</sub>" **NH 0740**

240 mm, 9<sup>1</sup>/<sub>2</sub>" **NH 0742**

260 mm, 10<sup>1</sup>/<sub>4</sub>" **NH 0743**

300 mm, 12" **NH 0745**

**BOZEMANN**

**für starke Nadeln**  
**for strong sutures**

1/1

↗ 0/0 - 2/0

↗ 0/0 - 2/0

↗ 0/0 - 2/0

180 mm, 7" **NH 2056**

200 mm, 8" **NH 2057**

225 mm, 9" **NH 2058**

**HAJEK**

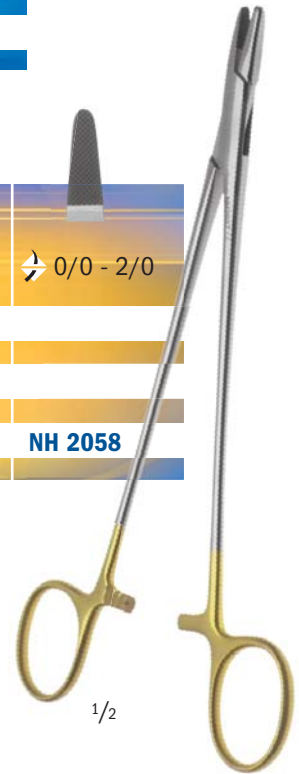

**für starke Nadeln**  
**for strong suture**

1/1

↗ 0/0 - 2/0

260 mm, 10<sup>1</sup>/<sub>4</sub>" **NH 2060**

**HAJEK**

**für starke Nadeln**  
**for strong suture**

1/1

↗ 1/0 - 4/0

255 mm, 10" **NH 2050**

**HAJEK**

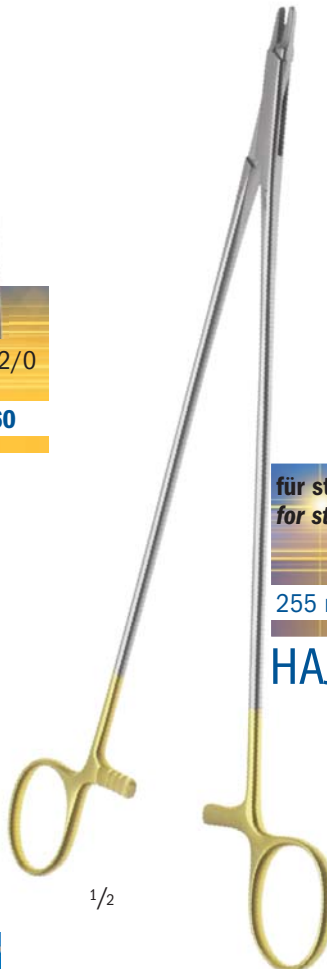
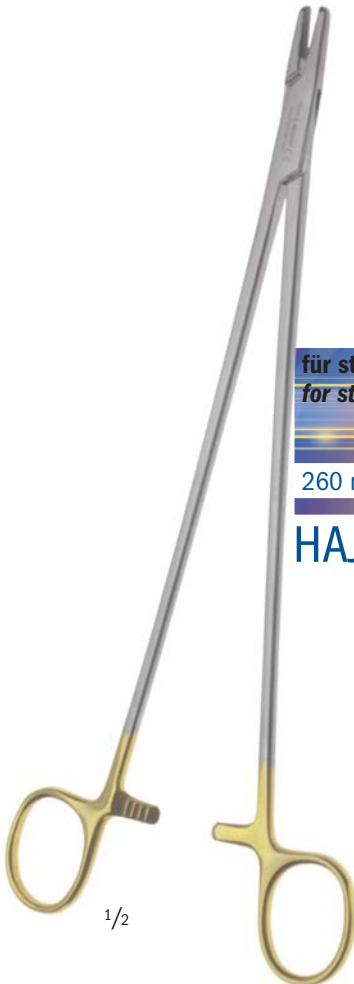

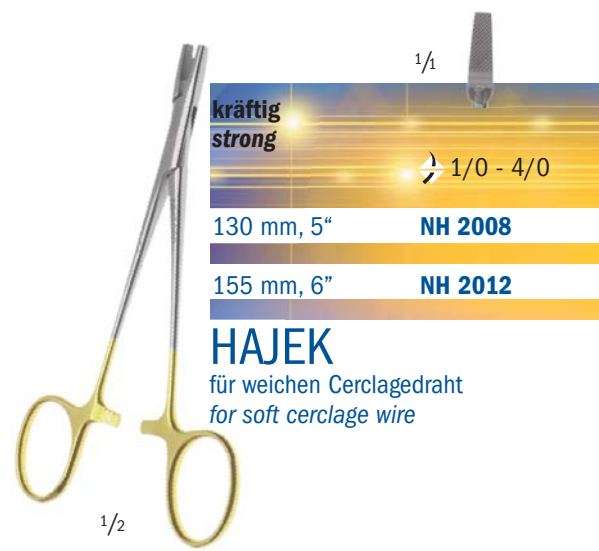

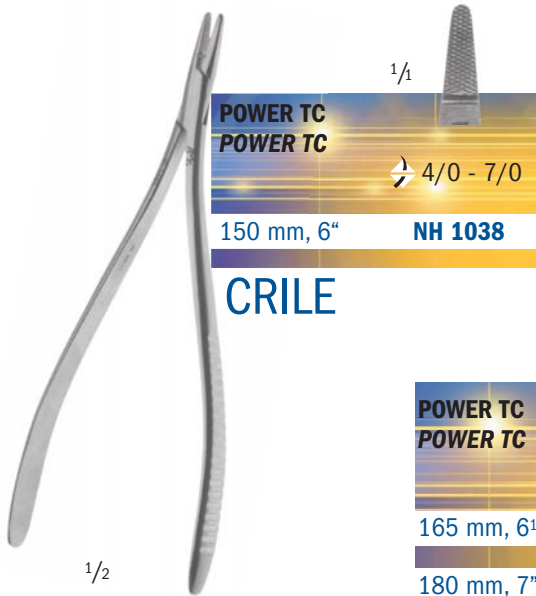

**POWER TC**  
**POWER TC**  
1/1  
4/0 - 7/0  
150 mm, 6" **NH 1038**

**CRILE**

1/1	4/0 - 6/0	4/0 - 6/0	4/0 - 6/0	4/0 - 6/0
165 mm, 6 1/2"	<b>NH 1068</b>			
180 mm, 7"		<b>NH 1069</b>		
200 mm, 8"			<b>NH 1070</b>	
230 mm, 9"				<b>NH 1071</b>

**LANGENBECK**



1/2

1/1	4/0 - 6/0	4/0 - 6/0	3/0 - 5/0
140 mm, 5 1/2"	<b>NH 0870</b>		
170 mm, 6 3/4"		<b>NH 0890</b>	
200 mm, 8"			<b>NH 0910</b>

**MATHIEU-KOCHER**

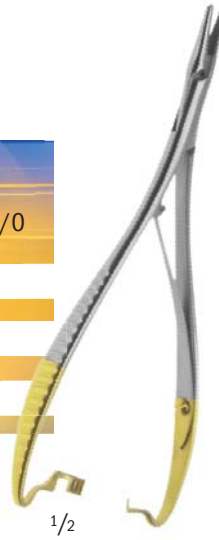

1/2

1/1	4/0 - 6/0	4/0 - 6/0	4/0 - 6/0
170 mm, 6 3/4"	<b>NH 0931</b>		
200 mm, 8"		<b>NH 0932</b>	
220 mm, 8 1/2"			<b>NH 0933</b>

**MATHIEU**



1/2

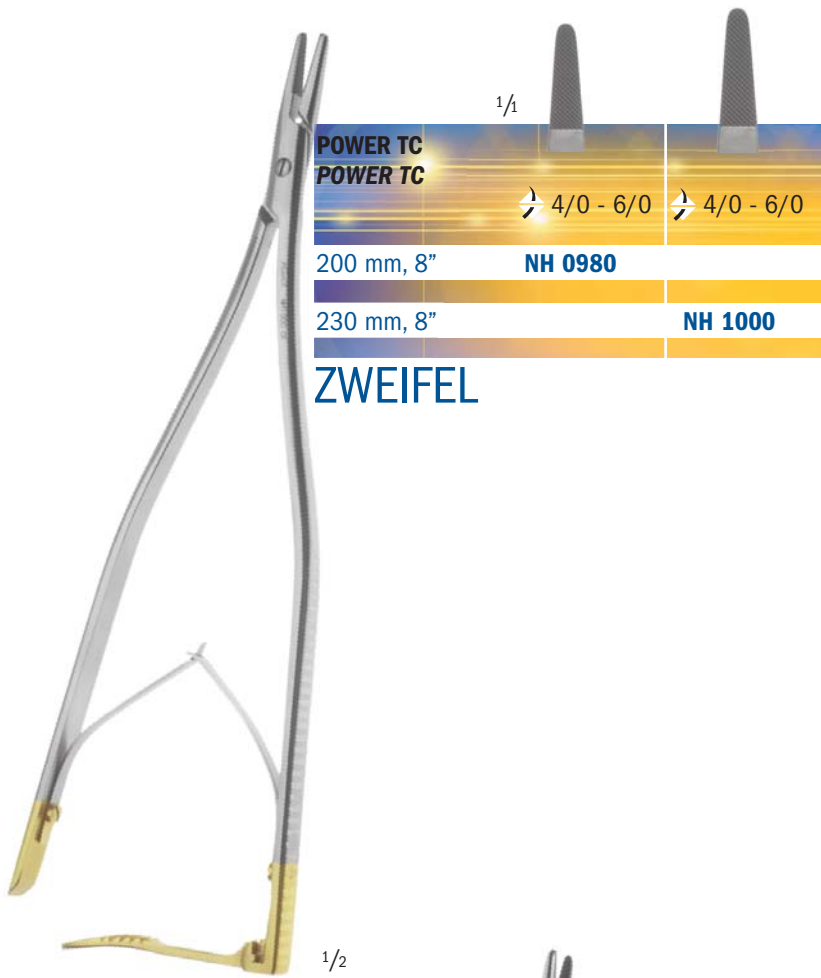

	<sup>1/1</sup>	<sup>1/1</sup>
<b>POWER TC</b>		
<b>POWER TC</b>	↗ 4/0 - 6/0	↗ 4/0 - 6/0
200 mm, 8"	<b>NH 0980</b>	
230 mm, 8"		<b>NH 1000</b>

**ZWEIFEL**

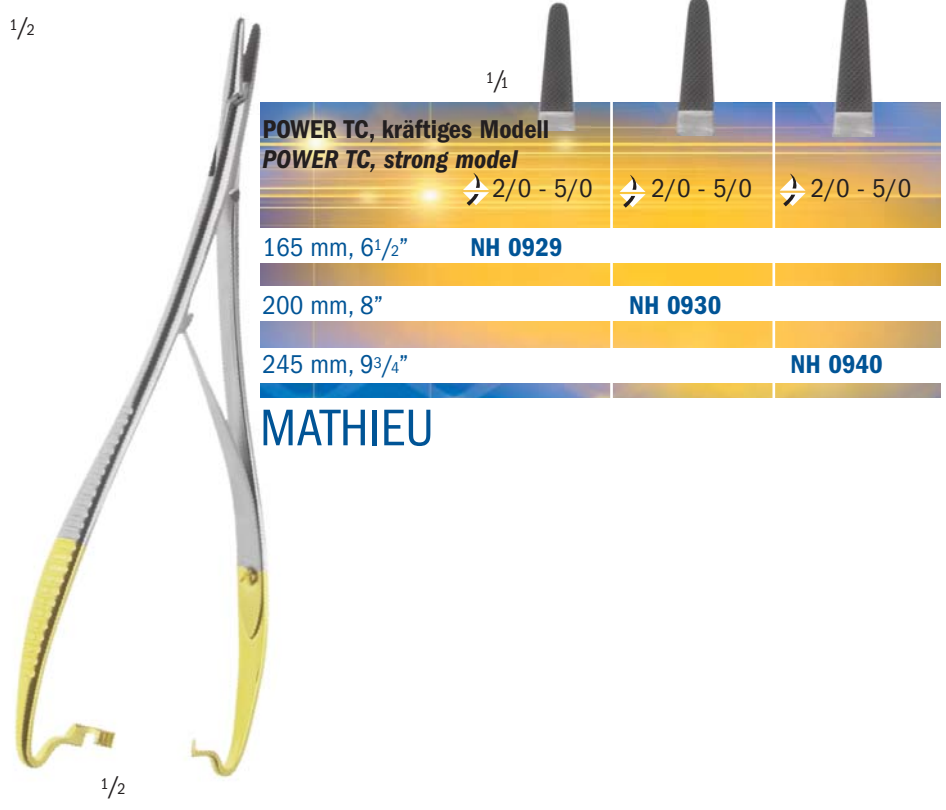

	<sup>1/1</sup>	<sup>1/1</sup>	<sup>1/1</sup>
<b>POWER TC, kräftiges Modell</b>			
<b>POWER TC, strong model</b>	↗ 2/0 - 5/0	↗ 2/0 - 5/0	↗ 2/0 - 5/0
165 mm, 6 <sup>1/2</sup> "	<b>NH 0929</b>		
200 mm, 8"		<b>NH 0930</b>	
245 mm, 9 <sup>3/4</sup> "			<b>NH 0940</b>

**MATHIEU**





# PINZETTEN FORCEPS



1 mm	4 mm	mit Gegengewicht gerade counterbalance straight	ohne Gegengewicht gerade light weight straight	mit Gegengewicht gebogen counterbalance curved
160 mm, 6 <sup>1</sup> / <sub>4</sub> "	4 mm	GF 8019	GF 8119	
160 mm, 6 <sup>1</sup> / <sub>4</sub> "	1 mm	GF 8020	GF 8120	GF 8071
185 mm, 7 <sup>1</sup> / <sub>4</sub> "	1 mm	GF 8021	GF 8121	GF 8025
210 mm, 8 <sup>1</sup> / <sub>2</sub> "	1 mm	GF 8023	GF 8123	
230 mm, 9"	1 mm	GF 8024		
250 mm, 10"	1 mm	GF 8029		

### DE BAKEY

mit feinem Plateau with delicate Plateau	gerade mit Gegengew. straight counterbalance	gerade ohne Gegengew. straight light weight	gerade, sehr fein ohne Gegengew. straight, delicate light weight	gebogen mit Gegengew. curved counterbalance	gebogen ohne Gegengew. curved light weight	kräftig 2 mm mit Gegengew. strong 2 mm counterbalance
145 mm, 5 <sup>3</sup> / <sub>4</sub> "	GF 8044					
160 mm, 6 <sup>1</sup> / <sub>4</sub> "	GF 8046	GF 8146		GF 8047	GF 8147	
185 mm, 7 <sup>1</sup> / <sub>4</sub> "	GF 8048	GF 8148		GF 8049	GF 8149	
210 mm, 8 <sup>1</sup> / <sub>2</sub> "	GF 8050	GF 8150	GF 8060	GF 8051	GF 8151	GF 8080
230 mm, 9"		GF 8152		GF 8153		
250 mm, 10"		GF 8154				

### PLATEAU

mit Ring with ring	Small Ø 0,6 x 1,2 mit Gegengew. mit Plateau counterbalance with plateau	Delicate Ø 0,9 x 0,4 ohne Gegengew. mit Plateau light weight with plateau	Small Ø 0,6 x 1,2 ohne Gegengew. ohne Plateau light weight without plateau	Small Ø 0,6 x 1,2 ohne Gegengew. mit Plateau light weight with plateau	Medium Ø 1,2 x 1,8 mit Gegengew. counterbalance	Medium Ø 1,2 x 1,8 ohne Gegengew. light weight
150 mm, 6"	GF 8002			GF 8102	GF 8003	GF 8103
160 mm, 6 <sup>1</sup> / <sub>4</sub> "	GF 8004			GF 8104	GF 8005	GF 8105
180 mm, 7"	GF 8001	GF 8030	GF 8101-1	GF 8101	GF 8000	GF 8100
210 mm, 8 <sup>1</sup> / <sub>2</sub> "	GF 8010			GF 8110	GF 8011	GF 8111
230 mm, 9"	GF 8012			GF 8112	GF 8016	
250 mm, 10"	GF 8013			GF 8113	GF 8018	
300 mm, 12"	GF 8022					

### RINGTIP

onto request Ring Tips also in Large (1,8 x 2,5) available

ohne Plateau without Plateau	gerade straight
115 mm, 4½"	<b>MN 8502</b>
185 mm, 7"	<b>GF 8148-1</b>
210 mm, 8½"	<b>GF 8150-1</b>
230 mm, 9"	<b>GF 8152-1</b>
250 mm, 10"	<b>GF 8154-1</b>

**SMOOTH**

1mm Spitze 1 mm tip	gerade straight
210 mm, 8½"	<b>GF 8191</b>

**GERALD**

	gerade mit Gegengew. straight counterbalance	gerade ohne Gegengew. straight light weight	Ø 0,3 x 0,7 mit Mikroring mit Gegengew. with Micro-Rintip counterbalance
150 mm, 6"	<b>GF 8026</b>	<b>GF 8036</b>	
160 mm, 6½"		<b>GF 8035</b>	
185 mm, 7¼"	<b>GF 8027</b>	<b>GF 8037</b>	
210 mm, 9¼"	<b>GF 8028</b>	<b>GF 8038</b>	<b>GF 8009</b>

**ASANUS  
 COMBI-SPECIAL**

Knüpf- u. Nahtpinzetten  
 Suture and Tying Forceps

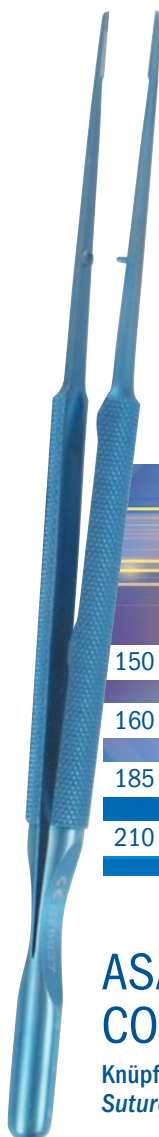

<b>atraumatisch</b> <b>atraumatic</b>	
250 mm, 10"	<b>GF 8158</b>
300 mm, 12"	<b>GF 8160</b>

**RESANO  
CROSS-ACTION**







<b>mit Ring</b> <b>with ring</b>	<b>gerade</b> <b>straight</b>	
185 mm, 7"	<b>GF 8014</b>	
210 mm, 8 1/2"	<b>GF 8015</b>	

**ELEGANCE  
SURE GRIP  
CROSS-ACTION**

für Off-Pump- und in der tiefen Chirurgie gewährleistet höheren Druck auf die Arbeitsenden bei weniger Kraftaufwand

*for off pump and deep surgery more compression allows optimal indications by lesser force*



	<b>Knüpfpinzette</b> <b>tying forcep</b>			
250 mm, 10"	<b>GF 8129</b>			
305 mm, 12"	<b>GF 8130</b>			
305 mm, 12"				<b>GF 8131</b>

**ELEGANCE  
CROSS-ACTION**



**mit Ring**  
**with Ring**

Ø 1,2 x 1,8 mm  
Bajonett gebogen,  
mit Rundgriff  
*Bajonett shaped, curved  
with round handle*

200 mm, 8" **PZ 8005**

**WAHL**

für feines Gewebe  
*for soft tissue*

**mit Plateau**  
fein, gerade  
**with plateau**  
*fine, straight*

180 mm, 7" **GF 8031**

200 mm, 8" **GF 8032**

**MICRO DELICATE**

für die Präparation der  
Mammaria Arterie

*for dissection and preparation of  
Mammaria Arteria*



gerade  
*straight*

200 mm, 8" **GF 8890**

240 mm, 9 1/2" **GF 8892**

**ANATOMIC**

De Bakey Atraumatic gerade <i>De Bakey Atraumatic straight</i>	Knüpfplateau gerade <i>tying tip straight</i>	Ringtip gerade <i>Ringtip straight</i>
--	---	--

185 mm, 7" **GF 8189** **GF 8017**

210 mm, 8 1/4" **GF 8190** **GF 8196**

**GERALD**



	fein, bajonett gebogen <i>fine bajonette shape 0,7 mm</i>	sehr fein, gerade <i>delicate straight 1,1 mm</i>
220 mm, 8 3/4"	<b>MN 8660</b>	<b>MN 8661</b>



<b>1 x 2 Zähne gerade 1 x 2 teeth straight</b>	0,6 mm Maul tip	1,0 mm Maul tip	1,5 mm Maul tip
150 mm, 6"	<b>MN 8085</b>	<b>MN 8086</b>	
160 mm, 6"	<b>MN 8087</b> (Flachgriff/flat handle)		
210 mm, 8 1/4"			<b>GF 8058</b>



**mit Gegengewicht  
with Counter Balance**

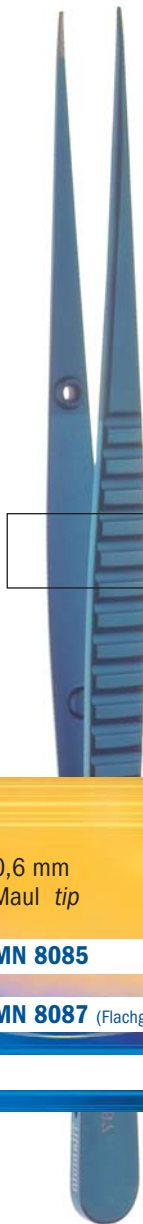

**Flachgriff  
flat handle**

	gerade <i>straight</i>
150 mm, 6"	<b>GF 8175</b>
190 mm, 7 1/2"	<b>GF 8170</b>

**MC INDOE**



**LINZ**

	gerade straight Flat tip Diamond Dust tip	gerade straight De Bakey tip atraumatic	gerade straight Ring tip Diamond Dust tip
185 mm, 7"	<b>GFB 4318</b>	<b>GFB 4518</b>	<b>GFB 4418</b>
210 mm, 8 1/4"	<b>GFB 4321</b>	<b>GFB 4521</b>	<b>GFB 4421</b>
230 mm, 9"	<b>GFB 4323</b>	<b>GFB 4523</b>	<b>GFB 4423</b>

**GERALD**

Nahtpinzette Needle Pulling Forceps POWER-TC	1,5 mm Breite width	2,0 mm Breite width	2,7 mm Breite width	3,5 mm Breite width
160 mm, 6 1/4"	<b>PZ 0416</b>	<b>PZ 0426</b>	<b>PZ 0436</b>	<b>PZ 0446</b>
200 mm, 8"	<b>PZ 0417</b>	<b>PZ 0427</b>	<b>PZ 0437</b>	<b>PZ 0447</b>
240 mm, 9"	<b>PZ 0418</b>	<b>PZ 0428</b>	<b>PZ 0438</b>	<b>PZ 0448</b>

**ASANUS DE BAKEY-COMBI**



mit Ring Ø 1,0 x 0,5 mm ohne Plateau with ring Ø 1,0 x 0,5 mm without plateau	mit Gegengewicht gerade with counterbalance straight	mit Gegengewicht gebogen with counterbalance curved	ohne Gegengewicht gerade light weight straight	ohne Gegengewicht gerade light weight straight
150 mm, 6"	GFB 5315	GFB 5315-1	GFB 5115	
185mm, 7 1/4"	GFB 5318	GFB 5318-1	GFB 5118	
210 mm, 8 1/2"	GFB 5321	GFB 5321-1	GFB 5121	GFB5121-1
230 mm, 9"	GFB 5323	GFB 5323-1	GFB 5123	
250 mm, 10"	GFB 5325	GFB 5325-1	GFB 5125	

### RINGTIP



mit feinem Plateau with delicate plateau	mit Gegengewicht gerade with counterbalance straight	mit Gegengewicht gebogen with counterbalance curved	ohne Gegengewicht gerade light weight straight	ohne Gegengewicht gebogen light weight curved
150 mm, 6"	GFB 6215	GFB 6215-1	GFB 6315	
180 mm, 7"	GFB 6218	GFB 6218-1	GFB 6318	GFB 6618
210 mm, 8 1/2"	GFB 6221	GFB 6221-1	GFB 6321	GFB 6621
230 mm, 9"	GFB 6223	GFB 6223-1	GFB 6323	
250 mm, 10"	GFB 6225	GFB 6225-1	GFB 6325	

### PLATEAU

	mit Gegengewicht with counterbalance	ohne Gegengewicht light weight
185mm, 7 1/4"	GFB 5518	GFB 6518
210 mm, 8 1/2"	GFB 5521	GFB 6521
230 mm, 9"	GFB 5523	GFB 6523
250 mm, 10"	GFB 5525	GFB 6525

### DE BAKEY



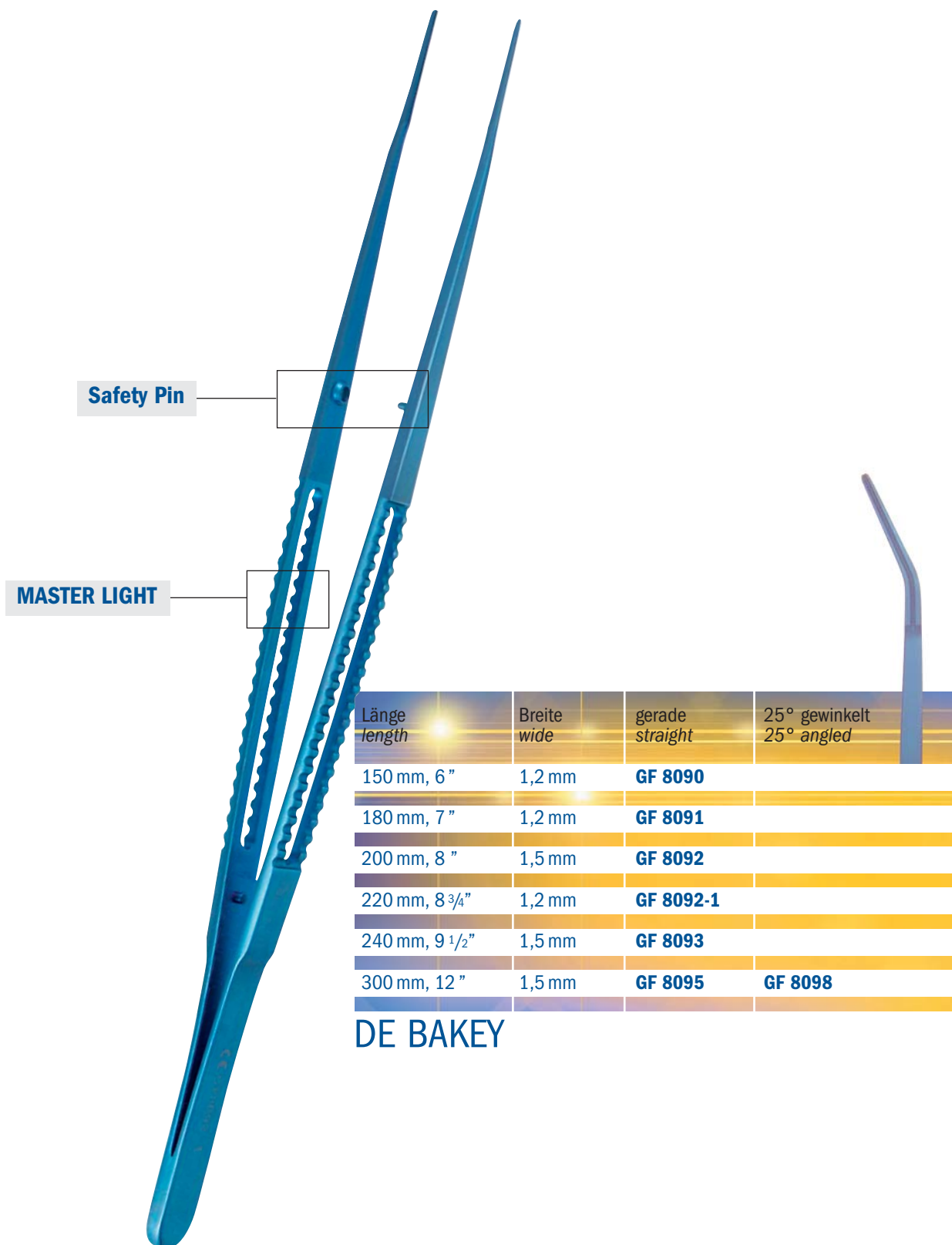

Länge <i>length</i>	Breite <i>wide</i>	gerade <i>straight</i>	25° gewinkelt <i>25° angled</i>
150 mm, 6"	1,2 mm	<b>GF 8090</b>	
180 mm, 7"	1,2 mm	<b>GF 8091</b>	
200 mm, 8"	1,5 mm	<b>GF 8092</b>	
220 mm, 8 3/4"	1,2 mm	<b>GF 8092-1</b>	
240 mm, 9 1/2"	1,5 mm	<b>GF 8093</b>	
300 mm, 12"	1,5 mm	<b>GF 8095</b>	<b>GF 8098</b>

DE BAKEY

<b>gerade straight</b>		
Länge length	Breite wide	Artikel Nr. order no.
150 mm, 6"	1,0 mm	<b>GF 8739</b>
	1,5 mm	<b>GF 8830</b>
	2,0 mm	<b>GF 8740</b>
	2,9 mm	<b>GF 8790</b>
155 mm, 6"	2,5 mm	<b>GF 8778</b>
185 mm, 7"	1,5 mm	<b>GF 8832</b>
	2,5 mm	<b>GF 8780</b>
200 mm, 8"	1,0 mm	<b>GF 8820</b>
	2,0 mm	<b>GF 8760</b>
	2,9 mm	<b>GF 8791</b>
	3,5 mm	<b>GF 8800</b>
210 mm, 8 1/4"	2,5 mm	<b>GF 8781</b>
240 mm, 9 1/2"	1,0 mm	<b>GF 8824</b>
	1,5 mm	<b>GF 8835</b>
	2,5 mm	<b>GF 8782</b>
	2,9 mm	<b>GF 8792</b>
	3,5 mm	<b>GF 8810</b>
300 mm, 12"	2,0 mm	<b>GF 8763</b>
	2,9 mm	<b>GF 8793</b>
	4,0 mm	<b>GF 8794</b>

**DE BAKEY**

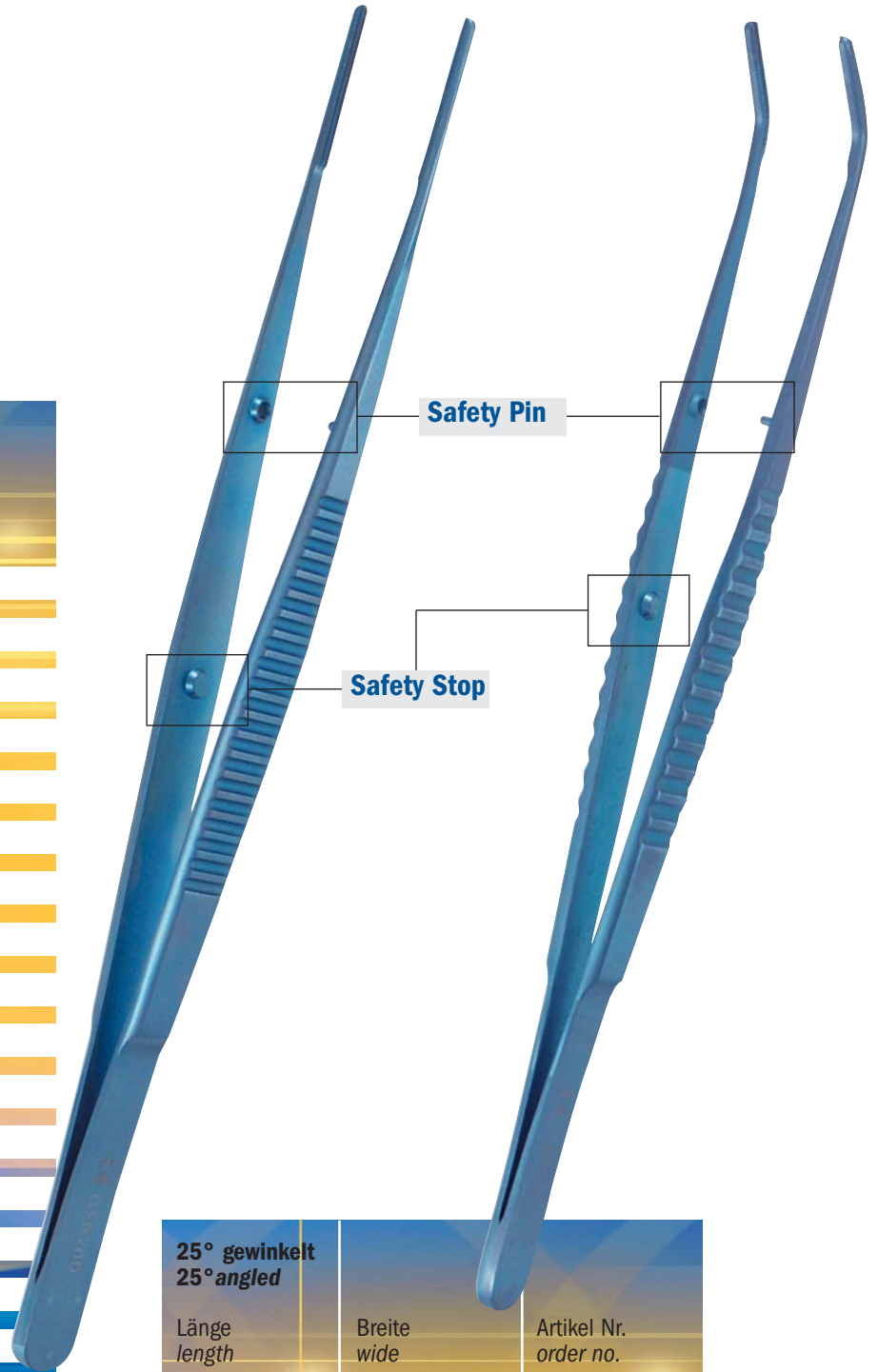

<b>25° gewinkelt 25° angled</b>		
Länge length	Breite wide	Artikel Nr. order no.
150 mm, 6"	2,0 mm	<b>GF 8750</b>
	2,5 mm	<b>GF 8785</b>
185 mm, 7"	2,5 mm	<b>GF 8787</b>
200 mm, 8"	2,0 mm	<b>GF 8770</b>
240 mm, 9 1/2"	2,5 mm	<b>GF 8788</b>

**DE BAKEY**

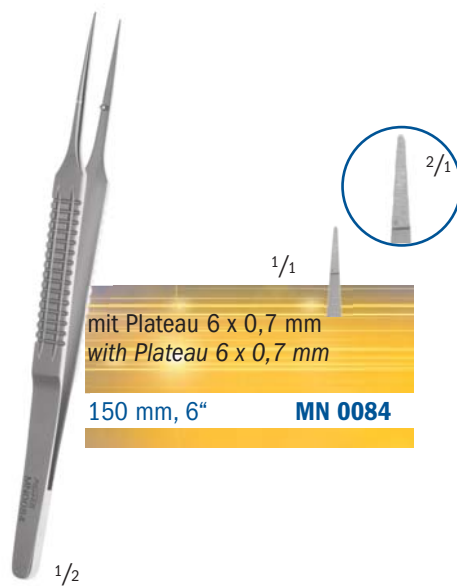
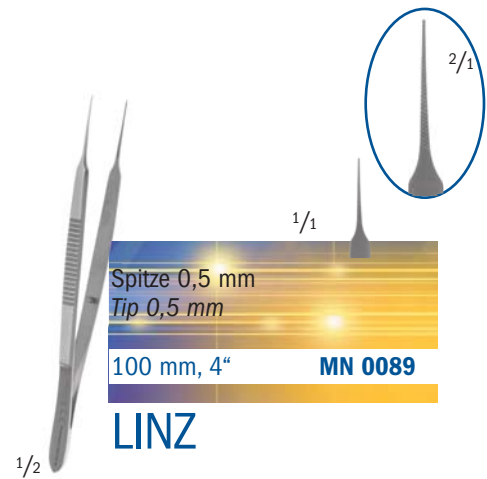
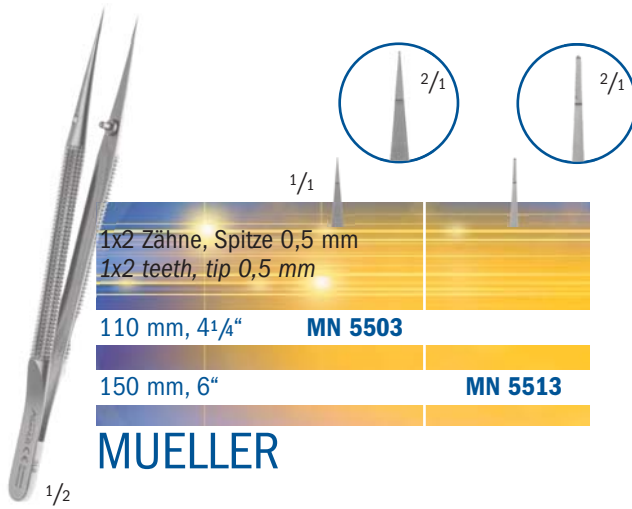

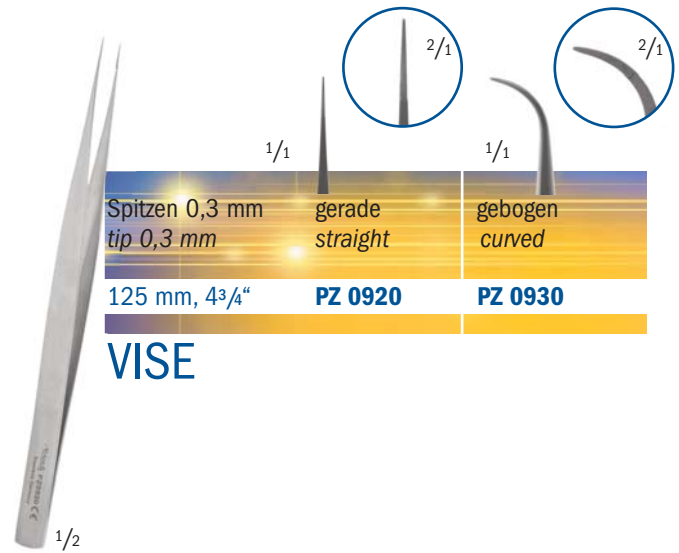
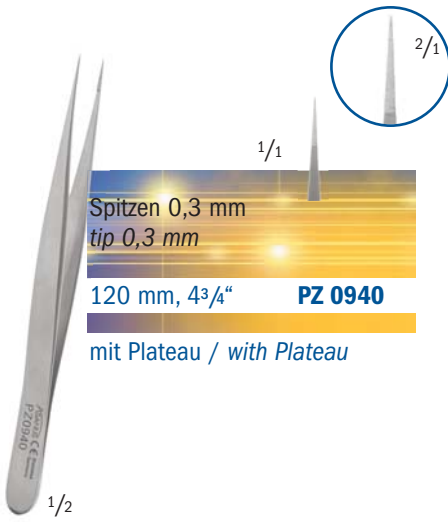

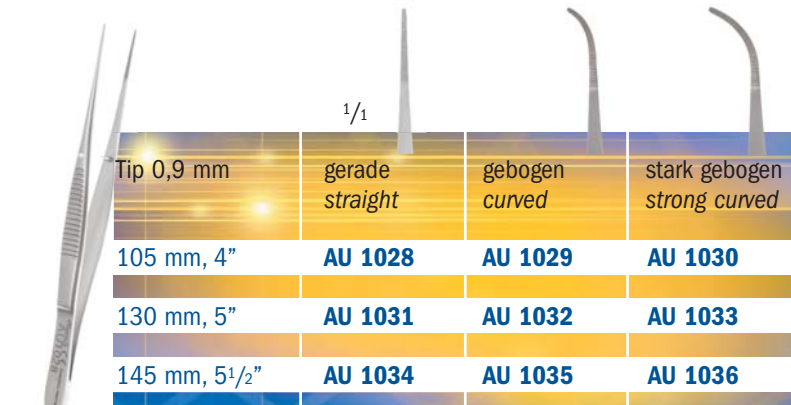

1/2

Tip 0,9 mm	gerade <i>straight</i>	gebogen <i>curved</i>	stark gebogen <i>strong curved</i>
105 mm, 4"	<b>AU 1028</b>	<b>AU 1029</b>	<b>AU 1030</b>
130 mm, 5"	<b>AU 1031</b>	<b>AU 1032</b>	<b>AU 1033</b>
145 mm, 5 <sup>1</sup> / <sub>2</sub> "	<b>AU 1034</b>	<b>AU 1035</b>	<b>AU 1036</b>

**GRAEFE**

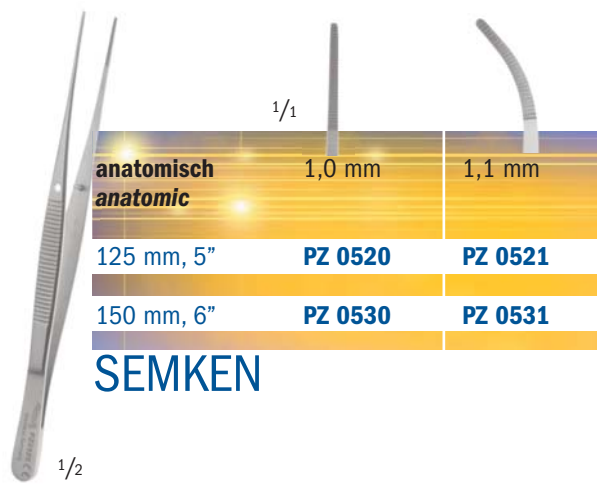

1/2

<b>anatomisch</b> <b>anatomic</b>	1,0 mm	1,1 mm
125 mm, 5"	<b>PZ 0520</b>	<b>PZ 0521</b>
150 mm, 6"	<b>PZ 0530</b>	<b>PZ 0531</b>

**SEMKEN**

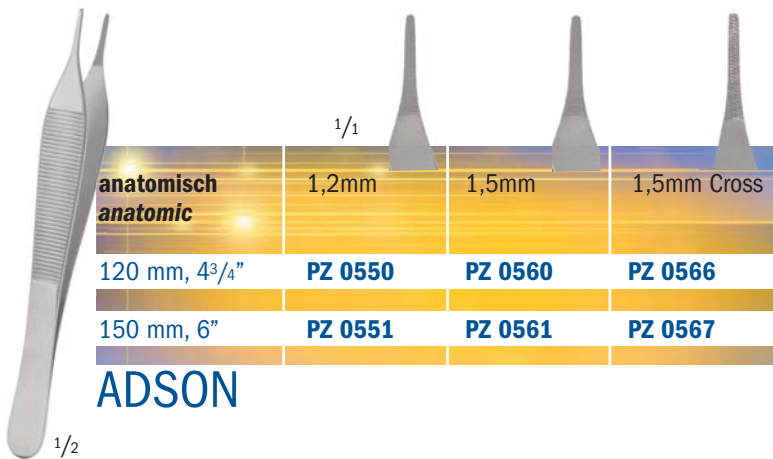

1/2

<b>anatomisch</b> <b>anatomic</b>	1,2mm	1,5mm	1,5mm Cross
120 mm, 4 <sup>3</sup> / <sub>4</sub> "	<b>PZ 0550</b>	<b>PZ 0560</b>	<b>PZ 0566</b>
150 mm, 6"	<b>PZ 0551</b>	<b>PZ 0561</b>	<b>PZ 0567</b>

**ADSON**

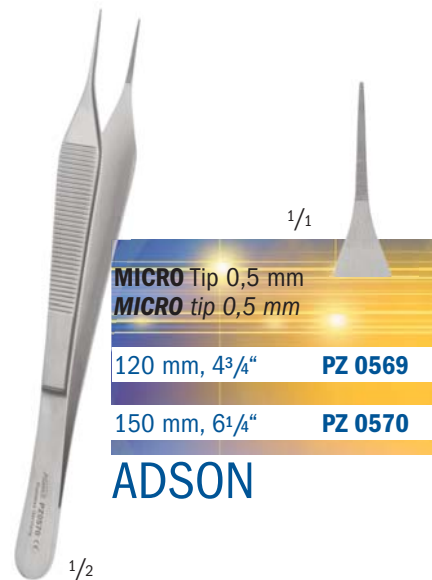

1/2

<b>MICRO</b> Tip 0,5 mm <b>MICRO</b> tip 0,5 mm	
120 mm, 4 <sup>3</sup> / <sub>4</sub> "	<b>PZ 0569</b>
150 mm, 6 <sup>1</sup> / <sub>4</sub> "	<b>PZ 0570</b>

**ADSON**

1/2	fein delicate	TIP TIP	1/1							
			1,0mm	1,1mm	1,6mm	1,8mm	2,2mm	2,3mm	2,4mm	2,5mm
105 mm, 4"	<b>PZ 0201</b>									
115 mm, 4 1/2"	<b>PZ 0202</b>									
130 mm, 5 "	<b>PZ 0203</b>									
145 mm, 5 1/2"	<b>PZ 0204</b>									
160 mm, 6 1/4"	<b>PZ 0205</b>									
180 mm, 7"	<b>PZ 0206</b>									
200 mm, 8"	<b>PZ 0207</b>									
250 mm, 10"	<b>PZ 0208</b>									

**STANDARD**

1/2	mittelbreit medium	TIP TIP	1/1								
			1,7mm	1,9mm	2,2mm	2,2mm	2,4mm	2,6mm	2,8mm	3,0mm	3,0mm
115 mm, 4 1/2"	<b>PZ 0120</b>										
130 mm, 5"	<b>PZ 0130</b>										
145 mm, 5 1/2"	<b>PZ 0140</b>										
150 mm, 6"	<b>PZ 0145</b>										
160 mm, 6 1/4"	<b>PZ 0150</b>										
180 mm, 7"	<b>PZ 0160</b>										
200 mm, 8"	<b>PZ 0170</b>										
230 mm, 9"	<b>PZ 0171</b>										
250 mm, 10"	<b>PZ 0180</b>										
305 mm, 12"	<b>PZ 0190</b>										

**STANDARD**  
GERADE / STRAIGHT



	TIP	1,7mm	1,9mm	2,2mm	2,4mm	2,6mm	2,8mm	3,0mm	3,5mm
<b>mittelbreit</b>	<b>TIP</b>								
<b>medium</b>	<b>TIP</b>								
115 mm, 4½"	<b>PZ 0199</b>								
130 mm, 5"	<b>PZ 0200</b>								
145 mm, 5½"	<b>PZ 0210</b>								
160 mm, 6¼"	<b>PZ 0212</b>								
180 mm, 7"	<b>PZ 0213</b>								
200 mm, 8"	<b>PZ 0214</b>								
250 mm, 10"	<b>PZ 0216</b>								
300 mm, 12"	<b>PZ 0217</b>								

**STANDARD**  
GEBOGEN / CURVED

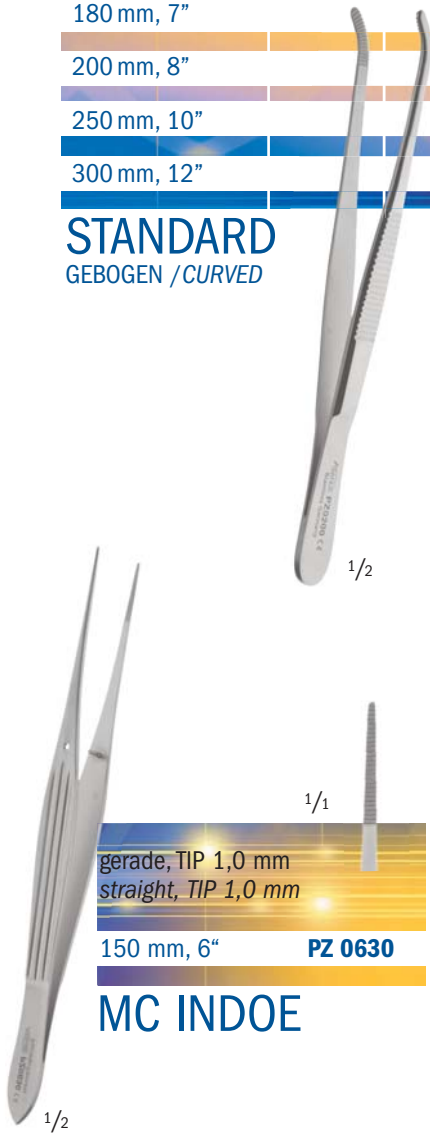



1/2

1/1

1/1

TIP 1,4 mm

gerade  
straight

gebogen  
curved

180 mm, 7"

**PZ 0362**

**PZ 0363**

210 mm, 8 3/4"

**PZ 0364**

**PZ 0365**

250 mm, 10"

**PZ 0366**

**PZ 0367**

300 mm, 12"

**PZ 0368**

**PZ 0369**

## POTTS-SMITH



1/2

1/1

gerade, TIP 2,0 mm  
straight, TIP 2,0 mm

175 mm, 7"

**PZ 0586**

## CUSHING



1/2

1/1

gerade  
straight

175 mm, 7"

**PZ 0584**

## TAYLOR



1/2

1/1

gerade  
straight

250 mm, 10"

**PZ 0660**

## CUSHING



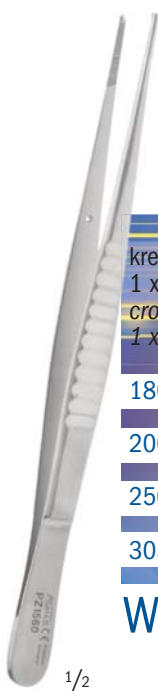

kreuz gerieft 1 x 2 Zähne cross serrated TIP 1 x 2 teeth	TIP	1,7mm	1,9mm	2,5mm	2,6mm
180 mm, 7"		<b>PZ 1560</b>			
200 mm, 8"			<b>PZ 1570</b>		
250 mm, 10"				<b>PZ 1580</b>	
305 mm, 12"					<b>PZ 1600</b>

**WAUGH**



gerieftes Maulplateau 1 x 2 Zähne serrated plateau 1 x 2 teeth					
180 mm, 7"		<b>PZ 1542</b>			
210 mm, 8 1/4"			<b>PZ 1544</b>		
250 mm, 10"				<b>PZ 1546</b>	
300 mm, 12"					<b>PZ 1548</b>
350 mm, 14"					<b>PZ 1554</b>

**POTTS-SMITH**



gerade, TIP 1,4 mm 1 x 2 Zähne straight, TIP 1,4 mm 1 x 2 teeth		
175 mm, 7"		<b>PZ 1674</b>

**TAYLOR**



gerade straight				
150 mm, 6"		<b>PZ 1710</b>		
200 mm, 8"			<b>PZ 1720</b>	
250 mm, 10"				<b>PZ 1725</b>
300 mm, 12"				<b>PZ 1728</b>

**RUSSIAN**



1/2

	1/1	1/1	1/1
1 x 2 Zähne 1 x 2 teeth	gerade straight	gebogen curved	stark gebogen strong curved
105 mm, 4"	<b>AU 1040</b>	<b>AU 1041</b>	<b>AU 1042</b>
130 mm, 5"	<b>AU 1050</b>	<b>AU 1051</b>	<b>AU 1052</b>
145 mm, 5 1/2"	<b>AU 1060</b>	<b>AU 1061</b>	<b>AU 1062</b>

### GRAEFE



1/2

	TIP	1/1	1/1	1/1	1/1
fein 1 x 2 Zähne delicate 1 x 2 teeth		1,15mm	1,2mm	1,25mm	1,3mm
115 mm, 4 1/4"	<b>PZ 1141</b>				
130 mm, 5"		<b>PZ 1142</b>			
145 mm, 5 1/2"			<b>PZ 1143</b>		
160 mm, 6 1/4"				<b>PZ 1144</b>	



1/2

	1/1
gerade, 1 x 2 Zähne straight, 1 x 2 teeth	
125 mm, 5" TIP 0,8 mm	<b>PZ 1540</b>
145 mm, 6" TIP 1,1 mm	<b>PZ 1550</b>

### SEMKEN



1/2

	TIP	1/1	1/1	1/1	1/1	1/1	1/1	1/1	1/1
schmal 1 x 2 Zähne narrow 1 x 2 teeth		1,7mm	1,7mm	1,7mm	1,7mm	1,7mm	1,8mm	2,0mm	2,5mm
115 mm, 4 1/2"	<b>PZ 1130</b>								
130 mm, 5 "		<b>PZ 1140</b>							
145 mm, 5 1/2"			<b>PZ 1150</b>						
160 mm, 6 1/4"				<b>PZ 1160</b>					
180 mm, 7"					<b>PZ 1170</b>				
200 mm, 8"						<b>PZ 1180</b>			
250 mm, 10"							<b>PZ 1190</b>		
300 mm, 12"								<b>PZ 1200</b>	

### STANDARD GERADE / STRAIGHT



	TIP	1,7mm	1,7mm	1,7mm	1,7mm	1,7mm	1,8mm	2,0mm	2,5mm
schmal 1 x 2 Zähne narrow 1 x 2 teeth	TIP								
115 mm, 4 1/2"		<b>PZ 1118</b>							
130 mm, 5 "		<b>PZ 1119</b>							
145 mm, 5 1/2"		<b>PZ 1120</b>							
160 mm, 6 1/4"		<b>PZ 1121</b>							
180 mm, 7"		<b>PZ 1122</b>							
200 mm, 8"		<b>PZ 1123</b>							
250 mm, 10"		<b>PZ 1124</b>							
300 mm, 12"		<b>PZ 1125</b>							

**STANDARD** GEBOGEN / CURVED



	TIP	1,2mm	1,5mm	1,5mm
1 x 2 Zähne 1 x 2 teeth	TIP			
120 mm, 4 3/4"		<b>PZ 1051</b>	<b>PZ 1055</b>	<b>PZ 1062</b>
150 mm, 6"		<b>PZ 1052</b>	<b>PZ 1056-1</b>	

**ADSON**



1 x 2 Zähne 1 x 2 teeth	
155 mm, 6 1/4"	<b>PZ 1460</b>

**GILLIES**



1 x 2 Zähne, TIP 1,8mm 1 x 2 teeth, TIP 1,8mm	
150 mm, 6"	<b>PZ 1470</b>

**MC INDOE**

Diese Power TC Pinzetten werden hauptsächlich für Nahtarbeiten verwendet, mit sehr langer Lebensdauer.  
These Power TC forceps are mainly used for suture work, which enables a long life duration.

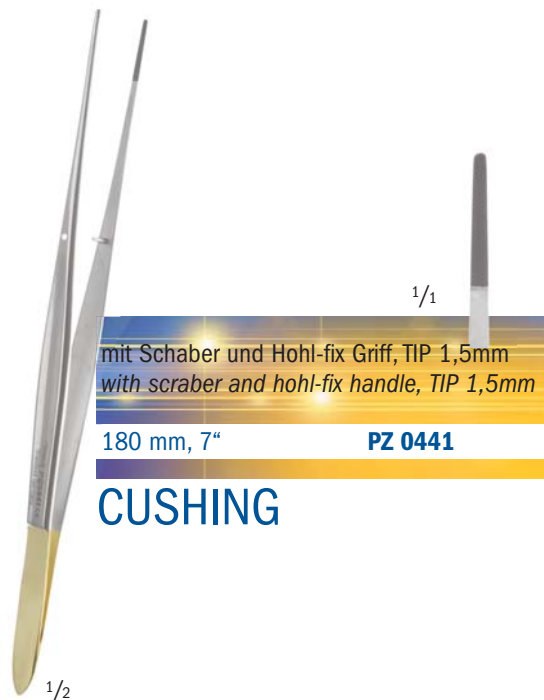
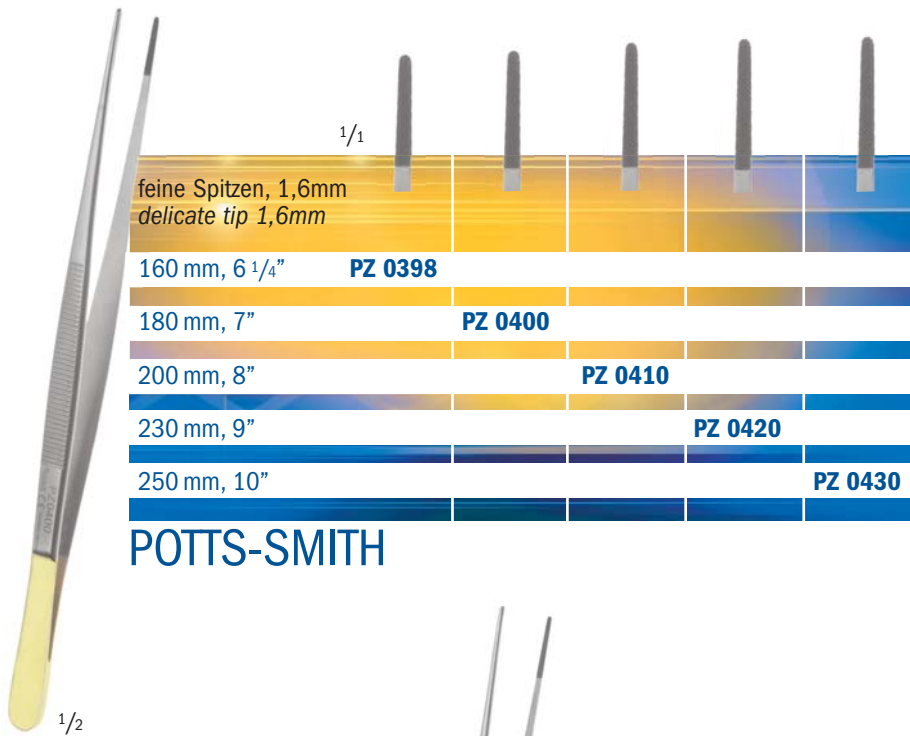
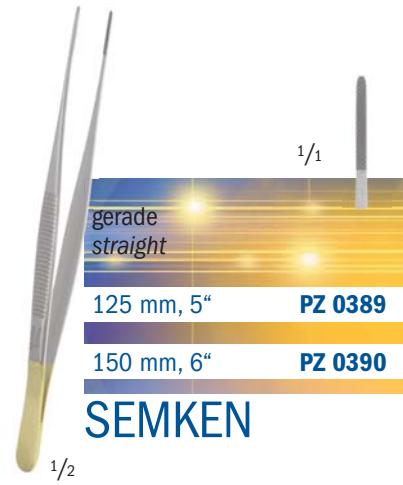
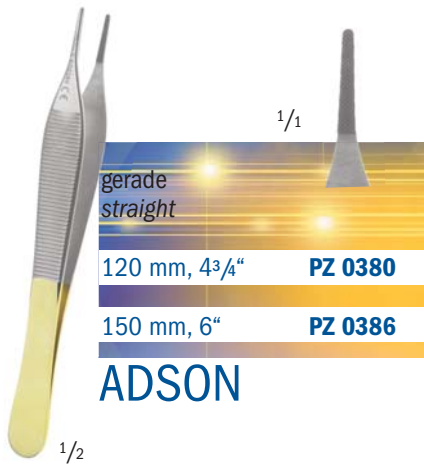

Diese Power TC Pinzetten haben eine sehr hohe Abriebfestigkeit und entsprechend eine lange Lebensdauer.  
These Power TC forceps are very hard at the tips with a long life duration.

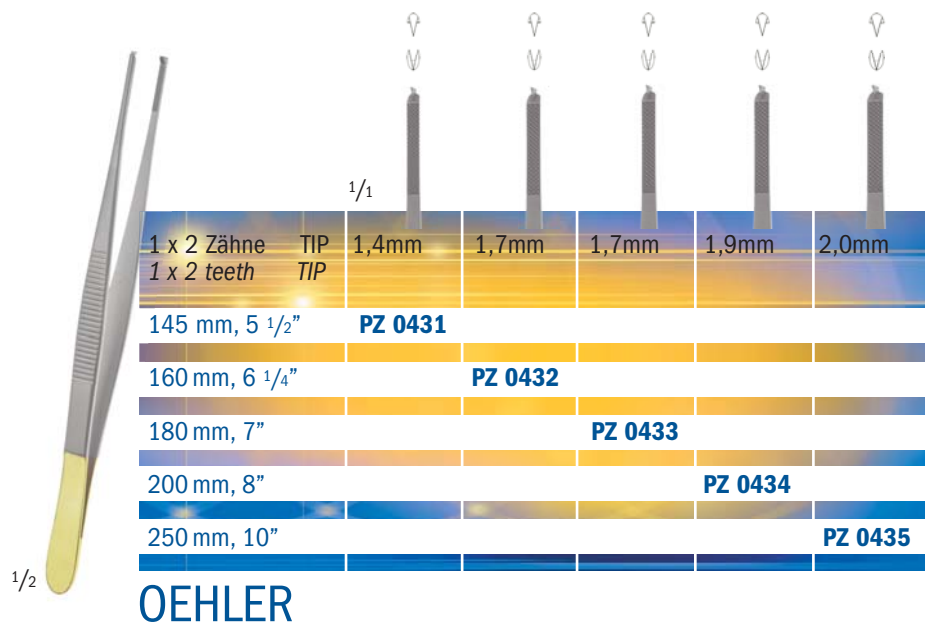
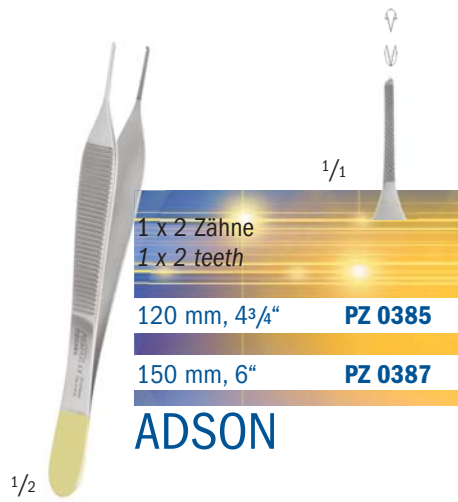



	1/1					
grade straight	1,0 mm	1,5 mm	2,0 mm	2,4 mm	2,8 mm	3,5 mm
155 mm, 6 <sup>1</sup> / <sub>4</sub> "	<b>GF 0831</b>	<b>GF 0830</b>		<b>GF 0792</b>		
160 mm, 6 <sup>1</sup> / <sub>4</sub> "			<b>GF 0740</b>		<b>GF 0850</b>	<b>GF 0882</b>
200 mm, 8"	<b>GF 0829</b>	<b>GF 0840</b>	<b>GF 0760</b>	<b>GF 0794</b>	<b>GF 0860</b>	<b>GF 0884</b>
240 mm, 9 <sup>1</sup> / <sub>2</sub> "		<b>GF 0844</b>	<b>GF 0780</b>	<b>GF 0796</b>	<b>GF 0870</b>	<b>GF 0886</b>
305 mm, 12"		<b>GF 0848</b>	<b>GF 0790</b>	<b>GF 0798</b>	<b>GF 0880</b>	<b>GF 0888</b>
350 mm, 14"			<b>GF 0889</b>	<b>GF 0899</b>		<b>GF 0891</b>

## DE BAKEY

	1/1			
gerade straight	2,8 mm	3,5 mm	1,5 mm	2,0 mm
155 mm, 6 <sup>1</sup> / <sub>4</sub> "	<b>GF 0872</b>	<b>GF 0799</b>	<b>GF 0851</b>	<b>GF 0750</b>
200 mm, 8"	<b>GF 0874</b>	<b>GF 0800</b>	<b>GF 0852</b>	<b>GF 0770</b>
240 mm, 9 <sup>1</sup> / <sub>2</sub> "	<b>GF 0876</b>	<b>GF 0810</b>	<b>GF 0853</b>	<b>GF 0776</b>
300 mm, 12"	<b>GF 0878</b>	<b>GF 0821</b>	<b>GF 0854</b>	<b>GF 0778</b>

## DE BAKEY

	1/1	
gerade straight	2,0 mm	2,7 mm
200 mm, 8"	<b>GF 0757</b>	<b>GF 0759</b>

## COOLEY

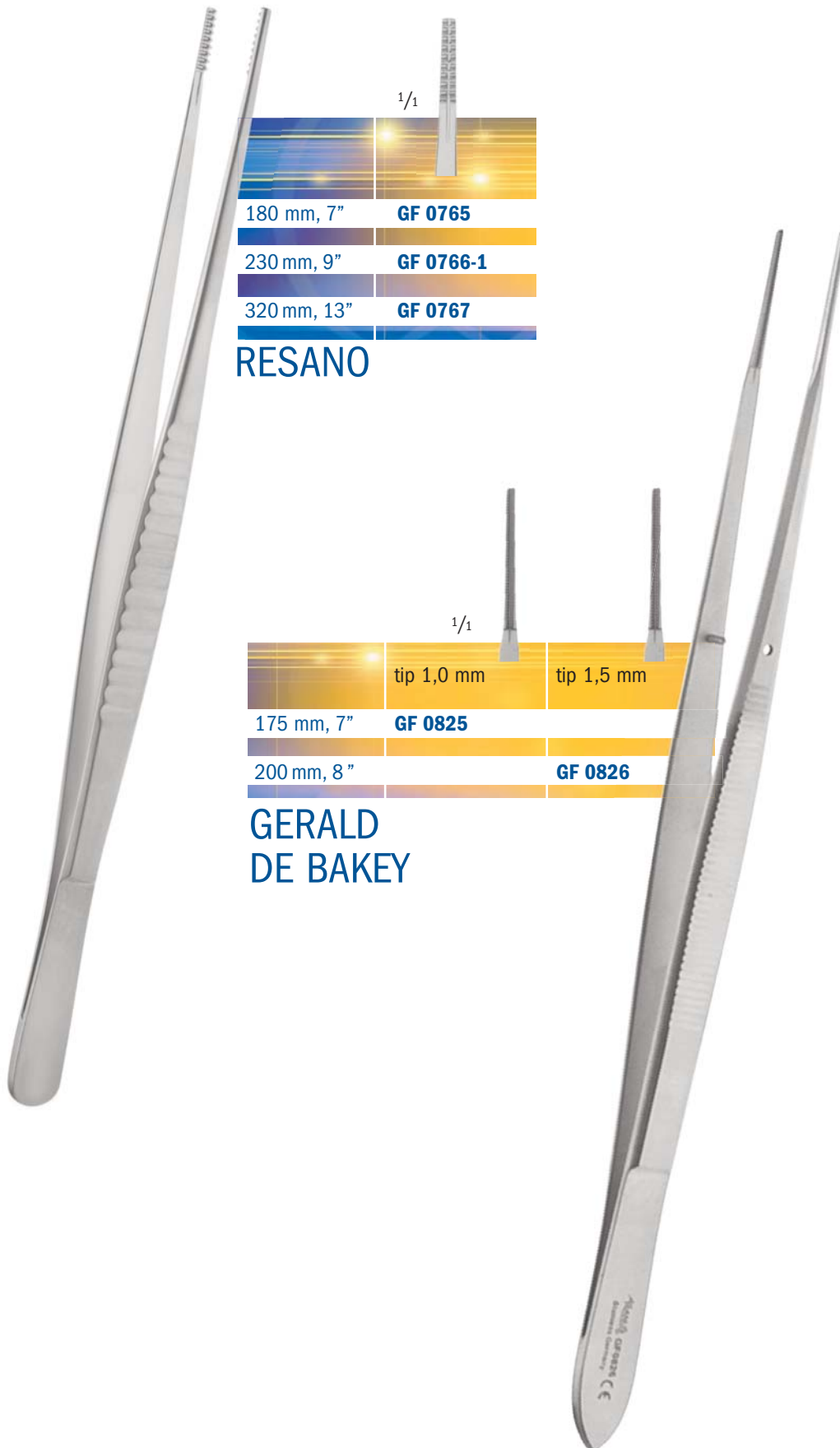

	1/1
180 mm, 7"	<b>GF 0765</b>
230 mm, 9"	<b>GF 0766-1</b>
320 mm, 13"	<b>GF 0767</b>
<b>RESANO</b>	

	1/1	
	tip 1,0 mm	tip 1,5 mm
175 mm, 7"	<b>GF 0825</b>	
200 mm, 8"		<b>GF 0826</b>
<b>GERALD DE BAKEY</b>		

**Bipolares Koagulations-Pinzettensystem mit auswechselbaren Spitzen**

*Bipolar coagulation forceps system with exchangeable tips*

**PROBLEMATIK** beim bipolaren Koagulieren mit herkömmlichen Bipolarpinzetten

**PREVIOUS SITUATION** with bipolar coagulation forceps and its problems

Pinzettenspitzen werden durch das Koagulieren stark mit Nekrosen verunreinigt. Dadurch folgt:

- Koagulieren wird erheblich erschwert, zeitlich verzögert und die Koagulationsergebnisse sind zum Teil unbefriedigend
- Hygienische Risiken werden vergrößert durch Verschleppung von Nekrosrückständen an den Pinzettenspitzen
- Das Reinigen der herkömmlichen Pinzettenspitzen von den Nekrosrückständen kann meist nur noch durch Metallbürsten erfolgen. Hierbei wird die Isolationsschicht der Pinzetenbranchen stark beschädigt
- Schadhafte Isolationsschichten können zu ungewollten Koagulationseffekten am Patienten führen
- Hohe Instandhaltungskosten durch Isolationsreparaturen
- Das Reinigen und Aufbereiten der mit Nekrosepartikeln verschmutzten Koagulationspinzetten erfordert einen erheblichen Zeit und somit ein hoher Personaleinsatz.
- Für jede erforderliche Pinzettenspitzenbreite ist eine preisintensive Koagulationspinzette erforderlich, was die Investitionen und die Siebgewichte erhöht.

**Bipolar tips are often been strongly poluted by necroses due to coagulation. The results are**

- *Coagulation procedure becomes more difficult, takes more time and the coagulation results are often not satisfied at all*
- *Hygienic risks increase due to transmission of necrose particals form one to the other patient*
- *Cleaning of the tips is mostly to been done by metall-brushes. This procedure destroys very often the isolation at near by the coagulation tips*
- *Damaged isolation field may allow uncontrolled coagulations at patients- high risk*
- *High service costs for new isolation of old forceps*
- *High time consume for cleaning the bipolar forceps and remove necroses polution*
- *For each different tip width is a complete new bipolar forcep modell necessary. This increase investment and the weight of the instrument set including the maintainance and sterilization expense.*

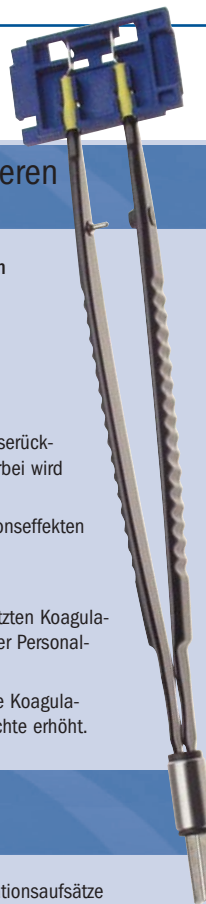

**VORTEILE ASANUS-BiTIP Koagulations-System**

**NEW ASANUS BiTIP Coagulation System**

- Nur ein Pinzettenträger erforderlich und drei verschiedene Koagulationsaufsätze intraoperativ wählbar und auswechselbar
- Keine Reinigung mehr erforderlich
- Optimale Koagulationsmöglichkeit durch permanent saubere Pinzettenspitzen
- Optimale Führung der Spitzen durch Führungspin im vorderen Branchenbereich
- Pinzettenträger wird optimal geschont, durch Isolationsüberzug der Pinzettenspitzen
- Mehrfach sterilisierbar und einsetzbar
- Hohe Wirtschaftlichkeit durch Entfall der Reinigungskosten und sehr hoher Standzeit der Pinzettenträger
- Pinzettenträger sind in gerader, gewinkelter und bajonettförmiger Form als ein kompaktes System für alle Spitzenaufsätze erhältlich
- Magazine sind farblich nach Pinzetenbreiten getrennt
- Das BiTIPMagazin-System ist auch in Kombination von verschiedenen Pinzettenspitzenbreiten zusammensteckbar und so als ein ganzheitliches System für jeden Einsatz individuell einsetzbar.
- Sichere doppelte Halteschutzfunktion zwischen Pinzettenträger und den Pinzetenaufsätzen garantiert eine sichere Handhabung beim Koagulieren

- *One basic forceps unit is intraoperative usable with different available tips*
- *No cleaning and maintainance of the tips necessary*
- *Optimal coagulation results, due to permanent clean tips*
- *Optimal guide between the two forcep shanks with ASANUS safety pin*
- *Basic forceps are been secured throug isolation cover of the tips*
- *Tips are multi usable and sterilizable*
- *High economical aspects due to long durability of the basic forceps and no more cleaning*
- *Basic forceps are usable with all different tip measurements. Lesser forceps are been necessary with a wider tip possibility*
- *BiTIP magazins are cloured from shiny (delicate) to dark (wide) to recognize easily the type of the tip*
- *BiTIP magazins may be combinated and sticked together with different tip measurements*
- *Safety double connection system assures optimal fixation between the basic forceps and the exchangeable tips*

Magazine (Pkg = 10 Paar)  
BiTIP box = 10 pair

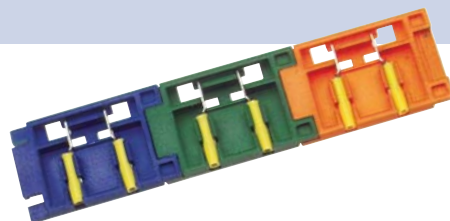

Breiten	Farben	
Width of tip	colour	
0,1 mm	Weiß / white	<b>KG 0147</b>
0,5 mm	Orange / orange	<b>KG 0150</b>
1,0 mm	Grün / green	<b>KG 0152</b>
2,0 mm	Blau / blue	<b>KG 0156</b>



**KG 0161**  
BiTIP MAGAZINLADER und Entferner, sterilisierbar für die BiTIP Magazine und Pinzettenträger  
BiTIP CHARGER and REMOVER, sterilizable 134° for BiTIP magazines and forceps



BiTIP Pinzetten  
BiTIP Forceps

KG

10 Paar jeweils in Sterilisierbox  
10 pairs with sterilisation and storage box

0,1mm weiß/ white  
0,5mm orange/ orange  
1,0mm grün/ green  
2,0mm blau/ blue

gewinkelt  
angled  
**KG 0148**  
**KG 0151**  
**KG 0153**  
**KG 0157**



gewinkelt, steril  
angled, sterile  
**KG 0148S**  
**KG 0151S**  
**KG 0153S**  
**KG 0157S**

**KG 0159**  
50 mm lang  
biegsam, steril  
glatte Maulfläche  
verpackt 1 Paar/  
50 mm long  
malleable, sterile  
smooth surface,  
packed 1 pair



**KG 0158**  
50 mm lang  
biegsam, steril  
geriefte Maulfläche  
verpackt 1 Paar/  
50 mm long  
malleable, sterile  
serrated surface  
packed 1 pair

gerade straight Längen length			bajonett gebogen bajonett shaped Längen total length	Arbeitslänge working length	
	schmal small	breit wide			
110 mm	<b>KG 0120</b>	<b>KG 0120B</b>			
160 mm	<b>KG 0122</b>	<b>KG 0122B</b>	160 mm	35 mm	<b>KG 0140</b>
195 mm	<b>KG 0124</b>	<b>KG 0124B</b>	195 mm	75 mm	<b>KG 0142</b>
220 mm	<b>KG 0126</b>	<b>KB 0126B</b>	215 mm	95 mm	<b>KG 0143</b>
250 mm	<b>KG 0128</b>	<b>KG 0128B</b>	235 mm	115 mm	<b>KG 0144</b>
300 mm	<b>KG 0130</b>	<b>KG 0130B</b>	255 mm	135 mm	<b>KG 0145</b>

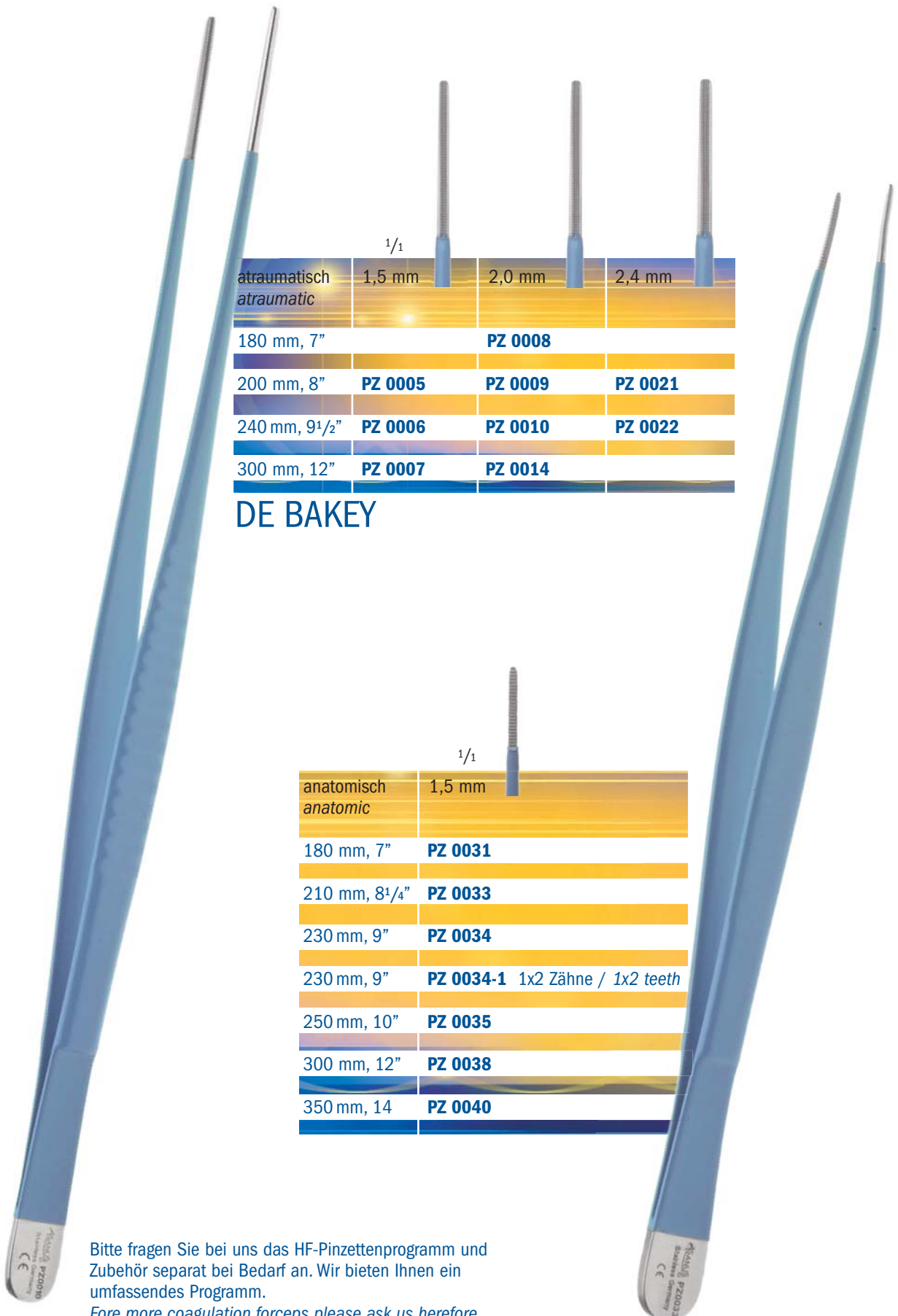

	1/1		
atraumatisch atraumatic	1,5 mm	2,0 mm	2,4 mm
180 mm, 7"	<b>PZ 0008</b>		
200 mm, 8"	<b>PZ 0005</b>	<b>PZ 0009</b>	<b>PZ 0021</b>
240 mm, 9 1/2"	<b>PZ 0006</b>	<b>PZ 0010</b>	<b>PZ 0022</b>
300 mm, 12"	<b>PZ 0007</b>	<b>PZ 0014</b>	

## DE BAKEY

	1/1	
anatomisch anatomic	1,5 mm	
180 mm, 7"	<b>PZ 0031</b>	
210 mm, 8 1/4"	<b>PZ 0033</b>	
230 mm, 9"	<b>PZ 0034</b>	
230 mm, 9"	<b>PZ 0034-1</b>	1x2 Zähne / 1x2 teeth
250 mm, 10"	<b>PZ 0035</b>	
300 mm, 12"	<b>PZ 0038</b>	
350 mm, 14"	<b>PZ 0040</b>	

Bitte fragen Sie bei uns das HF-Pinzettenprogramm und Zubehör separat bei Bedarf an. Wir bieten Ihnen ein umfassendes Programm.

For more coagulation forceps please ask us herefore.  
We can provide you a wide regal of bipolar forceps too.

SCHEREN  
SCISSORS



Blattlänge / blade length								
10 mm								
<b>Mikro Schere, mit Flachgriff</b> <b>micro scissors with flat handle</b>	gebogen curved	25°	45°	60°	90°	125° Cirkumflex	125° eng narrow Cirkumflex	180° for off pump surgery
standard line 165 mm, 6 1/2"		<b>SC 0031</b>	<b>SC 0032</b>	<b>SC 0033</b>	<b>SC 0034</b>	<b>SC 0035</b>	<b>SC 0036</b>	<b>SC 0037</b>
long line 200 mm, 8"			<b>SC 0173</b>	<b>SC 0174</b>	<b>SC 0175</b>	<b>SC 0176</b>	<b>SC 0177-1</b>	<b>SC 0177</b>
	<b>Kugelschutz safety bead tip</b>	mit Kugelschutz für untere Gefäßwand with safety ball tip for downer vascular wall						
165 mm, 6 1/2"		<b>SC 0134</b>	<b>SC 0135</b>	<b>SC 0136</b>	<b>SC 0137</b>	<b>SC 0138</b>	<b>SC 0139</b>	<b>SC 0141</b>
200 mm, 8"		<b>SC 0214</b>	<b>SC 0215</b>	<b>SC 0216</b>	<b>SC 0217</b>	<b>SC 0218</b>	<b>SC 0219</b>	<b>SC 0211</b>







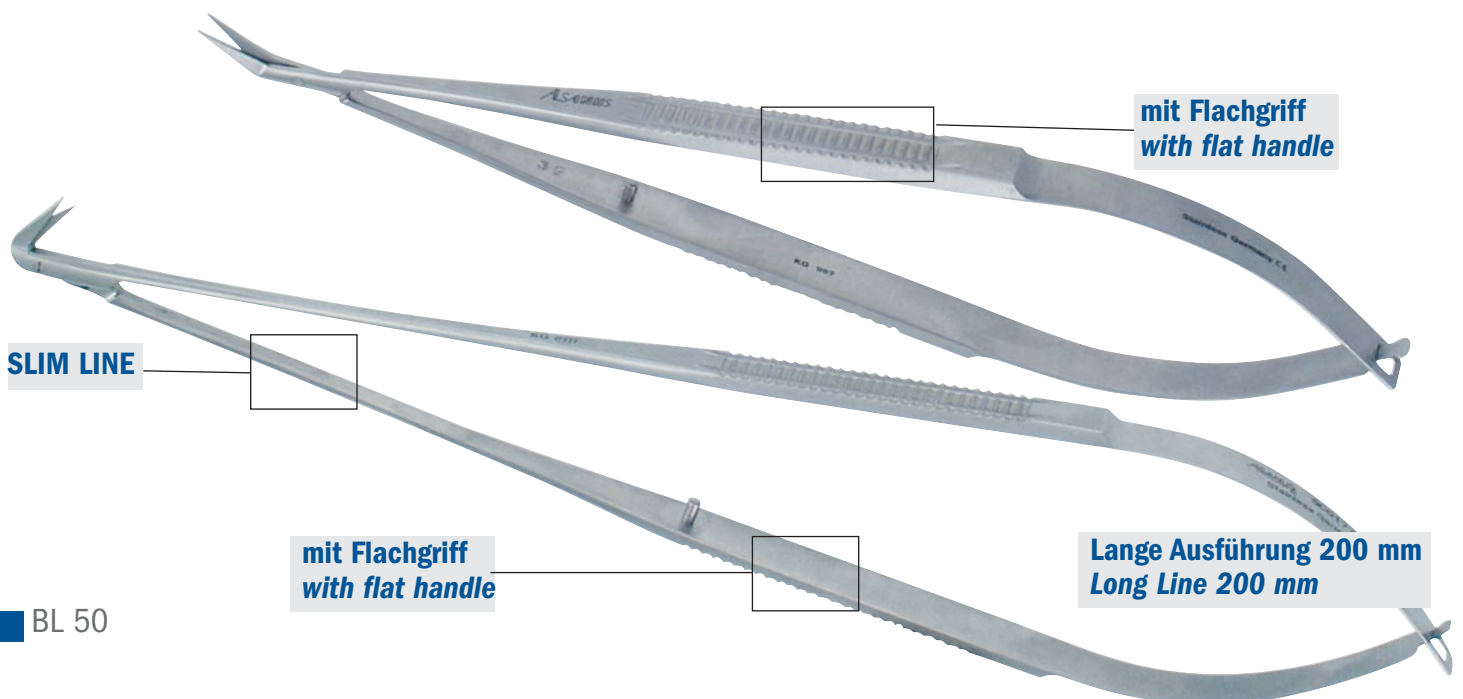

## MICRO SWAN

Blattlänge / blade length									
7 mm									
<b>Mikro Schere, mit Flachgriff</b> <b>micro scissors with flat handle</b>	gerade straight	gebogen curved	25°	45°	60°	90°	125°	125° eng narrow	gerade straight DELICATE
standard line 165 mm, 6 1/2"		<b>SC 0004</b>	<b>SC 0005</b>	<b>SC 0006</b>	<b>SC 0007</b>	<b>SC 0008</b>	<b>SC 0009</b>	<b>SC 0010</b>	<b>SC 0089</b>
long line 200 mm, 8"			<b>SC 0103</b>	<b>SC 0104</b>	<b>SC 0105</b>	<b>SC 0106</b>	<b>SC 0107</b>	<b>SC 0101</b>	







## SLIM LINE SWAN



BL 50

								
<b>Mikro Schere, mit Rundgriff</b> <b>micro scissors</b> <b>with round handle</b> <b>for off pump</b>	gebogen	25° <i>curved</i>	45°	60°	90°	125° Cirkumflex	125° eng narrow Cirkumflex	180° <i>for off</i>  <i>surgery</i>
kurz short 110 mm, 4 1/4"	<b>SC 0091</b>	<b>SC 0092</b>	<b>SC 0093</b>	<b>SC 0094</b>	<b>SC 0095</b>	<b>SC 0096</b>		
standard line 165 mm, 6 1/2"	<b>SC 0041</b>	<b>SC 0042</b>	<b>SC 0043</b>	<b>SC 0044</b>	<b>SC 0045</b>	<b>SC 0046</b>	<b>SC 0048</b>	<b>SC 0047</b>
long line 200 mm, 8"		<b>SC 0198</b>	<b>SC 0199</b>	<b>SC 0203</b>	<b>SC 0204</b>	<b>SC 0205</b>		
<b>Kugelschutz safety bead tip</b>	mit Kugelschutz für untere Gefäßwand <i>with safety ball tip for downer vascular wall</i>							
 165 mm, 6 1/2"		<b>SC 0144</b>	<b>SC 0145</b>	<b>SC 0146</b>	<b>SC 0147</b>	<b>SC 0148</b>	<b>SC 0149</b>	<b>SC 0151</b>
200 mm, 8"		<b>SC 0224</b>	<b>SC 0225</b>	<b>SC 0226</b>	<b>SC 0227</b>	<b>SC 0228</b>	<b>SC 0229</b>	<b>SC 0221</b>





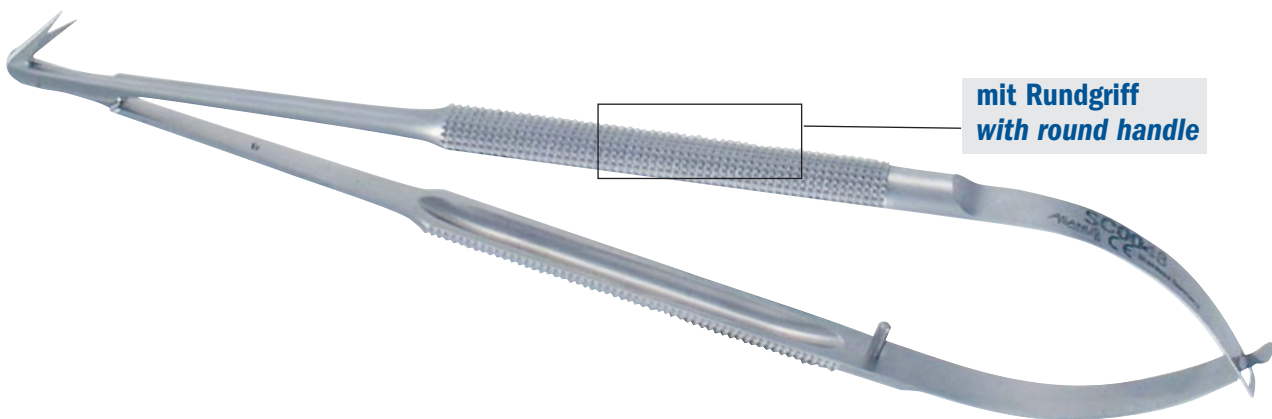

## MICRO SWAN

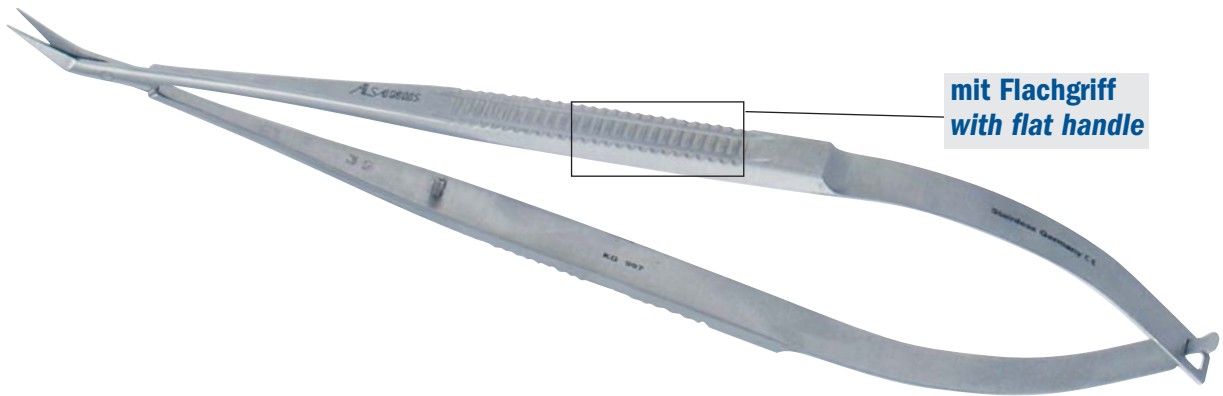
						
<b>Mikro Schere, mit Rundgriff</b> <b>micro scissors,</b> <b>with round handle</b>	gebogen <i>curved</i>	25°	45°	60°	90°	125° Cirkumflex
standard line 165 mm, 6 1/2"	<b>SC 0153</b>	<b>SC 0154</b>	<b>SC 0155</b>	<b>SC 0156</b>	<b>SC 0157</b>	<b>SC 0158</b>
extra long 250 mm, 10"				<b>SC 0156-1</b>		<b>SC 0158-1</b>





## SLIM LINE SWAN



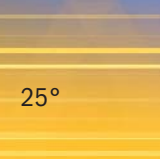
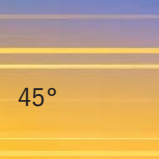
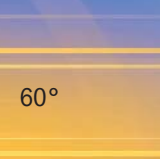
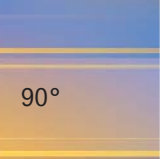

							
<b>Mikro Schere, mit Flachgriff micro scissors with flat handle</b>	gerade straight	gebogen curved	25°	45°	60°	90°	125°
Blattlänge / blade length 14 mm							
standard line 165 mm, 6 1/2"	<b>SC 0070</b>	<b>SC 0071</b>	<b>SC 0072</b>	<b>SC 0073</b>	<b>SC 0074</b>	<b>SC 0075</b>	<b>SC 0076</b>
long line 180 mm, 7"	<b>SC 0080</b>	<b>SC 0081</b>					

**STANDARD**

							
<b>Mikro Schere, mit Rundgriff micro scissors with round handle</b>	gerade straight	gebogen curved	25°	45°	60°	90°	125°
long line 180 mm, 7"			<b>SC 0092-1</b>	<b>SC 0093-1</b>	<b>SC 0094-1</b>	<b>SC 0095-1</b>	<b>SC 0096-1</b>

**STANDARD**

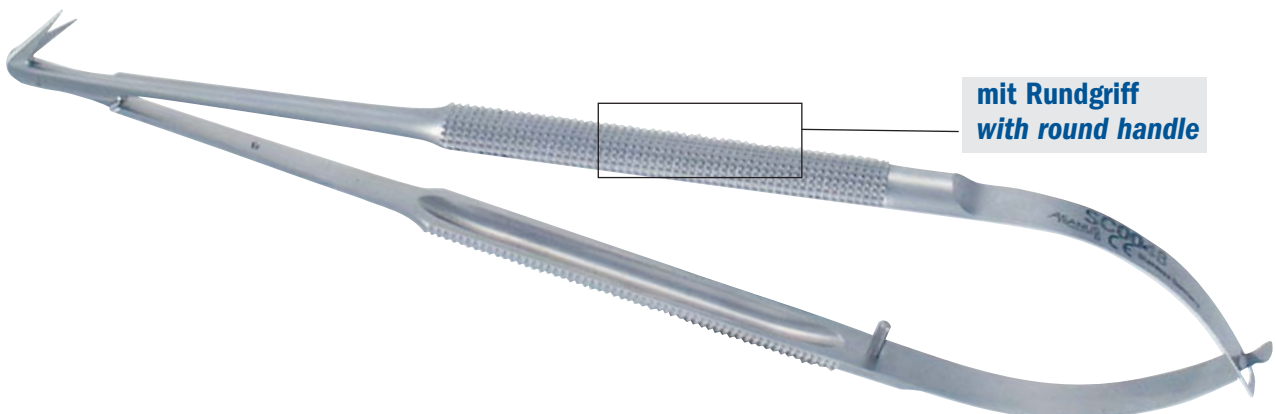

<b>Mikro Schere, mit Flachgriff</b> <b>micro scissors</b> <b>with flat handle</b>	gebogen <i>curved</i>	25°	45°	60°	90°	125° Cirkumflex	125° eng narrow Cirkumflex	180° for off pump surgery
standard line 165 mm, 6 1/2"	SC 0031T	SC 0032T	SC 0033T	SC 0034T	SC 0035T	SC 0036T	SC 0038T	SC 0037T
long line 200 mm, 8"		SC 0173T	SC 0174T	SC 0175T	SC 0176T		SC 0177T	SC 0178T

<b>Kugelschutz safety bead tip</b>	mit Kugelschutz für untere Gefäßwand <i>with safety ball tip for downer vascular wall</i>							
	165 mm, 6 1/2"	SC 0134T	SC 0135T	SC 0136T	SC 0137T	SC 0138T	SC 0139T	SC 0141T
	200 mm, 8"	SC 0214T	SC 0215T	SC 0216T	SC 0217T	SC 0218T	SC 0219T	SC 0211T

MICRO SWAN

<b>Mikro Schere, mit Flachgriff</b> <b>micro scissors</b> <b>with flat handle</b>	gebogen <i>curved</i>	25°	45°	60°	90°	125°	125° eng narrow	gerade straight DELICATE
standard line 165 mm, 6 1/2"	SC 0005T	SC 0006T	SC 0007T	SC 0008T	SC 0009T	SC 0010T		SC 0089T
long line 200 mm, 8"		SC 0103T	SC 0104T	SC 0105T	SC 0106T	SC 0107T	SC 0101T	

SLIM LINE SWAN

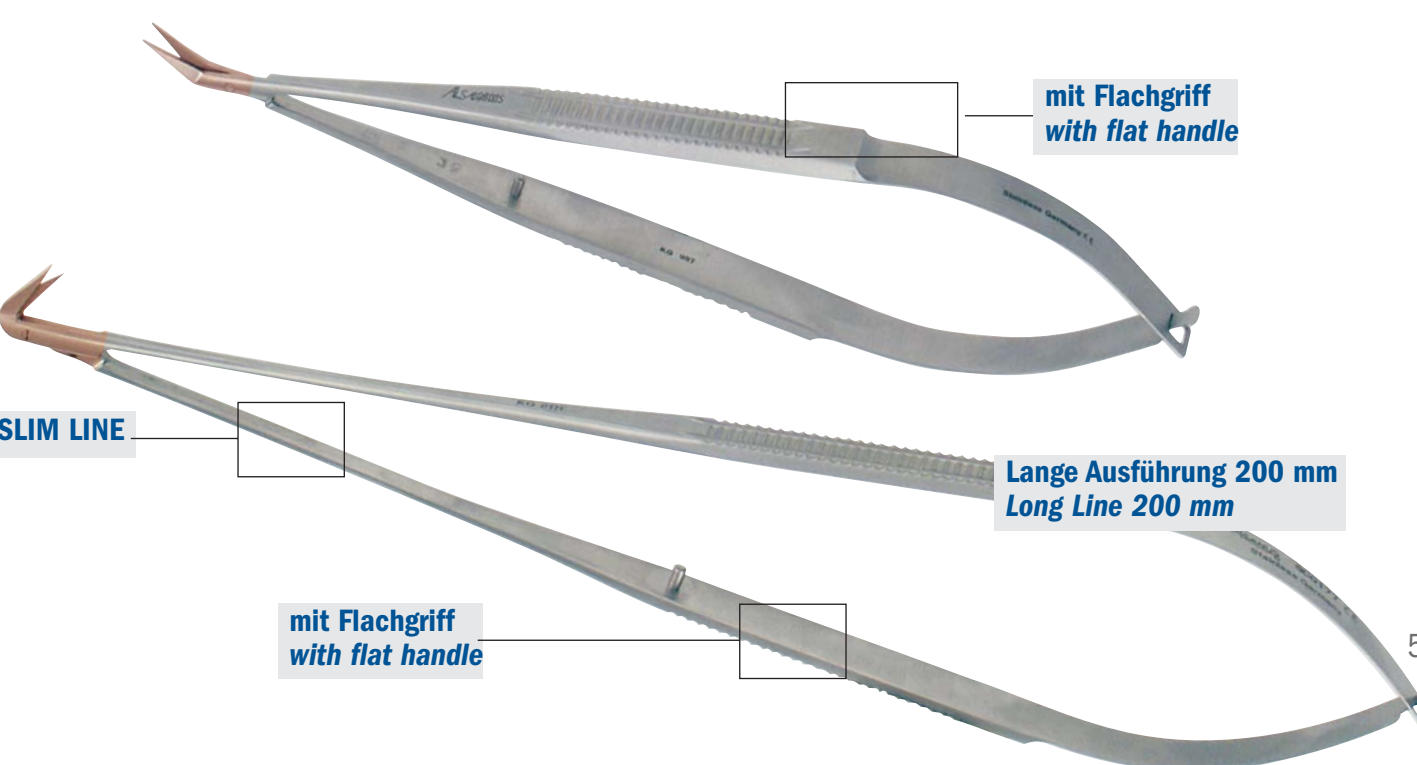

<b>Mikro Schere, mit Rundgriff</b> <b>micro scissors</b> <b>with round handle</b> <b>for off pump</b>	gebogen	25° <i>curved</i>	45°	60°	90°	125° Cirkumflex	125° eng narrow Cirkumflex	180° <i>for off pump surgery</i>
standard line 165 mm, 6 1/2"	SC 0041T	SC 0042T	SC 0043T	SC 0044T	SC 0045T	SC 0046T	SC 0048T	SC 0047T
long line 200 mm, 8"		SC 0198T	SC 0199T	SC 0203T	SC 0204T		SC 0205T	SC 0221T
<b>Kugelschutz safety bead tip</b>	mit Kugelschutz für untere Gefäßwand <i>with safety ball tip for downer vascular wall</i>							
165 mm, 6 1/2"		SC 0144T	SC 0145T	SC 0146T	SC 0147T	SC 0148T	SC 0149T	SC 0151T
200 mm, 8"		SC 0224T	SC 0225T	SC 0226T	SC 0227T	SC 0228T	SC 0229T	

## MICRO SWAN





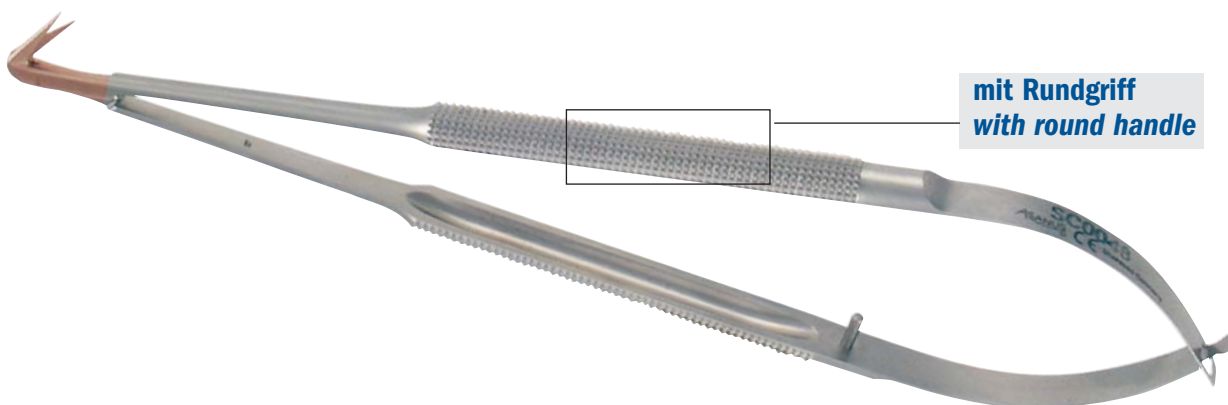

<b>Mikro Schere, mit Rundgriff</b> <b>micro scissors,</b> <b>with round handle</b>	gebogen <i>curved</i>	25°	45°	60°	90°	125° Cirkumflex
standard line 165 mm, 6 1/2"	SC 0153T	SC 0154T	SC 0155T	SC 0156T	SC 0157T	SC 0158T
extra long 250 mm, 10"				SC 0156-1T		

## SLIM LINE SWAN









mit Rundgriff  
with round handle

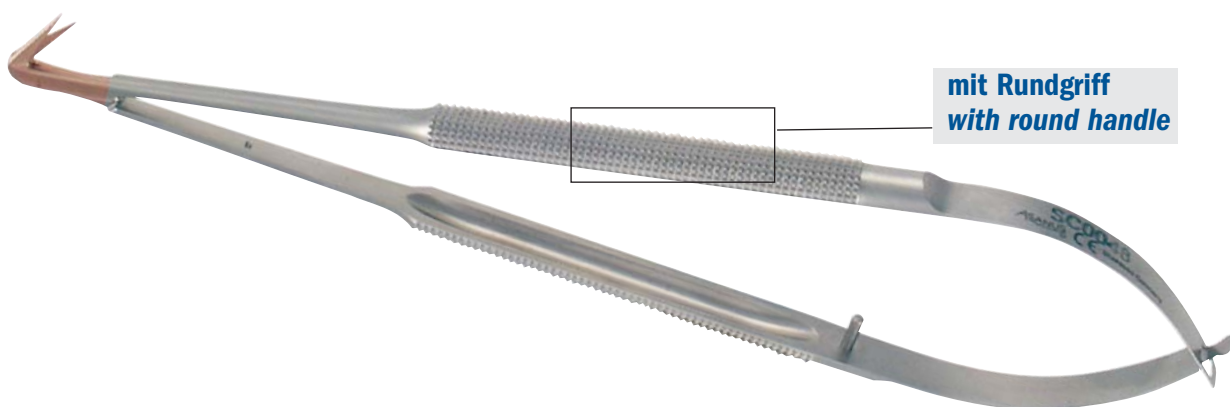

						
<b>Mikro Schere, mit Rundgriff micro scissors with round handle</b>	gebogen curved	25°	45°	60°	90°	125°
Blattlänge / blade length 14 mm						
110 mm, 4 1/4"	<b>SC 0091T</b>	<b>SC 0092T</b>	<b>SC 0093T</b>	<b>SC 0094T</b>	<b>SC 0095T</b>	<b>SC 0096T</b>
180 mm, 7"	<b>SC 0091-1T</b>	<b>SC 0092-1T</b>	<b>SC 0093-1T</b>	<b>SC 0094-1T</b>	<b>SC 0095-1T</b>	<b>SC 0096-1T</b>

## STANDARD



					
<b>Mikro Scheren, Bajonett micro scissors, bajonett shape</b>	125° Cirkumflex	125° Cirkumflex	45° gewinkelt 45° angled	nach oben gebogen Tenotomie Blätter curved upwards tenotomy tips	gerade Tenotomie Blätter straight tenotomy tips
205 mm, 8"	<b>MN 0277 N</b>	<b>MN 0277</b>			
215 mm, 9"			<b>MN 0269</b>	<b>MN 0279</b>	<b>MN 0278</b>

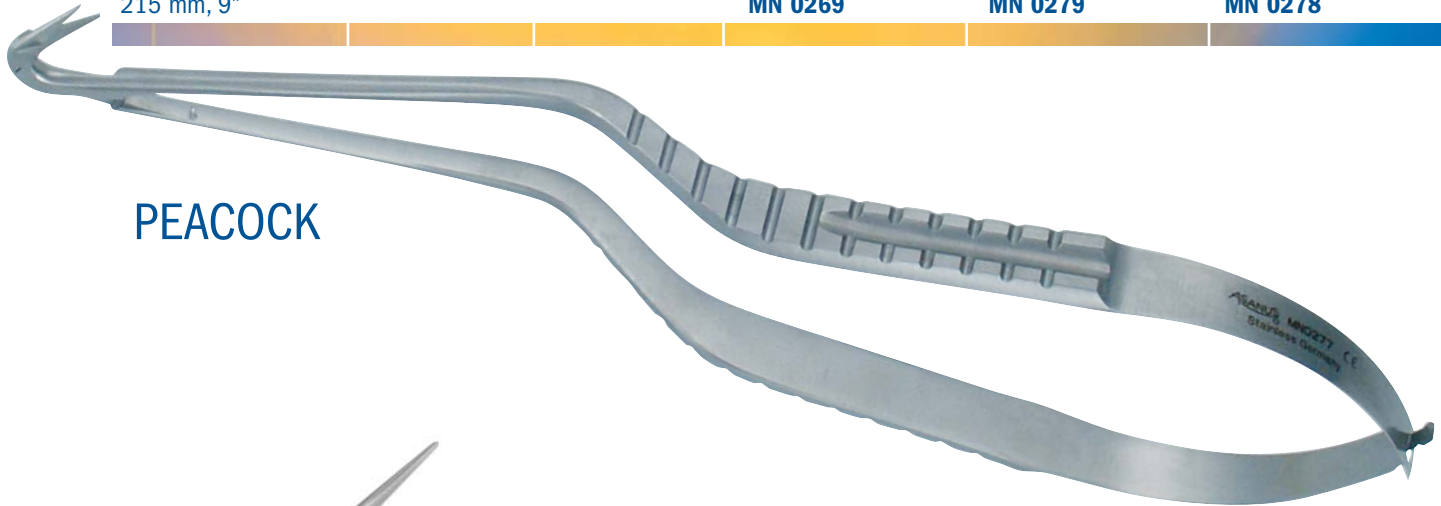

**PEACOCK**

	spitz/spitz aufgewinkelt sharp/sharp up-angled
180 mm, 7 "	<b>SC 0022</b>



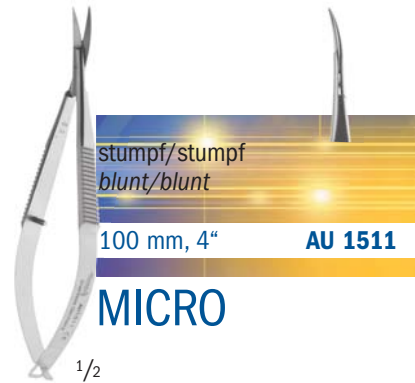
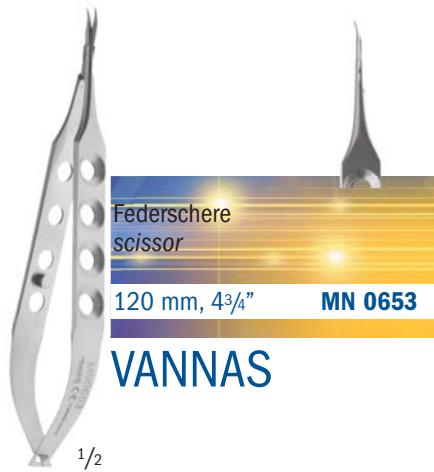

									<b>Delikate Spitze</b> <i>Delicate tip</i>
<b>gebogen</b> <i>curved</i>	Kilner-Blatt stumpf <i>blunt</i> Micro Delikate	Tenotomie Blatt stumpf <i>tenotomy tips,</i> <i>blunt</i>	Ragnell-Blatt spitz <i>Ragnell tips,</i> <i>sharp</i>	feines rundes Blatt spitz <i>fine round tips,</i> <i>sharp</i>					
145 mm, 5 <sup>3</sup> / <sub>4</sub> "		<b>SC 1126</b>							
180 mm, 7"	<b>SC 1135</b>	<b>SC 1136</b>	<b>SC 1137</b>	<b>SC 1138</b>					

**GLASGOW**

für die Präparation der  
 Mammaria Arterie

*for dissection and preparation of*  
 Mammaria Arteria

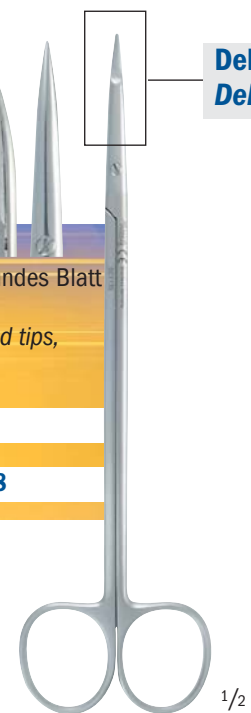

		25°	45°	60°	90°	125°
130 mm, 5"	TITANIT®	<b>SC 8821</b>	<b>SC 8831</b>	<b>SC 8841</b>	<b>SC 8851</b>	<b>SC 8861</b>
180 mm, 7"	TITANIT®	<b>SC 8822</b>	<b>SC 8832</b>	<b>SC 8842</b>	<b>SC 8852</b>	<b>SC 8862</b>
130 mm, 5"	Stahl Steel	<b>SC 3821</b>	<b>SC 3831</b>	<b>SC 3841</b>	<b>SC 3851</b>	<b>SC 3861</b>
170 mm, 6 3/4"	Stahl Steel		<b>SC 1841</b>	<b>SC 1842</b>	<b>SC 1843</b>	

**MICRO SLIM LINE POTTS**

TITANIT	25°	45°	60°	90°	125°
170 mm, 6 3/4"	<b>SC 8764</b>	<b>SC 8765</b>	<b>SC 8767</b>	<b>SC 8768</b>	<b>SC 8769</b>

**SLIM LINE POTTS**

TITANIT	25°	45°	60°	90°	125°
130 mm, 5"	<b>SC 8761</b>	<b>SC 8771</b>	<b>SC 8781</b>	<b>SC 8783</b>	<b>SC 8785</b>
185 mm, 7"	<b>SC 8760</b>	<b>SC 8770</b>	<b>SC 8780</b>	<b>SC 8710</b>	<b>SC 8711</b>

**POTTS**



<b>TITANIT</b>	25°	45°	60°	60° mit Knopf with balltip
180 mm, 7"			<b>SC 8562</b>	<b>SC 8691</b>
185 mm, 7 1/4"		<b>SC 8561</b>		
190 mm, 7 1/2"	<b>SC 8560</b>			

**POTTS-SMITH**

<b>Neo Intima Schere</b> feine flache Schneide stark gebogen <i>neo intima scissor</i> fine flat blades strongly curved		<b>S-gebogen</b>  <b>S-curved</b>
145 mm, 5 1/4"	<b>SC 2753</b>	
200 mm, 8"	<b>SC 2763</b>	<b>SC 2763S</b>

**GOLF**

**DEBUS**





**Gefäß-Schere**  
gerade 60°  
*Vascular scissor*  
straight 60°

220 mm, 8 3/4" Titanium

**SC 8805**

220 mm, 8 3/4" Power TC

**SC 0880**

**DE BAKEY**

speziell für/ specially for „Rezidive“	FINO Stahl FINO Steel	Standard Stahl Standard Steel	FINO TITANIT FINO TITANIT	Standard TITANIT <sup>®</sup> Standard TITANIT <sup>®</sup>
175mm, 6 1/2"	<b>SCB 7305</b>		<b>SCB 8150</b>	
194 mm, 7 3/4"	<b>SCB 7007</b>		<b>SCB 8007</b>	
220 mm, 8 3/4"	<b>SCB 7009</b>		<b>SCB 8009</b>	
267 mm, 10 1/2"	<b>SCB 7013</b>		<b>SCB 8013</b>	
280 mm, 11"	<b>SCB 7015</b>	<b>SCB 7025</b>	<b>SCB 8015</b>	<b>SCB 8025</b>

## POWER CUT

speziell geeignet für rezidive Indikation  
specially for recidive indication

Sie schneiden mühelos in vernarbtem Gewebe mit den ASANUS POWER CUT Scheren. Sie erhalten einen glatten, sauberen Schnitt, welcher sich auf die postoperative Heilung positiv auswirken kann.

*ASANUS POWER CUT scissors enable easy cutting in strongly pitted tissue. You will receive a smooth clear cutting area, which might enable a positive postoperative healing results of the tissue.*



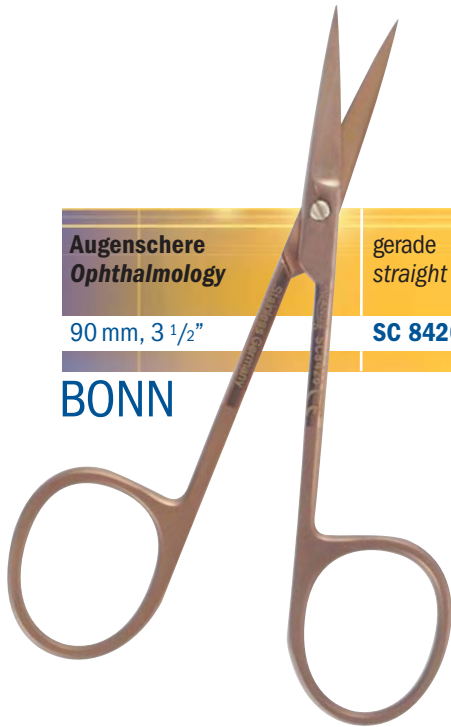

**Augenschere**  
*Ophthalmology*

90 mm, 3 1/2"

**BONN**

gerade  
straight

**SC 8426**

gebogen  
curved

**SC 8427**

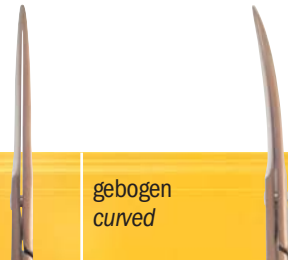

**Irisschere**  
*Iris scissor*

110 mm, 4 1/4"

**IRIS**

gerade  
straight

**SC 8410**

gebogen  
curved

**SC 8411**



gerade straight  
spitz sharp tips

**SC 8438**

gebogen curved  
spitz sharp tips

**SC 8439**

gerade straight  
stumpf blunt tips

**SC 8436**

gebogen curved  
stumpf blunt tips

**SC 8437**

115 mm, 4 1/2"

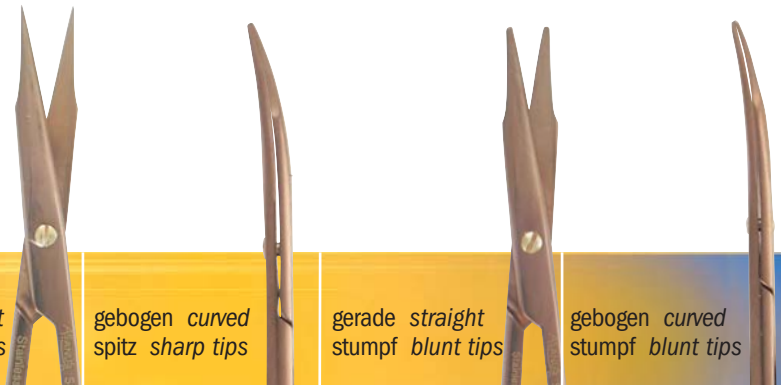

**TITANIT®**

Die Königsschere

- extrem lange Standzeiten
- lebenslang rostfrei
- extrem hart
- langjährig erprobt

**TITANIT®**

The king of scissors

- extrem long cutting duration
- no corrosion all life possible
- extrem hard
- longtime tested and in usage

**STEVENS**





**Tenotomie Blätter**  
**Tenotomy tips**

scharf; gebogen  
sharp, curved

130 mm, 5"

**SC 8733**

**TITANIT®**

Die Königsschere

- extrem lange Standzeiten
- lebenslang rostfrei
- extrem hart
- langjährig erprobt

**TITANIT®**

The king of scissors

- extrem long cutting duration
- no corrosion all life possible
- extrem hard
- longtime tested and in usage



gebogen, spitz  
curved, sharp tips

145 mm, 5 3/4"

**SC 8019**

**PLASTIC**



gerade  
straight

145 mm, 5 3/4"

**SC 8580**

gebogen  
curved

155 mm, 6 1/4"

**SC 8583**

**JOSEPH**

**Präparierschere mit feinen  
stumpfen Tenotomie Blättern**  
*Dissecting scissors with  
fine blunt tenotomy blades*

gebogen  
curved

125 mm, 5"

**SC 8447**

## STEVENS

**Präparierschere mit feinen,  
stumpfen und runden  
Tenotomie Blättern 1,2 mm**  
*Dissecting scissors with  
fine blunt round  
tenotomy blades 1,2 mm*

gebogen  
curved

145mm, 5 3/4"

**SC 8075**

156 mm, 6 1/4"

**SC 8730**

185 mm, 7"

**SC 8440**

230 mm, 9"

**SC 8441**

250 mm, 10"

**SC 8442**

## REYNOLDS

**feine  
Präparierschere**  
*delicate dissecting  
scissors*

stumpf/stumpf  
blunt tips  
2,0 mm

spitz/spitz  
sharp tips  
1,0 mm

stumpf/stumpf  
blunt tips  
2,5 mm

150 mm, 6"

**SC 8515**

**SC 8002**

**SC 8004**

## SALZBURG

**TITANIT®**

- Die Königsschere  
 - extrem lange Standzeiten  
 - lebenslang rostfrei  
 - extrem hart  
 - langjährig erprobt

**TITANIT®**

- The king of scissors  
 - extrem long cutting duration  
 - no corrosion all life possible  
 - extrem hard  
 - longlife tested and in usage



feine Präparierschere  
 fine dissecting scissor

150 mm, 6"

SC 8626



1/2

**SALZBURG**



standard  
 gebogen curved

180 mm, 7"

SC 8652

**KILNER**

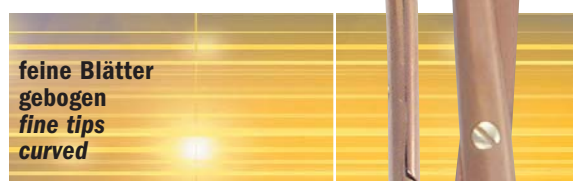

feine Blätter  
 gebogen  
 fine tips  
 curved

150 mm, 6"

SC 8651

180 mm, 7"

SC 8731

205mm, 8"

SC 8653

230 mm, 9"

SC 8654

260 mm, 10"

SC 8655

**RAGNELL-TUULA**



1/2



gebogen, S-gebogen  
 curved, S-curved

250 mm, 9 3/4"

SC 8660

**TUULA  
 PANKREAS**



1/2

<b>gebogen</b> <b>curved</b>	feine runde Blätter <i>fine round tips</i>	feine spitze Blätter <i>fine sharp tips</i>
180 mm, 7"	<b>SC 8140</b>	<b>SC 8141</b>
230 mm, 9"	<b>SC 8143</b>	

**LILLEHEY-POTTS**

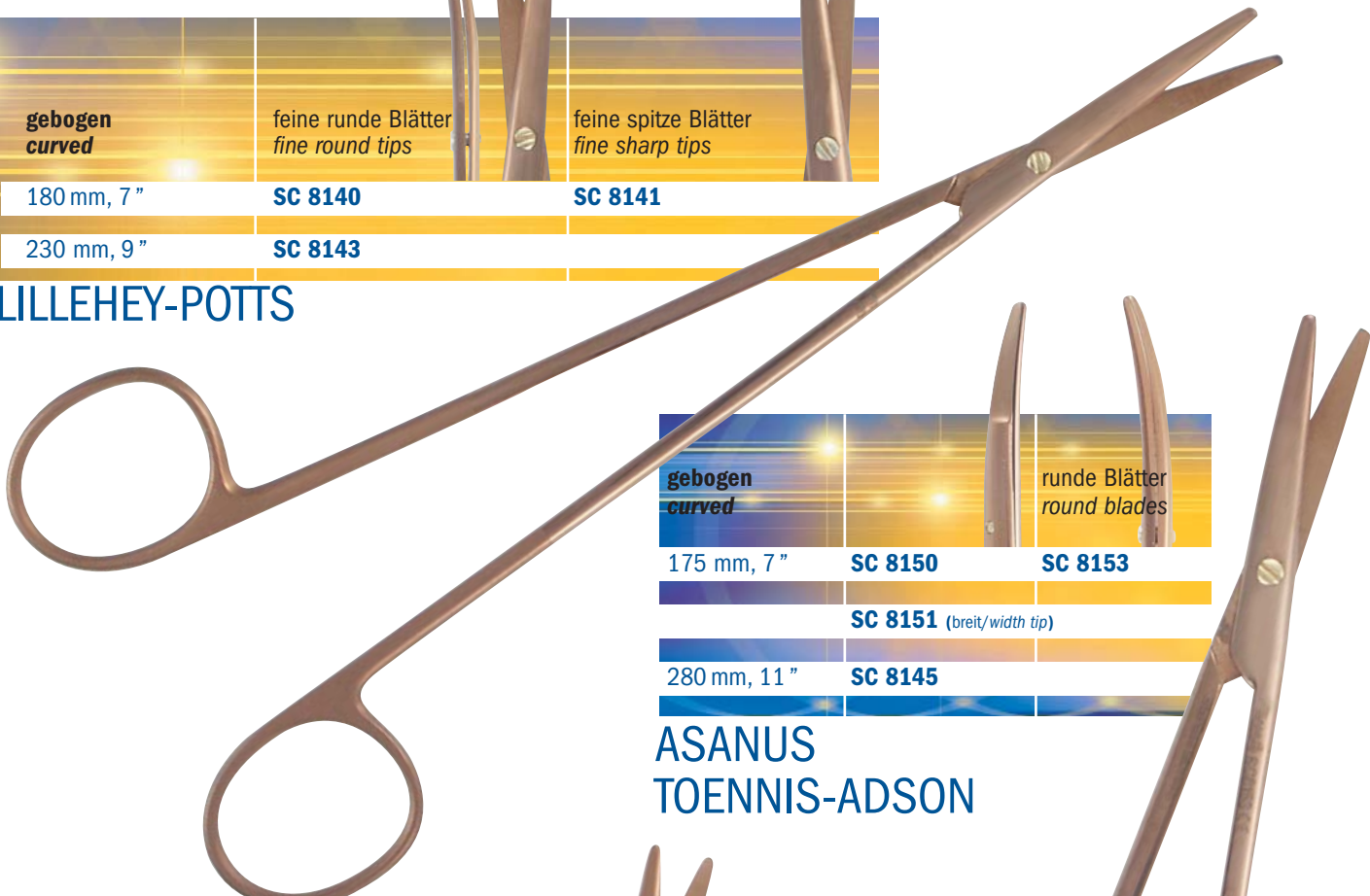

<b>gebogen</b> <b>curved</b>	runde Blätter <i>round blades</i>
175 mm, 7"	<b>SC 8150</b> <b>SC 8153</b>
	<b>SC 8151</b> (breit/ <i>width tip</i> )
280 mm, 11"	<b>SC 8145</b>

**ASANUS TOENNIS-ADSON**

<b>gebogen</b> <b>curved</b>	<b>gerade</b> <b>straight</b>
110 mm, 4 1/4"	<b>SC 8001</b> <b>SC 8000</b>
125 mm, 5"	<b>SC 8950</b>

**ASANUS METZENBAUM MINI STRABISMUS**

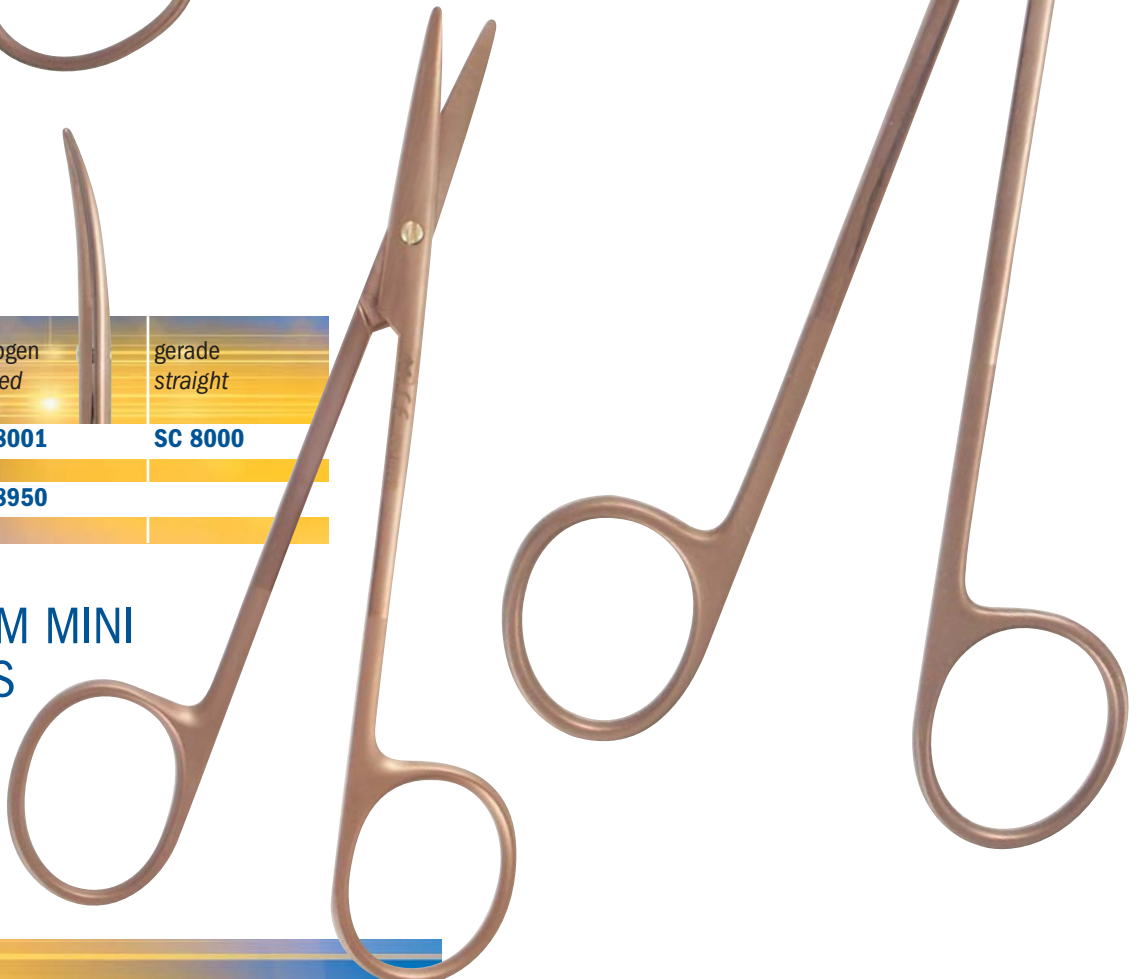

	gerade/straight stumpf/blunt		gebogen/curved stumpf/blunt		gebogen/curved stumpf/blunt		gebogen/curved spitz/sharp tips
145 mm, 5 3/4"	<b>SC 8280</b>	<b>SC 8281</b>				<b>SC 8313</b>	
177 mm, 7"						<b>SC 8315</b>	
180 mm, 7"		<b>SC 8283</b>					
200 mm, 8"				<b>SC 8285</b>			

## METZENBAUM-DELICATE

	gebogen/curved feine stumpfe Blätter delicate blunt tips		gebogen/curved
180 mm, 7"	<b>SC 8323-1</b>		
200 mm, 8"		<b>SC 8325</b>	

## METZENBAUM ULTRA FINO

	gebogen/curved sehr feine stumpfe Blätter delicate blunt tips	
180 mm, 7"	<b>SC 8323</b>	

## METZENBAUM ULTRA EXTREM



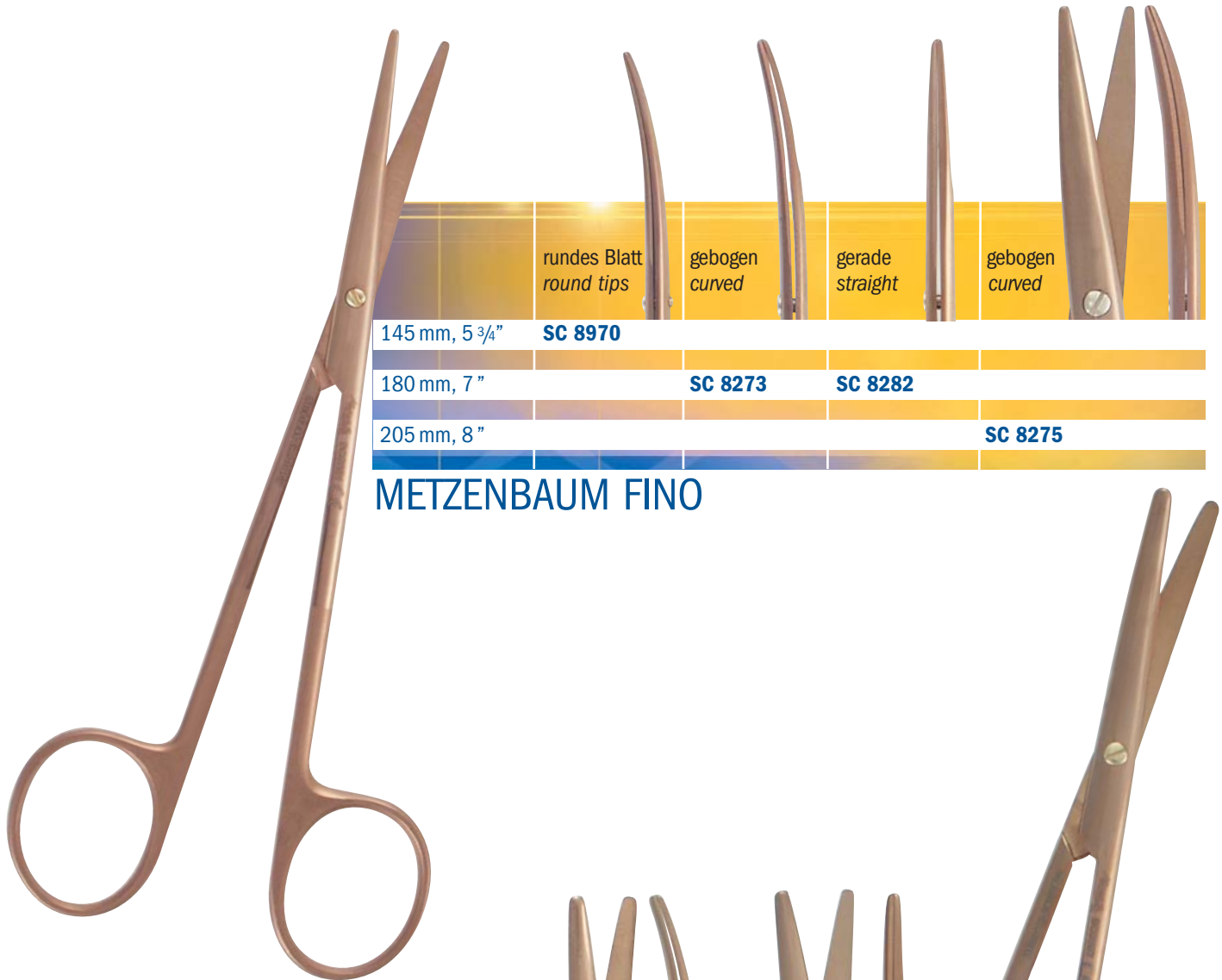

	rundes Blatt round tips	gebogen curved	gerade straight	gebogen curved
145 mm, 5 3/4"	<b>SC 8970</b>			
180 mm, 7"	<b>SC 8273</b>		<b>SC 8282</b>	
205 mm, 8"				<b>SC 8275</b>

**METZENBAUM FINO**

	gebogen curved	gerade straight
145 mm, 5 3/4"	<b>SC 8005</b>	
180 mm, 7"	<b>SC 8007</b>	<b>SC 8006</b>
200mm, 8"	<b>SC 8009</b>	<b>SC 8008</b>

**METZENBAUM**

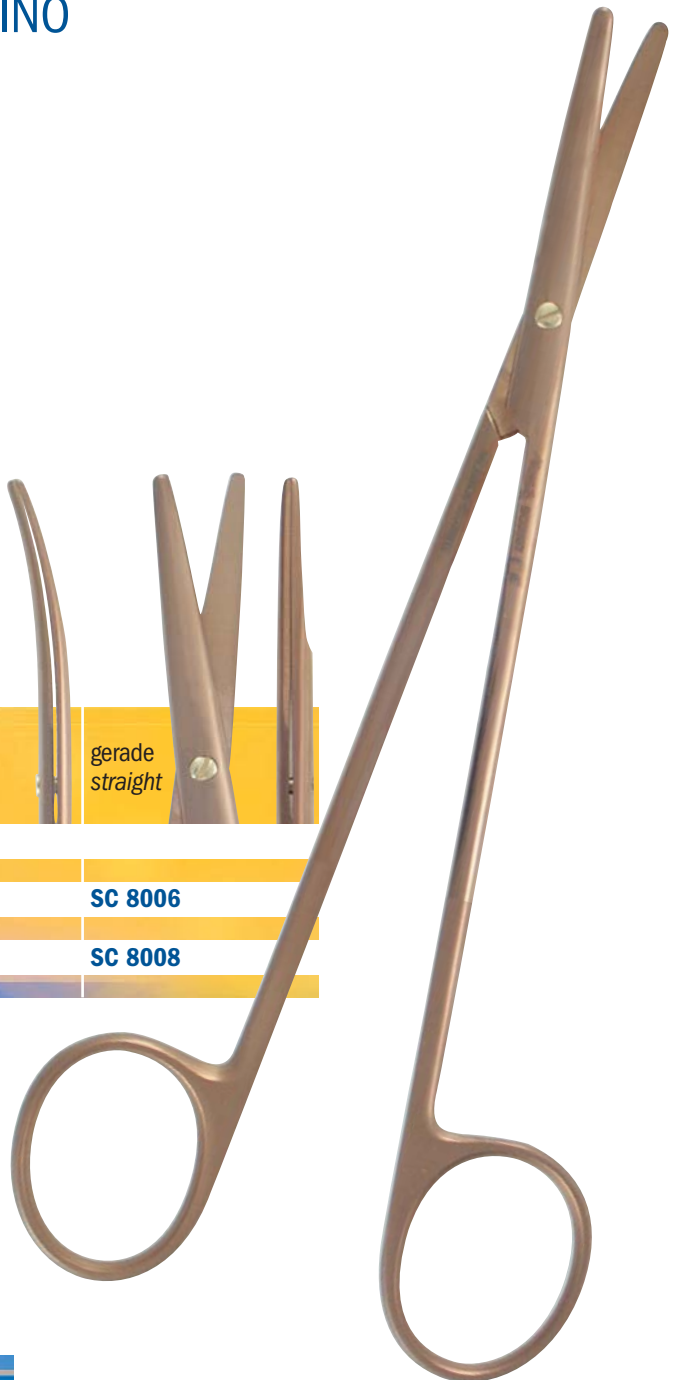

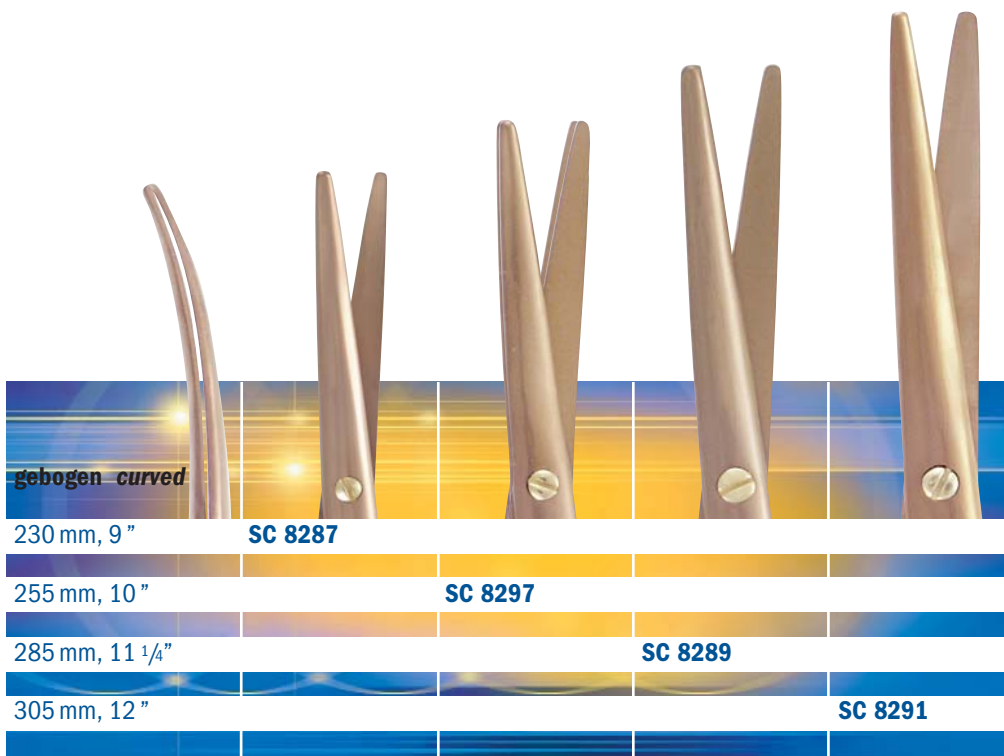

**METZENBAUM FINO**



**METZENBAUM**



<b>S-gebogen</b> <b>S-curved</b>			<b>FINO</b> 
180 mm, 7"	<b>SC 8057</b>		<b>SC 8057-F</b>
200 mm, 8"		<b>SC 8059</b>	
230 mm, 9"		<b>SC 8061</b>	<b>SC 8251</b>

**METZENBAUM-S**



<b>Tunnelierungsschere</b> <b>stark gebogen</b> <b>Tunneling scissor</b> <b>strongly curved</b>	stumpfe, feine runde Blätter <i>fine, blunt round tips</i>	feine spitze Blätter <i>fine sharp tips</i>
180 mm, 7"	<b>SC 8107</b> (Fino)	<b>SC 8105</b> (Fino)
	<b>SC 8107-1</b> (Delikat)	<b>SC 8105-1</b> (Delikat)

**HAJEK**





	gerade straight	gebogen curved
150 mm, 6"	<b>SC 8096</b>	<b>SC 8097</b>
170 mm, 6 3/4"	<b>SC 8098</b>	<b>SC 8999</b>
192 mm, 7 1/2"		<b>SC 8930</b>

**MAYO-STILLE**

schmales Blatt delicate tips	gebogen curved
154 mm, 5 3/4"	<b>SC 8934</b>

**MAYO FINO**

gebogen curved	gerade straight
165mm, 6 1/2"	<b>SC 8310</b>
	<b>SC 8308</b>

**LEXER**

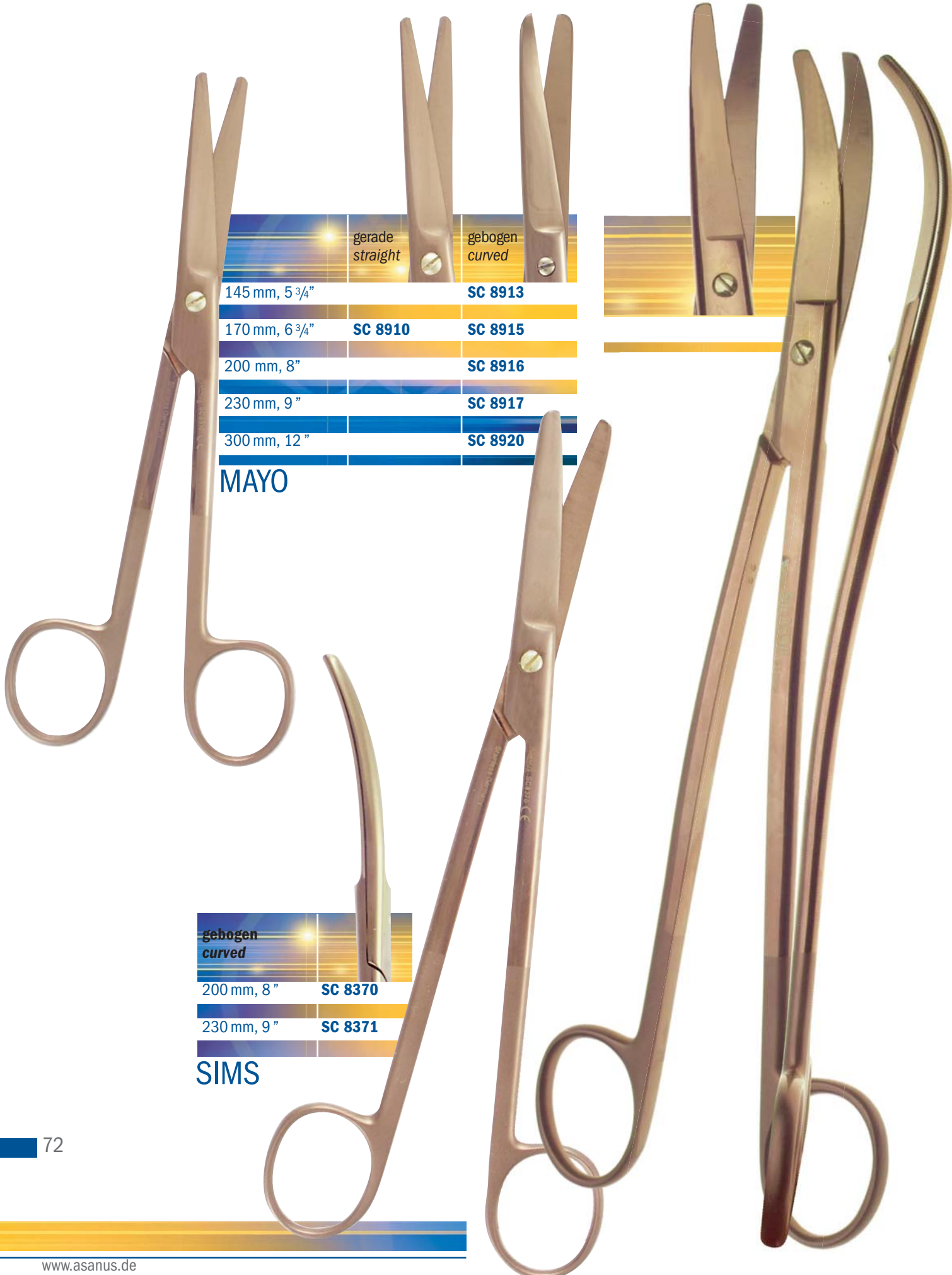

	gerade straight	gebogen curved
145 mm, 5 3/4"		<b>SC 8913</b>
170 mm, 6 3/4"	<b>SC 8910</b>	<b>SC 8915</b>
200 mm, 8"		<b>SC 8916</b>
230 mm, 9"		<b>SC 8917</b>
300 mm, 12"		<b>SC 8920</b>

**MAYO**

gebogen curved	
200 mm, 8"	<b>SC 8370</b>
230 mm, 9"	<b>SC 8371</b>

**SIMS**



	gerade/straight spitz/stumpf sharp/blunt	gebogen/curved spitz/stumpf sharp/blunt	gerade/straight stumpf/stumpf blunt/blunt	gebogen/curved stumpf/stumpf blunt/blunt	gerade/straight spitz/spitz sharp/sharp	gebogen/curved spitz/spitz sharp/sharp
115 mm, 4 1/2"		<b>SC 8867</b>				<b>SC 8810</b>
145 mm, 5 3/4"	<b>SC 8870</b>		<b>SC 8880</b>	<b>SC 8463</b>	<b>SC 8874</b>	<b>SC 8452</b>
170 mm, 6 3/4"	<b>SC 8451</b>			<b>SC 8467</b>		
185 mm, 7 1/4"		<b>SC 8871</b>				

COOPER



<b>Bauchdeckenschere, stark stumpf/stumpf Abdominal Scissor, strong blunt/blunt</b>	gerade straight	gebogen curved
185 mm, 7"	<b>SC 8032</b>	<b>SC 8033</b>

**schlankes Modell**  
gerade, spitz/stumpf  
**slim type**  
straight, sharp/blunt

145 mm, 5 3/4" **SC 8450**

**COOPER-SLIM**



115 mm, 4 1/2" **SC 8130**

**EISELSBERG**



**Verbandstoffschere**  
**bandage scissor**

140 mm, 5 1/2" **SC 8219**

180 mm, 7" **SC 8221**

200 mm, 8" **SC 8225**

**LISTER**



170 mm, 6 3/4" **SC 8750**

**SCHMIEDEN-  
TAYLOR**



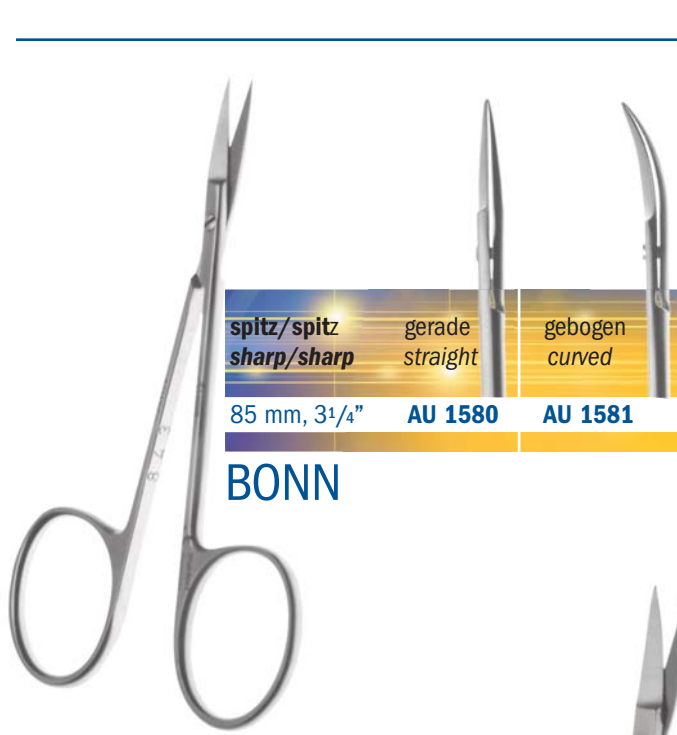

<b>spitz/spitz</b> <b>sharp/sharp</b>	gerade straight	gebogen curved
85 mm, 3 1/4"	<b>AU 1580</b>	<b>AU 1581</b>

**BONN**



<b>spitz/spitz, 45° aufgewinkelt</b> <b>sharp/sharp, 45° up angled</b>	
100 mm, 4"	<b>SC 0477</b>

**WILMER**

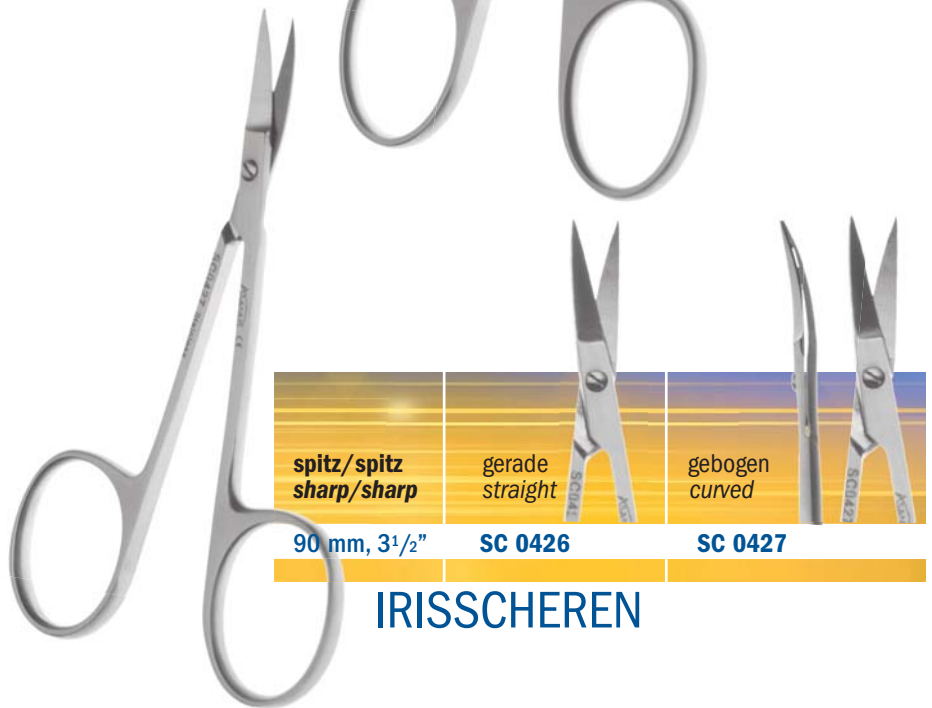

<b>spitz/spitz</b> <b>sharp/sharp</b>	gerade straight	gebogen curved
90 mm, 3 1/2"	<b>SC 0426</b>	<b>SC 0427</b>

**IRISSCHEREN**



gerade spitz/spitz straight sharp/sharp	gebogen spitz/spitz curved sharp/sharp	gerade spitz/stumpf straight sharp/blunt	gebogen spitz/stumpf curved sharp/blunt	seitwärts gebogen spitz/spitz curved to side sharp/sharp
110 mm, 4 1/4"	<b>SC 0430</b>	<b>SC 0431</b>	<b>SC 0432</b>	<b>SC 0433</b>
			<b>SC 0433</b>	<b>SC 0470</b>

**IRISSCHEREN**

**gerade  
spitz/stumpf  
straight  
sharp/blunt**

105 mm, 4 1/8"

**SC 1510**

115 mm, 4 1/2"

**SC 1512**

130 mm, 5"

**SC 1514**

145 mm, 5 3/4"

**SC 1516**

150 mm, 6"

**SC 1518**

**STANDARD**



**gerade  
spitz/stumpf  
straight  
sharp/blunt**

165 mm, 6 1/2"

**SC 1520**

175 mm, 7"

**SC 1522**

185 mm, 7 1/4"

**SC 1524**

200 mm, 8"

**SC 1526**

**STANDARD**







<b>gebogen</b> <b>spitz/stumpf</b> <b>curved</b> <b>sharp/blunt</b>				
	115 mm, 4 1/2"	<b>SC 1513</b>		
	130 mm, 5"		<b>SC 1515</b>	
	145 mm, 5 3/4"			<b>SC 1517</b>
	155 mm, 6"			<b>SC 1519</b>

**STANDARD**





<b>gebogen</b> <b>spitz/stumpf</b> <b>curved</b> <b>sharp/blunt</b>			
	165 mm, 6 1/2"	<b>SC 1521</b>	
	185 mm, 7 1/4"		<b>SC 1525</b>
	200 mm, 8"		<b>SC 1527</b>

**STANDARD**



<b>gerade stumpf/stumpf</b> <b>straight blunt/blunt</b>					
	105 mm, 4 1/8"	<b>SC 1456</b>			
	115 mm, 4 1/2"		<b>SC 1458</b>		
	130 mm, 5"			<b>SC 1460</b>	
	145 mm, 5 3/4"				<b>SC 1462</b>

**STANDARD**

<b>gerade stumpf/stumpf</b> <b>straight blunt/blunt</b>					
	155 mm, 6"	<b>SC 1464</b>			
	165 mm, 6 1/2"		<b>SC 1466</b>		
	185 mm, 7 1/4"			<b>SC 1468</b>	
	200 mm, 8"				<b>SC 1470</b>

**STANDARD**











<b>gebogen</b> <b>stumpf/stumpf</b> <b>curved</b> <b>blunt/blunt</b>					
	105 mm, 4 1/8"	<b>SC 1457</b>			
	115 mm, 4 1/2"		<b>SC 1459</b>		
	130 mm, 5"			<b>SC 1461</b>	
	145 mm, 5 3/4"				<b>SC 1463</b>

**STANDARD**







<b>gebogen</b> <b>stumpf/stumpf</b> <b>curved</b> <b>blunt/blunt</b>					
	155 mm, 6"	<b>SC 1465</b>			
	165 mm, 6 1/2"		<b>SC 1467</b>		
	185 mm, 7 1/4"			<b>SC 1469</b>	
	200 mm, 8"				<b>SC 1471</b>

**STANDARD**

<p><b>gerade spitz/spitz straight sharp/sharp</b></p>							
	105 mm, 4 1/8"	<b>SC 1598</b>					
	115 mm, 4 1/2"		<b>SC 1600</b>				
	130 mm, 5"			<b>SC 1602</b>			
	145 mm, 5 3/4"				<b>SC 1604</b>		
	150 mm, 6"					<b>SC 1606</b>	
	165 mm, 6 1/2"						<b>SC 1608</b>



**STANDARD**



<b>gebogen</b> <b>spitz/spitz</b> <b>curved</b> <b>sharp/sharp</b>						
	115 mm, 4 1/2"	<b>SC 1601</b>				
	130 mm, 5"		<b>SC 1603</b>			
	145 mm, 5 3/4"			<b>SC 1605</b>		
	150 mm, 6"				<b>SC 1607</b>	
	165 mm, 6 1/2"					<b>SC 1609</b>



**STANDARD**



		
<b>stumpf/stumpf</b> <b>blunt/blunt</b>	gerade straight	gebogen curved
115 mm, 4 1/2"	<b>SC 0690</b>	<b>SC 0691</b>





**STEVENS** STANDARD

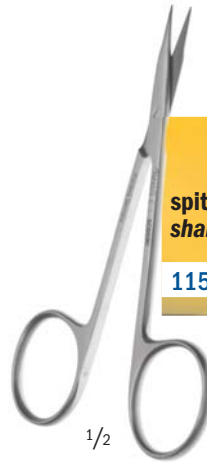

		
<b>spitz/spitz</b> <b>sharp/sharp</b>	gerade straight	gebogen curved
115 mm, 4 1/2"	<b>SC 0670</b>	<b>SC 0671</b>



**STEVENS** STANDARD

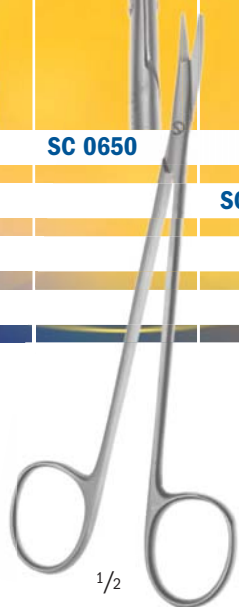

				
<b>gebogen mit flacher Spitze</b> <b>curved with flat point</b>				
120 mm, 4 3/4"	<b>SC 0650</b>			
150 mm, 6"		<b>SC 0651</b>		
180 mm, 7"			<b>SC 0656</b>	
200 mm, 8"				<b>SC 0658</b>

**KILNER** STANDARD



	
<b>gebogen, stumpf</b> <b>curved, blunt</b>	
150 mm, 6"	<b>SC 0200</b>

**REYNOLDS-JAMESON**  
STANDARD



gebogen, stumpf  
curved, blunt

150 mm, 6"

SC 0719

JAMESON STANDARD



1/2

gebogen, stumpf  
curved, blunt

150 mm, 6"

SC 0720

180 mm, 7"

SC 0722

REYNOLDS STANDARD



1/2

gerade  
straight

150 mm, 6"

SC 2090

170 mm, 6 3/4"

SC 2092

MAYO-STILLE STANDARD



1/2

gebogen  
curved

150 mm, 6"

SC 2091

170 mm, 6 3/4"

SC 2093

MAYO-STILLE STANDARD



1/2

<sup>1/1</sup>

**gerade  
straight**

145 mm, 5 3/4"	<b>SC 1930</b>
170 mm, 6 3/4"	<b>SC 1932</b>
230 mm, 9"	<b>SC 1934</b>

**MAYO STANDARD**

<sup>1/2</sup>

<sup>1/1</sup>

**gebogen  
curved**

145 mm, 5 3/4"	<b>SC 1940</b>
170 mm, 6 3/4"	<b>SC 1942</b>
190 mm, 8 1/4"	<b>SC 1943</b>
230 mm, 9"	<b>SC 1944</b>

**MAYO STANDARD**



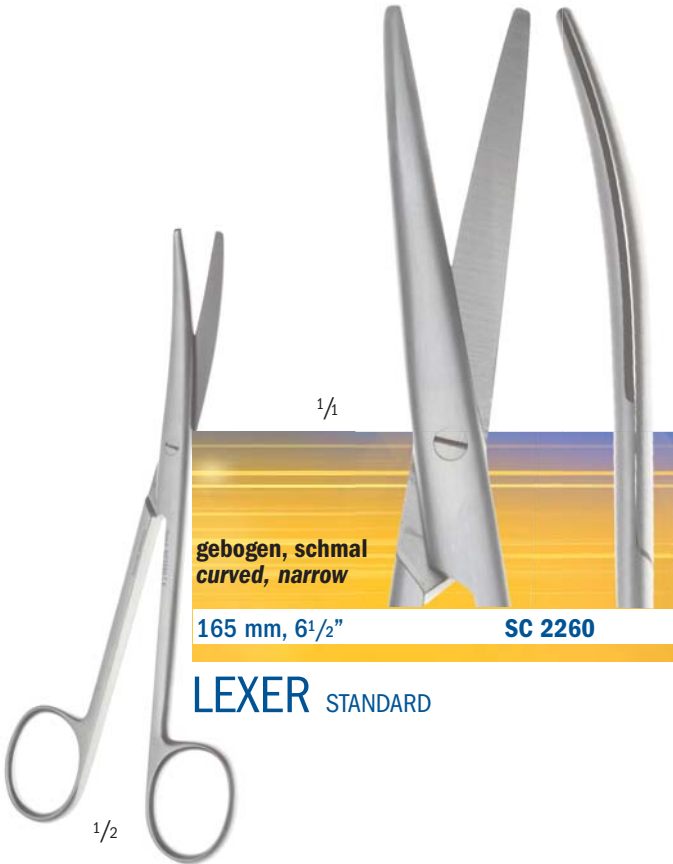

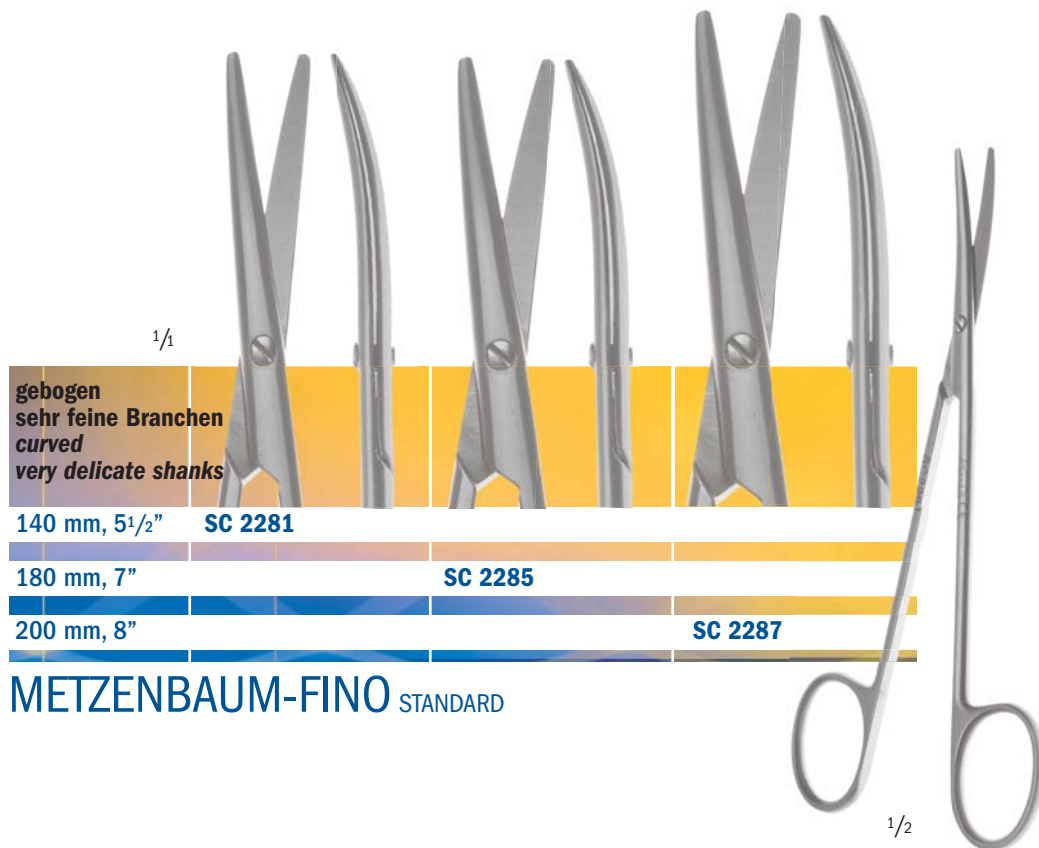
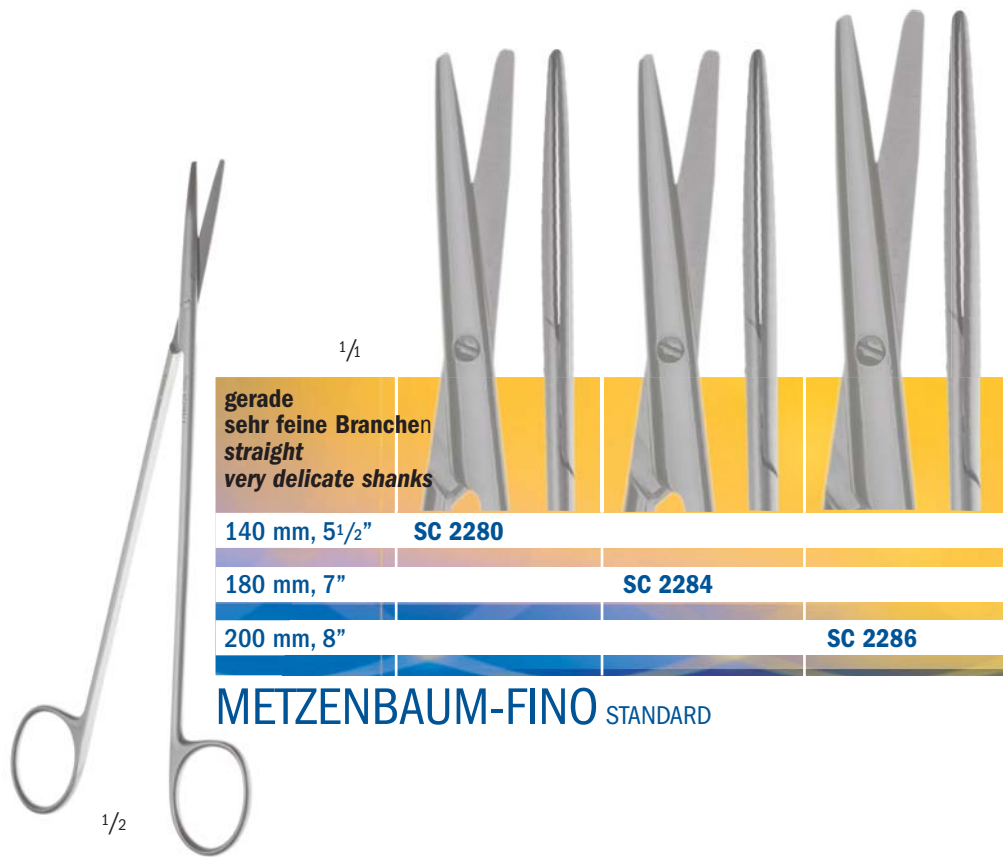
<sup>1/2</sup>















<b>gerade</b> <b>sehr feine Branchen</b> <b>straight</b> <b>very delicate shanks</b>					
230 mm, 9"	<b>SC 2288</b>				
260 mm, 10"	<b>SC 2290</b>				
280 mm, 11"	<b>SC 2292</b>				

**METZENBAUM-FINO** STANDARD



<b>gebogen</b> <b>sehr feine Branchen</b> <b>curved</b> <b>very delicate shanks</b>					
230 mm, 9"	<b>SC 2289</b>				
260 mm, 10"	<b>SC 2291</b>				
280 mm, 11"	<b>SC 2293</b>				

**METZENBAUM-FINO** STANDARD

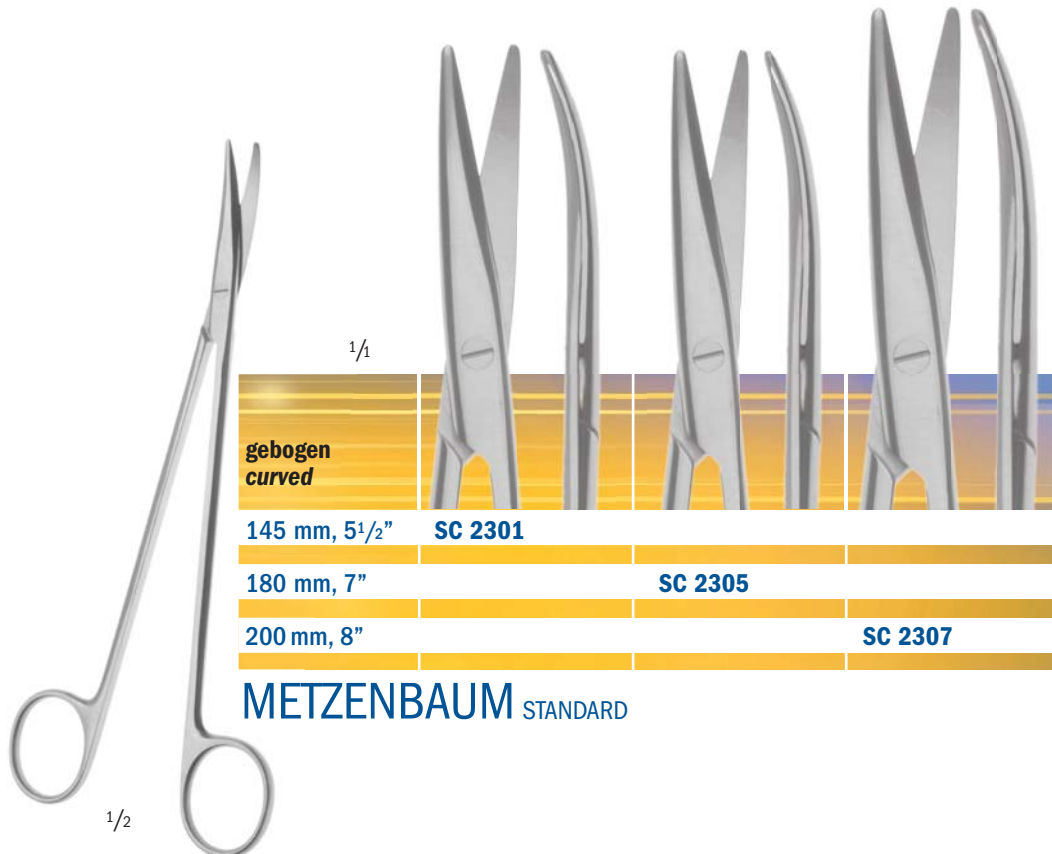
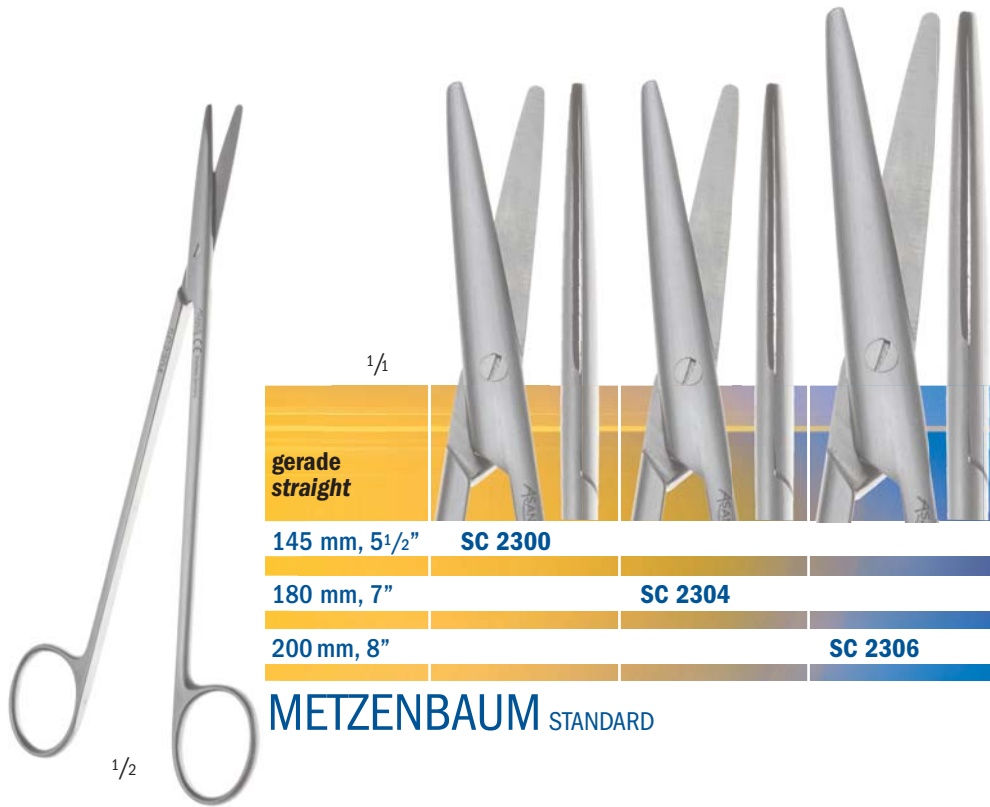



	$\frac{1}{4}$	$\frac{1}{4}$	$\frac{1}{4}$	$\frac{1}{4}$
<b>gerade straight</b>				
230 mm, 9"	<b>SC 2308</b>			
260 mm, 10"		<b>SC 2310</b>		
280 mm, 11"			<b>SC 2312</b>	
300 mm, 12"				<b>SC 2314</b>

**METZENBAUM** STANDARD



	$\frac{1}{4}$	$\frac{1}{4}$	$\frac{1}{4}$	$\frac{1}{4}$
<b>gebogen curved</b>				
230 mm, 9"	<b>SC 2309</b>			
260 mm, 10"		<b>SC 2311</b>		
280 mm, 11"			<b>SC 2313</b>	
300 mm, 12"				<b>SC 2315</b>

**METZENBAUM** STANDARD

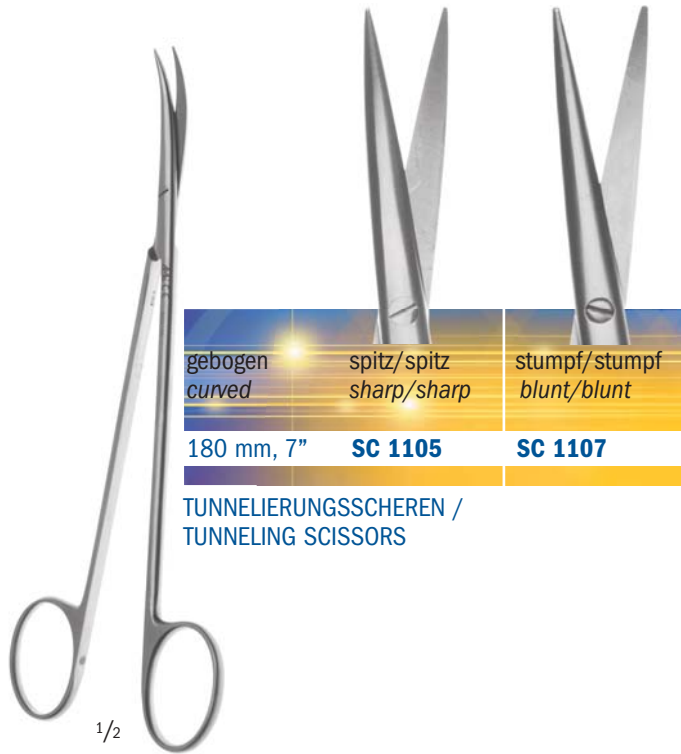

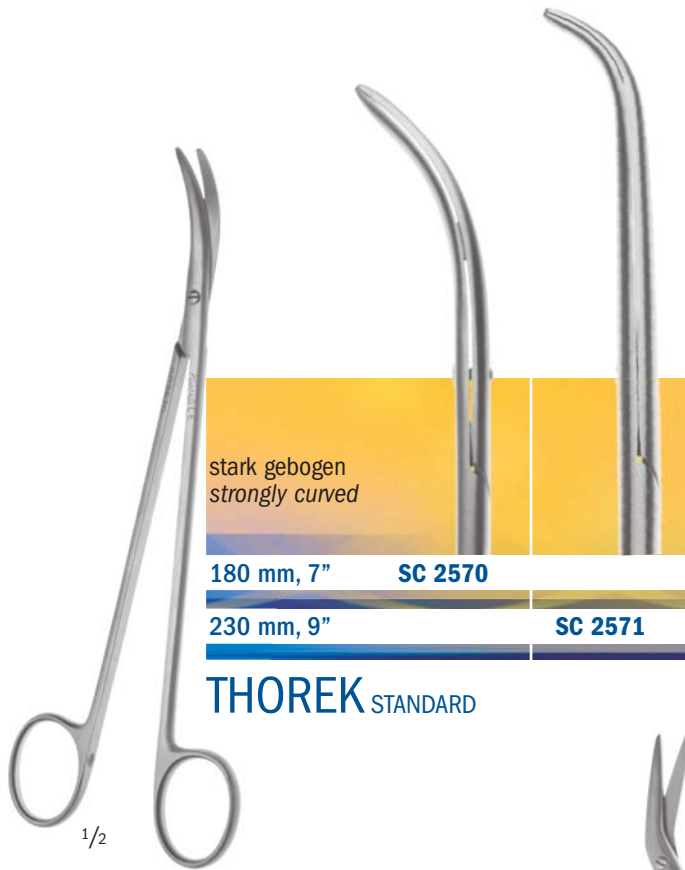

stark gebogen  
strongly curved

180 mm, 7" SC 2570

230 mm, 9" SC 2571

**THOREK** STANDARD



S-gebogen  
S-sharped

20°

45°

160 mm, 6" SC 2799

SC 2800

**DE BAKEY** STANDARD

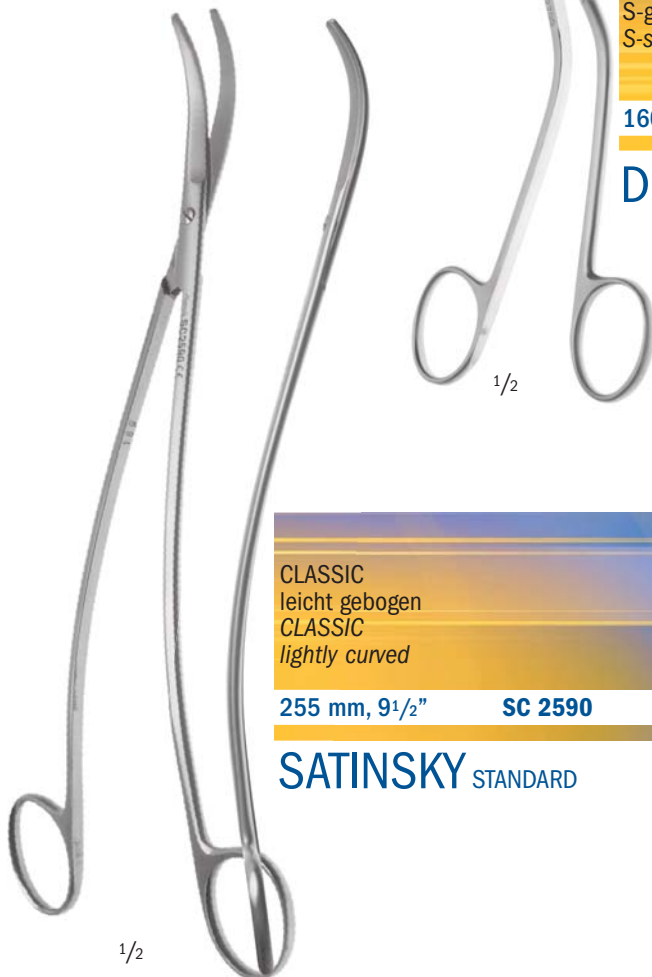

CLASSIC  
leicht gebogen  
CLASSIC  
lightly curved

255 mm, 9 1/2" SC 2590

**SATINSKY** STANDARD

**SUPERCUT** Scheren zeichnen sich durch eine extrem scharfe Schneideklinge aus, welche selbst in schwierigen Schneidbereichen ein ausgezeichnetes Schnittergebnis erzielen.

**SUPERCUT** Scissors are been manufactured with an extrem razor sharp edge, which allow easy and smooth cutting even in difficult areas.

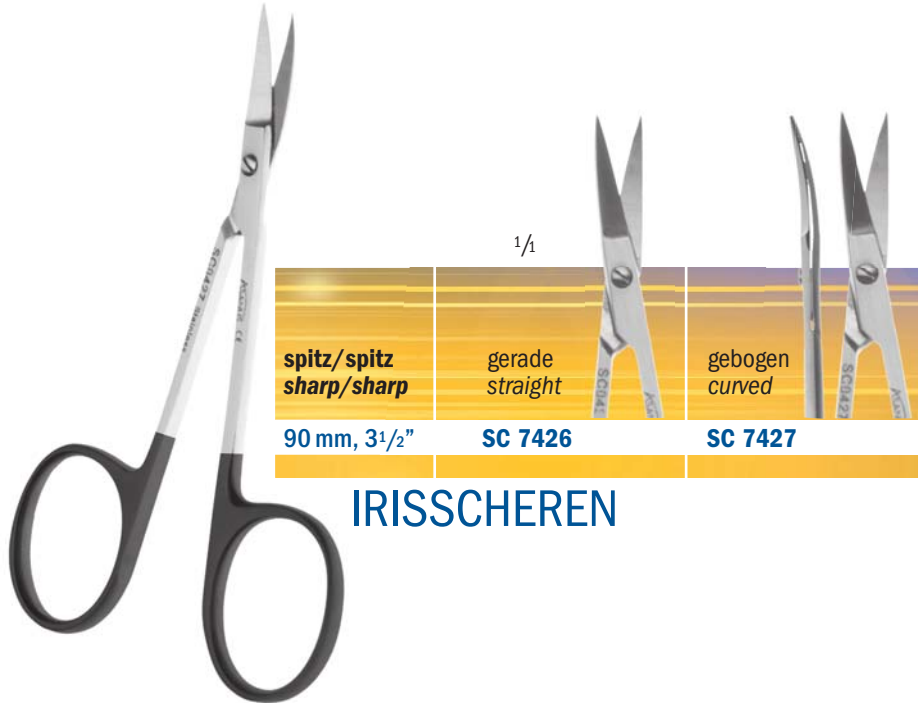

**IRISSCHEREN**

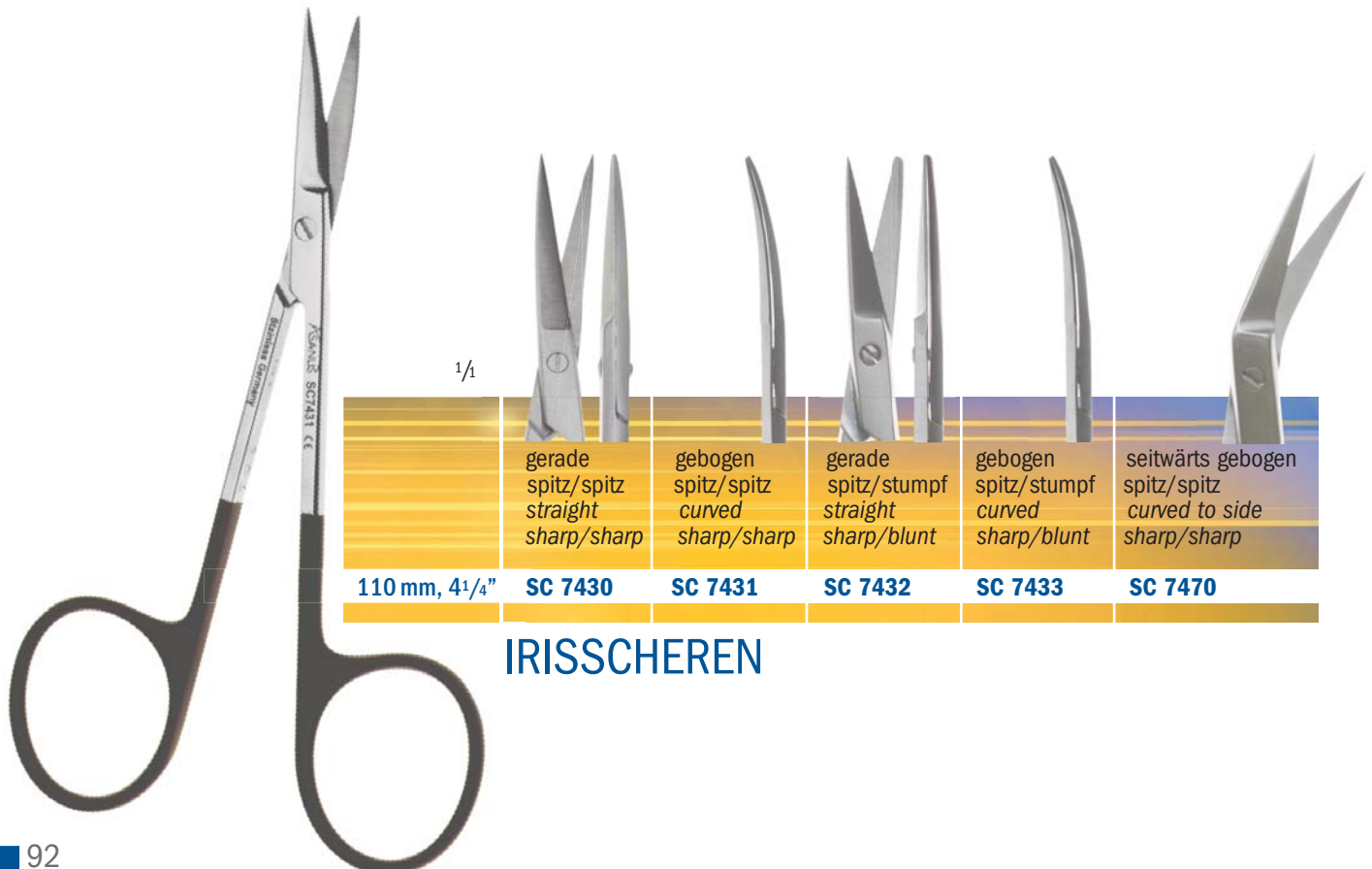

**IRISSCHEREN**

<p><math>\frac{1}{1}</math></p> <p>gerade spitz/stumpf straight sharp/blunt</p>					
	105 mm, 4 $\frac{1}{8}$ "	<b>SC 7510</b>			
	115 mm, 4 $\frac{1}{2}$ "		<b>SC 7512</b>		
	130 mm, 5"			<b>SC 7514</b>	
	145 mm, 5 $\frac{3}{4}$ "				<b>SC 7516</b>
	150 mm, 6"				

STANDARD



<p><math>\frac{1}{1}</math></p> <p>gerade spitz/stumpf straight sharp/blunt</p>			
	165 mm, 6 $\frac{1}{2}$ "	<b>SC 7520</b>	
	185 mm, 7 $\frac{1}{4}$ "		<b>SC 7524</b>
	200 mm, 8"		<b>SC 7526</b>

STANDARD



<sup>1/1</sup>

<b>gebogen spitz/stumpf curved sharp/blunt</b>					
115 mm, 4 1/2"	<b>SC 7513</b>				
130 mm, 5"			<b>SC 7515</b>		
145 mm, 5 3/4"				<b>SC 7517</b>	
155 mm, 6"					<b>SC 7519</b>

**STANDARD**

<sup>1/1</sup>

<b>gebogen spitz/stumpf curved sharp/blunt</b>				
165 mm, 6 1/2"	<b>SC 7521</b>			
185 mm, 7 1/4"			<b>SC 7525</b>	
200 mm, 8"				<b>SC 7527</b>

**STANDARD**





<p><sup>1/1</sup></p> <p>gerade stumpf/stumpf straight blunt/blunt</p>						
	105 mm, 4 1/8"	SC 7486				
	115 mm, 4 1/2"	SC 7488				
	130 mm, 5"	SC 7490				
	145 mm, 5 3/4"	SC 7492				

STANDARD

<p><sup>1/1</sup></p> <p>gerade stumpf/stumpf straight blunt/blunt</p>						
	155 mm, 6"	SC 7494				
	165 mm, 6 1/2"	SC 7496				
	185 mm, 7 1/4"	SC 7498				
	200 mm, 8"	SC 7500				

STANDARD



<p>gebogen stumpf/stumpf curved blunt/blunt</p>				
	105 mm, 4 1/8"	<b>SC 7037</b>		
	115 mm, 4 1/2"		<b>SC 7039</b>	
	130 mm, 5"			<b>SC 7041</b>
	145 mm, 5 3/4"			<b>SC 7043</b>

**STANDARD**

<p>gebogen stumpf/stumpf curved blunt/blunt</p>				
	155 mm, 6"	<b>SC 7045</b>		
	165 mm, 6 1/2"		<b>SC 7047</b>	
	185 mm, 7 1/4"			<b>SC 7049</b>
	200 mm, 8"			<b>SC 7051</b>

**STANDARD**

<sup>1/1</sup>

<b>gerade spitz/spitz straight sharp/sharp</b>						
105 mm, 4 1/8"	<b>SC 7598</b>					
115 mm, 4 1/2"		<b>SC 7580</b>				
130 mm, 5"			<b>SC 7582</b>			
145 mm, 5 3/4"				<b>SC 7584</b>		
155 mm, 6"					<b>SC 7586</b>	
165 mm, 6 1/2"						<b>SC 7588</b>

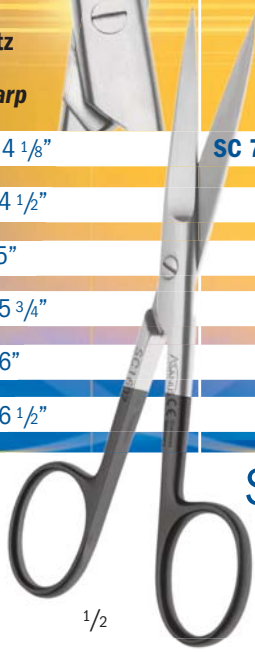

STANDARD

<sup>1/2</sup>

<b>gebogen spitz/spitz curved sharp/sharp</b>					
115 mm, 4 1/2"	<b>SC 7581</b>				
130 mm, 5"		<b>SC 7583</b>			
145 mm, 5 3/4"			<b>SC 7585</b>		
155 mm, 6"				<b>SC 7587</b>	
165 mm, 6 1/2"					<b>SC 7589</b>



STANDARD

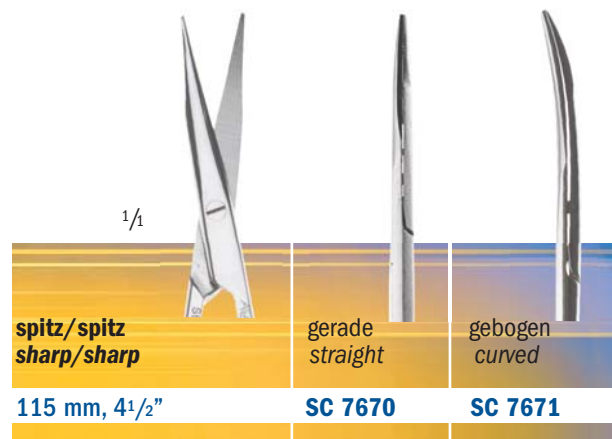
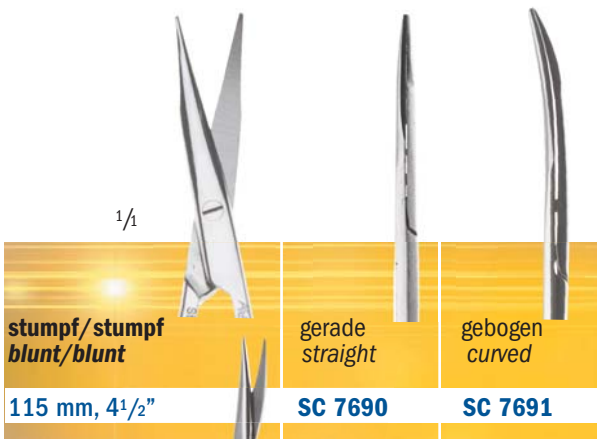

**STEVENS**

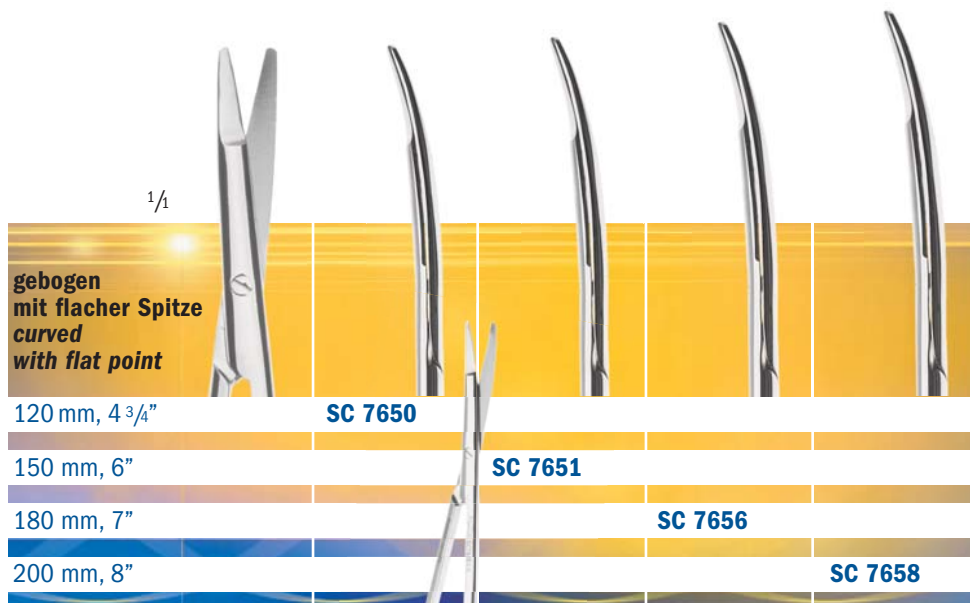

**KILNER**



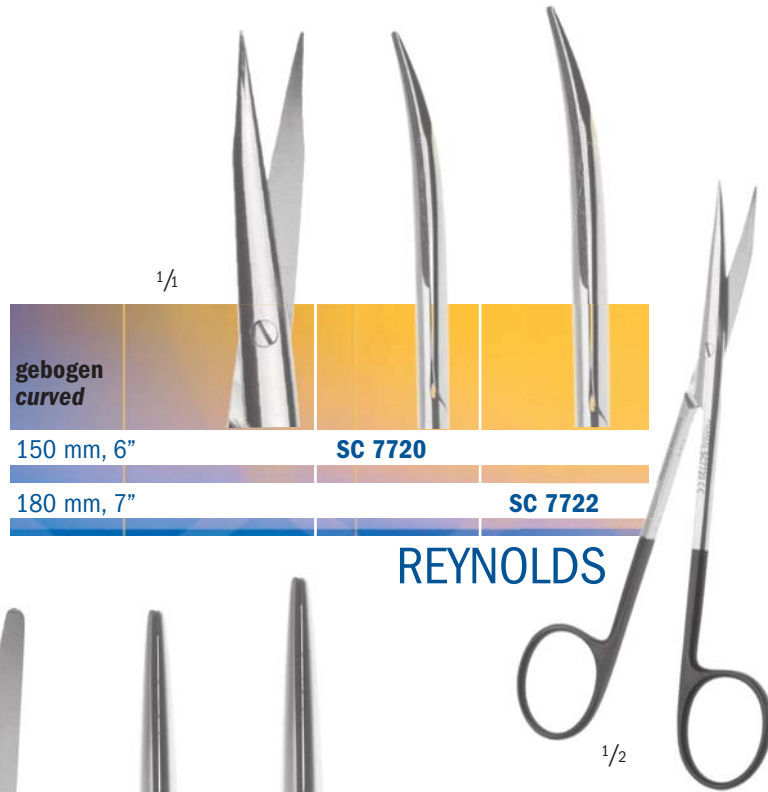

REYNOLDS



MAYO-STILLE



MAYO-STILLE

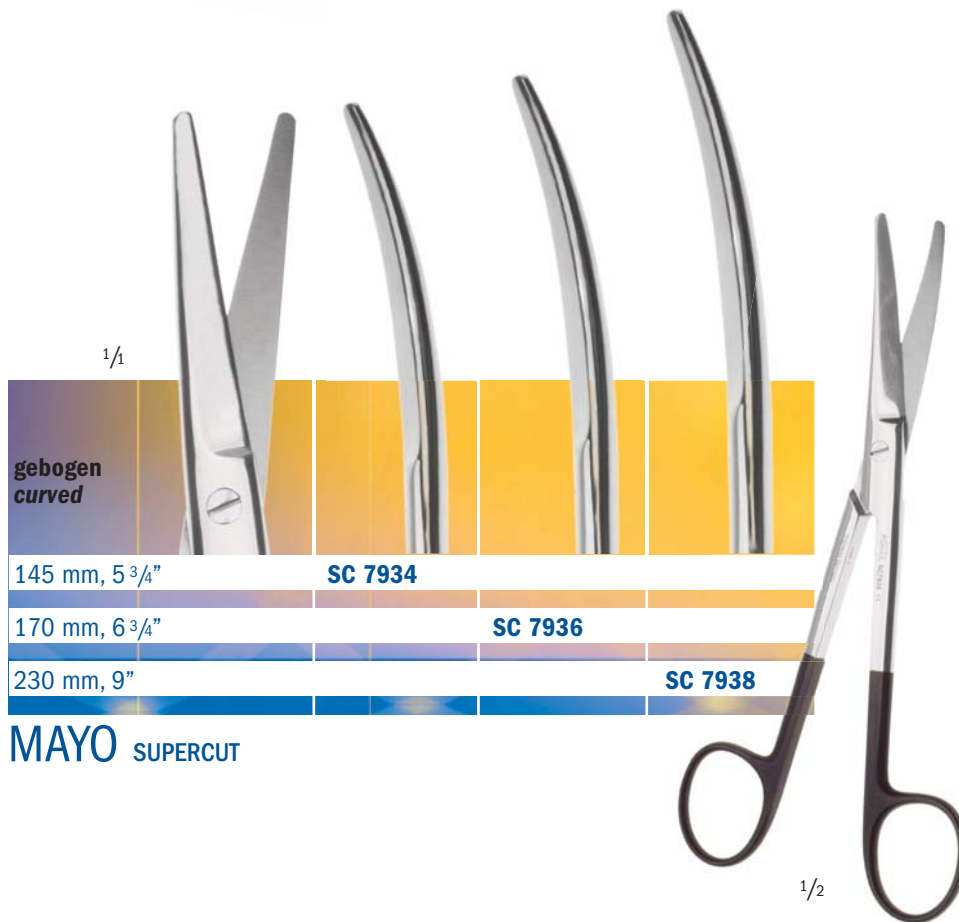



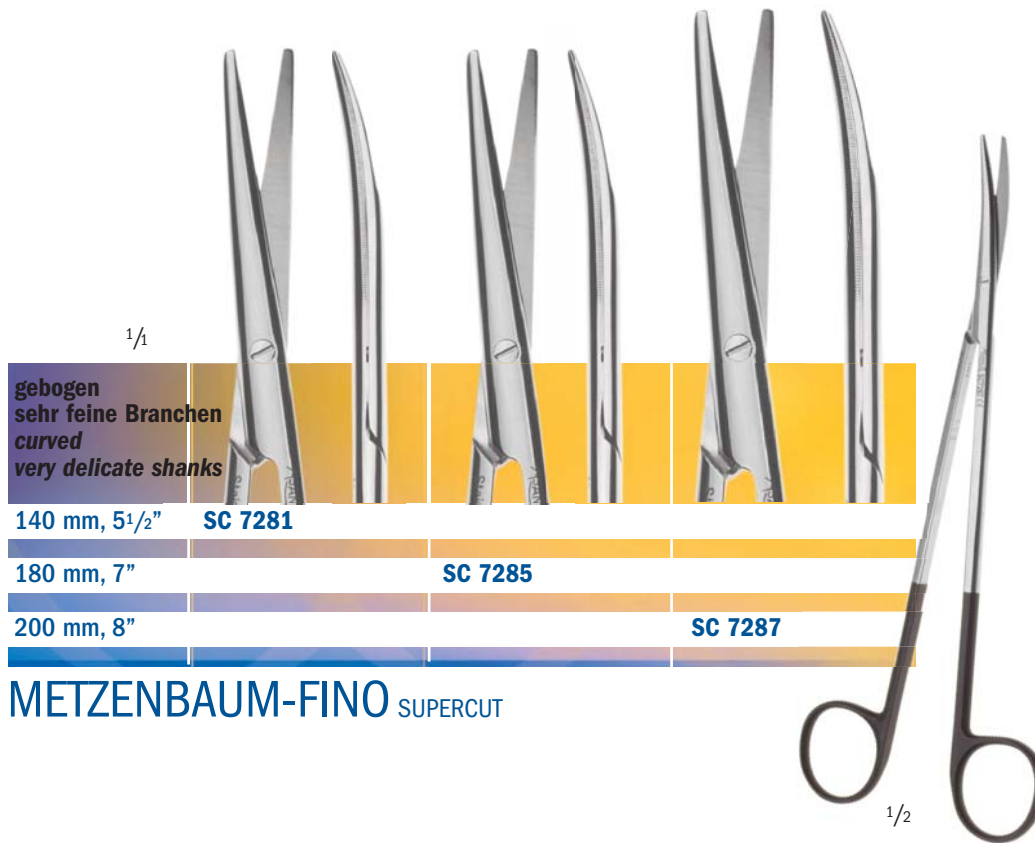
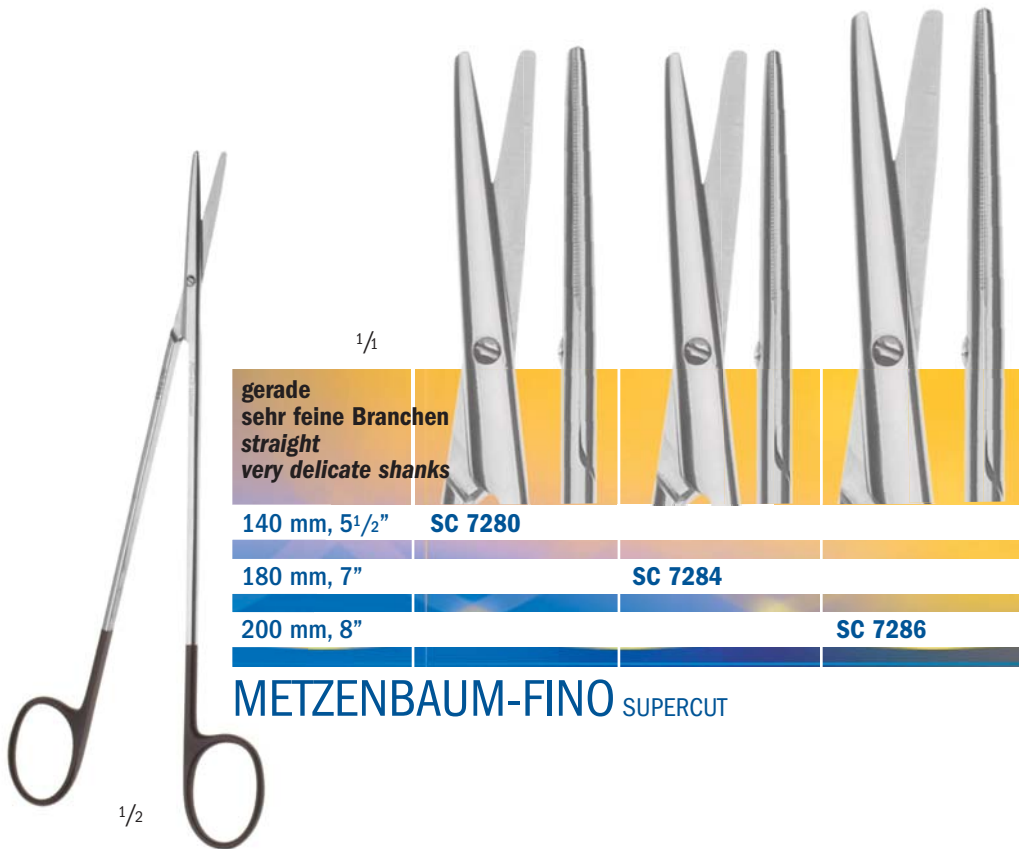





gerade  
sehr feine Branchen  
straight  
very delicate shanks

230 mm, 9"	SC 7288	
260 mm, 10"		SC 7290
280 mm, 11"		SC 7292

**METZENBAUM-FINO** SUPERCUT

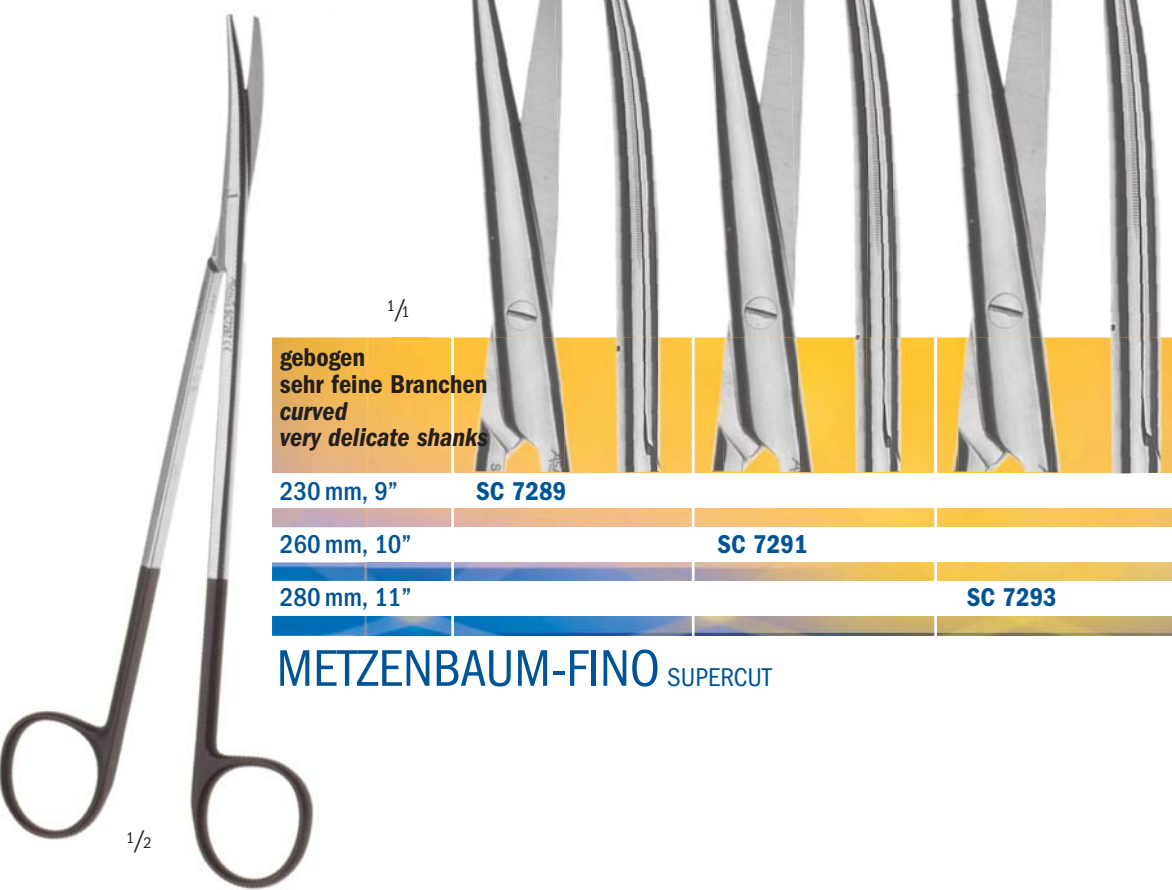

gebogen  
sehr feine Branchen  
curved  
very delicate shanks

230 mm, 9"	SC 7289	
260 mm, 10"		SC 7291
280 mm, 11"		SC 7293

**METZENBAUM-FINO** SUPERCUT

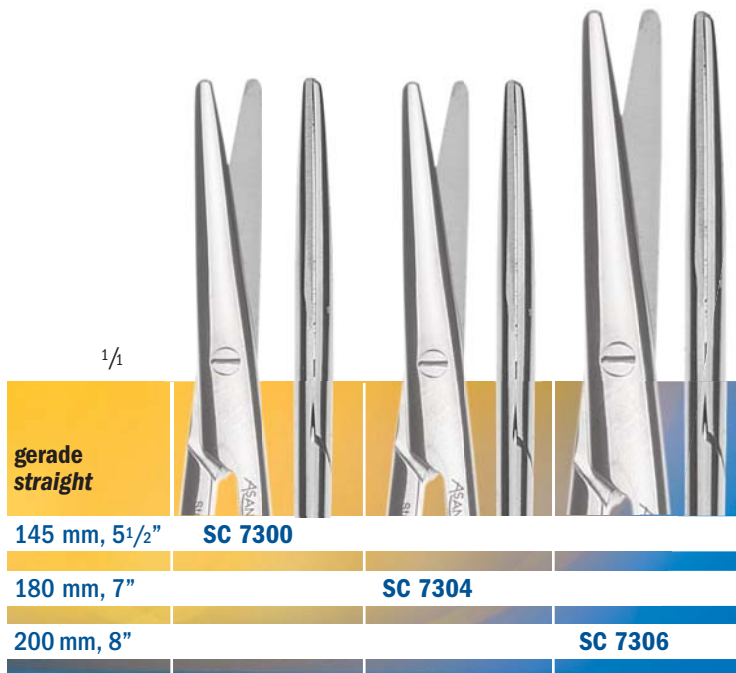

**METZENBAUM** SUPERCUT

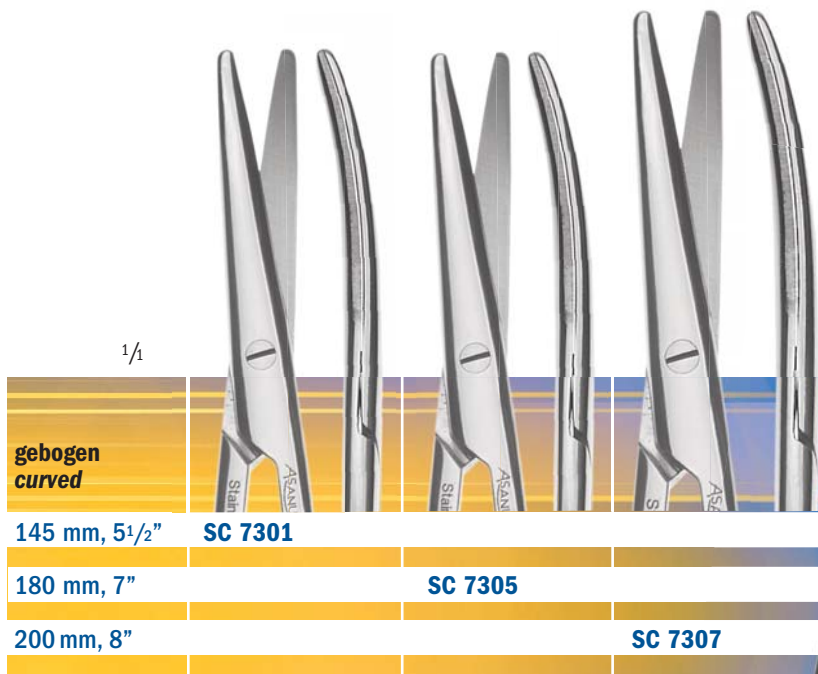

**METZENBAUM** SUPERCUT





1/1

<b>gerade straight</b>				
230 mm, 9"	<b>SC 7308</b>			
260 mm, 10"		<b>SC 7310</b>		
280 mm, 11"			<b>SC 7312</b>	
300 mm, 12"				<b>SC 7314</b>

**METZENBAUM** SUPERCUT



1/1

<b>gebogen curved</b>				
230 mm, 9"	<b>SC 7309</b>			
260 mm, 10"		<b>SC 7311</b>		
280 mm, 11"			<b>SC 7313</b>	
300 mm, 12"				<b>SC 7315</b>

**METZENBAUM** SUPERCUT

1/2

gebogen curved	200 mm, 8"	SC 7307S
	230 mm, 9"	SC 7309S
	250 mm, 10"	SC 7311S
	250 mm, 10" stark gebogen/strongly curved	SC 7311SS
	275 mm, 10 <sup>1</sup> / <sub>2</sub> "	SC 7313S

**METZENBAUM LIGHT**  
DIE SPEZIALSCHERE - SUPERLEICHT  
- POWER CUT SCHNEIDFUNKTION  
THE GENIUS SCISSOR - SUPERLIGHT  
- POWER CUT FUNCTION

gebogen  
sehr fein  
curved  
very delicate

180 mm, 7" SC 7140

**LILLEHEY POTTS**

gebogen  
fein  
curved  
delicate

180 mm, 7" SC 7530

**TÖNNIS-ADSON**





gerade spitz/spitz straight sharp/sharp	gebogen spitz/spitz curved sharp/sharp	gerade spitz/stumpf straight sharp/blunt	gebogen spitz/stumpf curved sharp/blunt	seitwärts gebogen spitz/spitz curved to side sharp/sharp	
110 mm, 4 1/4"	<b>SC 0800</b>	<b>SC 0429</b>	<b>SC 0442</b>	<b>SC 0443</b>	<b>SC 0475</b>

**IRISSCHEREN**

**POWER TC** Scheren sind mit einer Spezialklinge mit über 20% härterem Stahl in die Schneide eingearbeitet. Dies ermöglicht eine sehr hohe Schnittstandzeit und spart Reparatur- und Ersatzkosten.

***POWER TC** Scissors are manufactured with a special Tungsten Carbide Inlay which is more than 20% harder than Standard surgical scissor steel. Lower repair- and exchange cost make **POWER TC** scissors to a long durability scissor.*

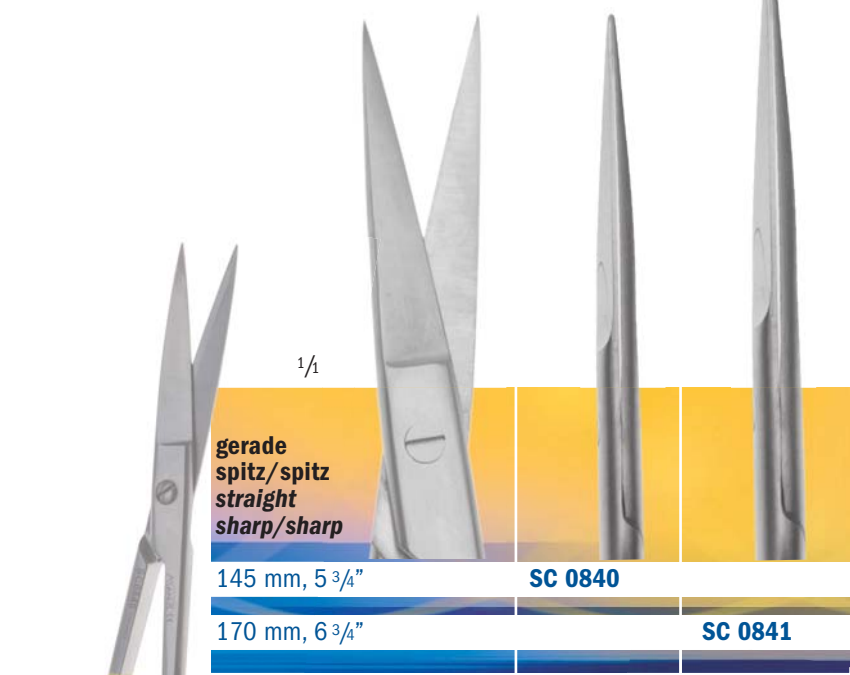

gerade spitz/spitz straight sharp/sharp		
145 mm, 5 3/4"	<b>SC 0840</b>	
170 mm, 6 3/4"		<b>SC 0841</b>

**STANDARD**

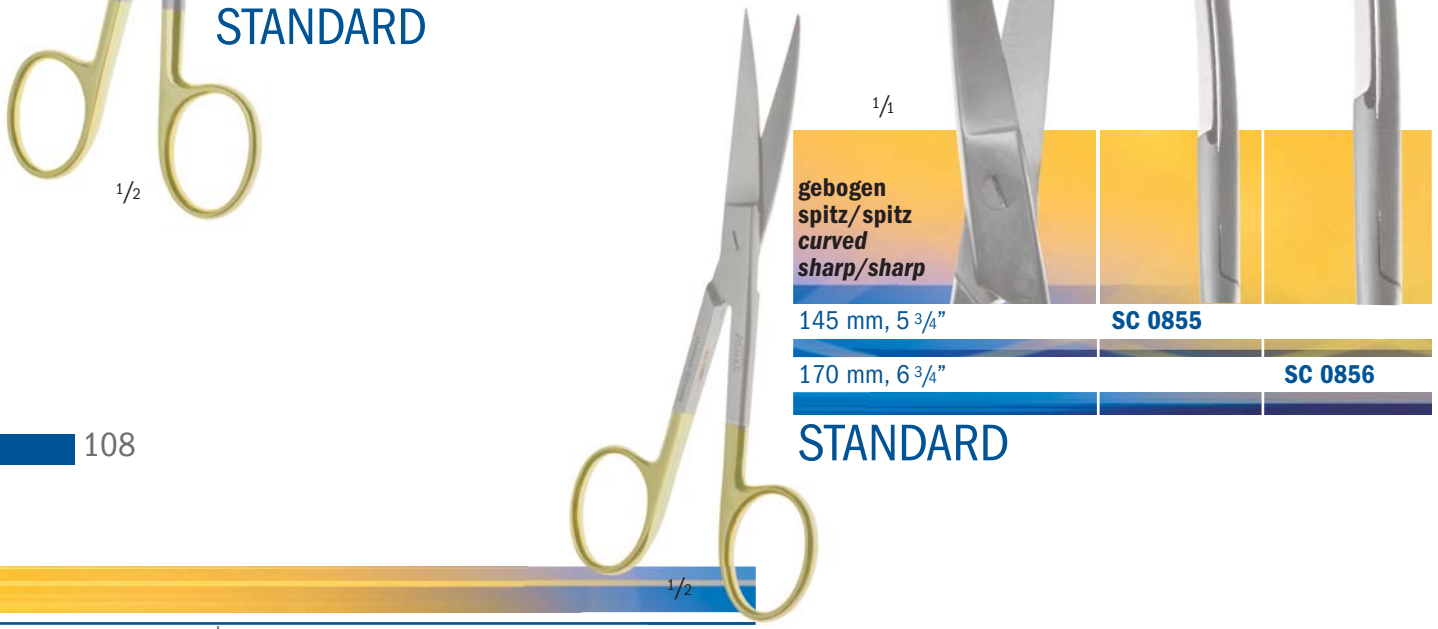



gebogen spitz/spitz curved sharp/sharp		
145 mm, 5 3/4"	<b>SC 0855</b>	
170 mm, 6 3/4"		<b>SC 0856</b>

**STANDARD**





1/2

<b>gerade</b> <b>spitz/stumpf</b> <b>straight</b> <b>sharp/blunt</b>			
	145 mm, 5 3/4"	<b>SC 0870</b>	
165 mm, 6 1/2"			<b>SC 0872</b>

**STANDARD**



1/2

<b>gebogen</b> <b>spitz/stumpf</b> <b>curved</b> <b>sharp/blunt</b>			
	145 mm, 5 3/4"	<b>SC 0871</b>	
165 mm, 6 1/2"			<b>SC 0873</b>

**STANDARD**

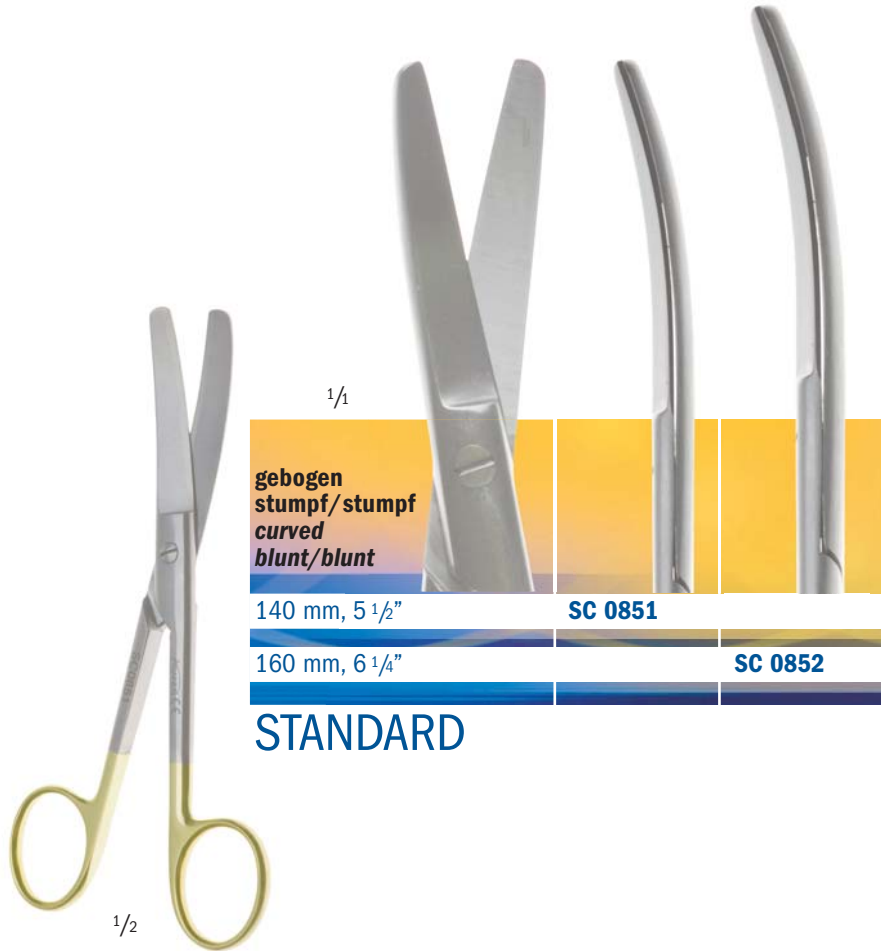



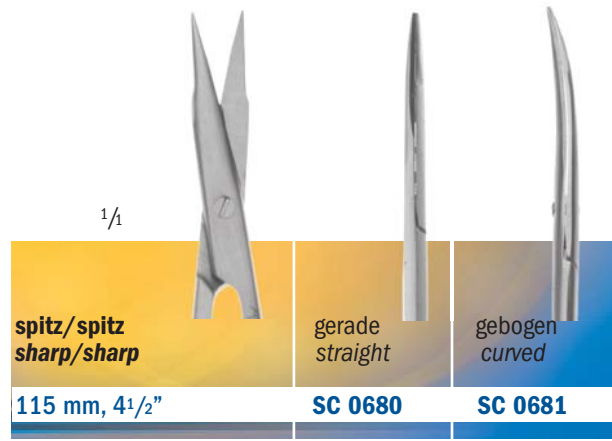
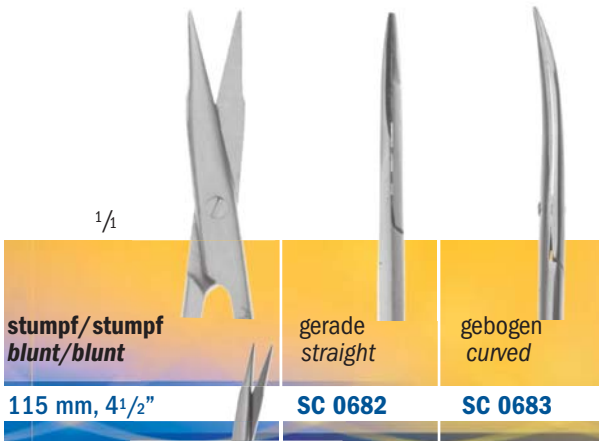

STEVENS

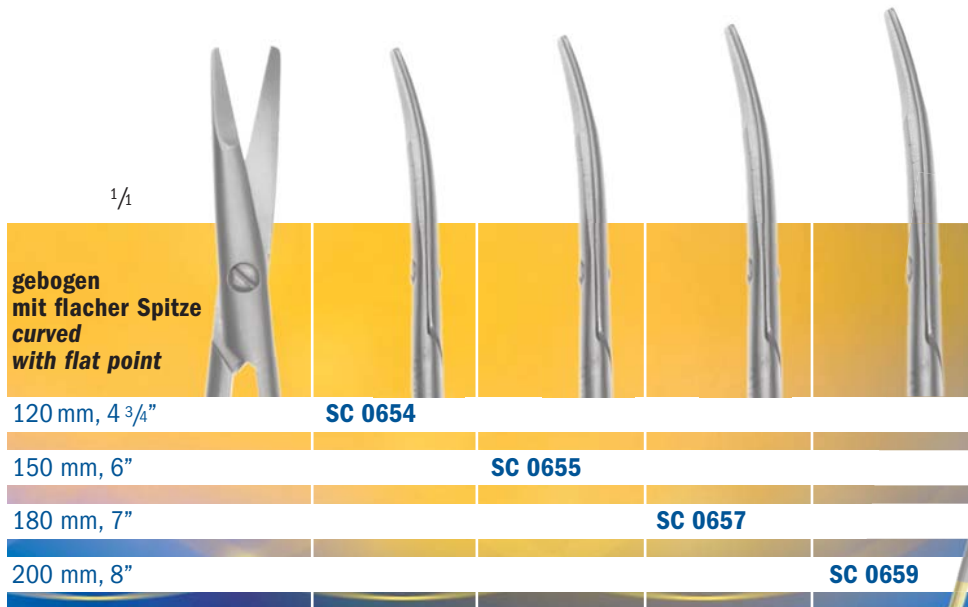

KILNER

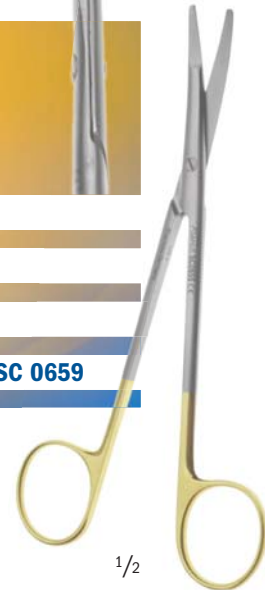

1/1

<b>gebogen, stumpf</b> <b>curved, blunt</b>		<b>SC 0721</b>
150 mm, 6"		
180 mm, 7"		<b>SC 0724</b>

**REYNOLDS**

1/2

1/1

<b>gerade</b> <b>straight</b>		<b>SC 2096</b>
150 mm, 6"		
170 mm, 6 3/4"		<b>SC 2098</b>

**MAYO-STILLE**

1/2

1/1

<b>gebogen</b> <b>curved</b>		<b>SC 2097</b>
150 mm, 6"		
170 mm, 6 3/4"		<b>SC 2099</b>

**MAYO-STILLE**

1/2

1/1

**gerade  
straight**

145 mm, 5 3/4"	<b>SC 0890</b>
170 mm, 6 3/4"	<b>SC 0892</b>
230 mm, 9"	<b>SC 0894</b>

**MAYO**

1/2

1/1

**gebogen  
curved**

145 mm, 5 3/4"	<b>SC 0891</b>
170 mm, 6 3/4"	<b>SC 0893</b>
230 mm, 9"	<b>SC 0895</b>

**MAYO**

1/2

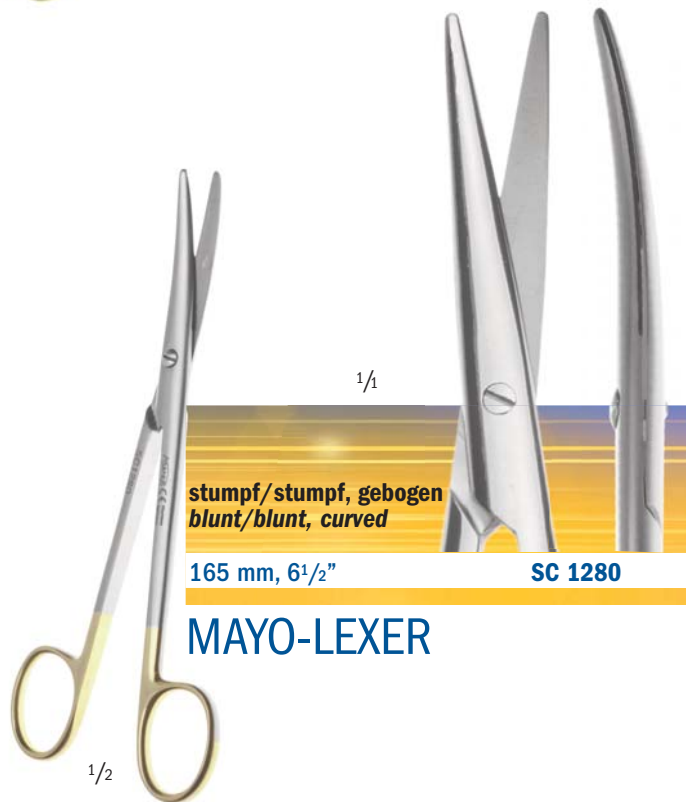

<sup>1/1</sup>

**gerade**  
extra fein abgerundete Spitzen  
**straight**  
extra delicate rounded tips

145 mm, 5 <sup>3</sup> / <sub>4</sub> "	SC 1320
180 mm, 7 "	SC 1322
205 mm, 8"	SC 1324
230 mm, 9"	SC 1326

**METZENBAUM  
ULTRA-FINO**

<sup>1/2</sup>

<sup>1/1</sup>

**gebogen**  
extra fein abgerundete Spitzen  
**curved**  
extra delicate rounded tips

145 mm, 5 <sup>3</sup> / <sub>4</sub> "	SC 1321
180 mm, 7 "	SC 1323
205 mm, 8"	SC 1325
230 mm, 9"	SC 1327
280 mm, 11"	SC 1329

**METZENBAUM  
ULTRA-FINO**

<sup>1/2</sup>



<b>gerade spitz/spitz, extra feine Spitzen straight sharp/sharp, extra delicate tips</b>	<b>SC 1312</b>
145 mm, 5 <sup>3</sup> / <sub>4</sub> "	
180 mm, 7"	<b>SC 1314</b>
230 mm, 9"	<b>SC 1318</b>

**METZENBAUM  
ULTRA-FINO**



<b>gebogen spitz/spitz, extra feine Spitzen curved sharp/sharp, extra delicate tips</b>	<b>SC 1313</b>
145 mm, 5 <sup>3</sup> / <sub>4</sub> "	
180 mm, 7"	<b>SC 1315</b>

**METZENBAUM  
ULTRA-FINO**

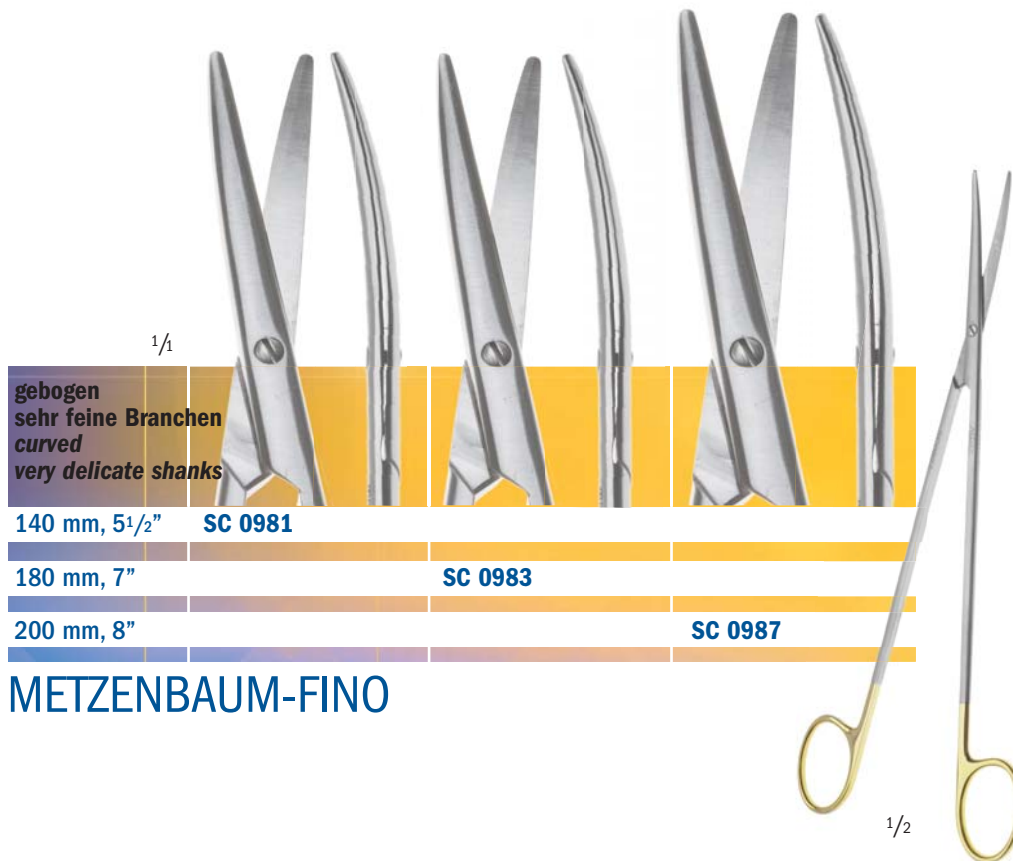
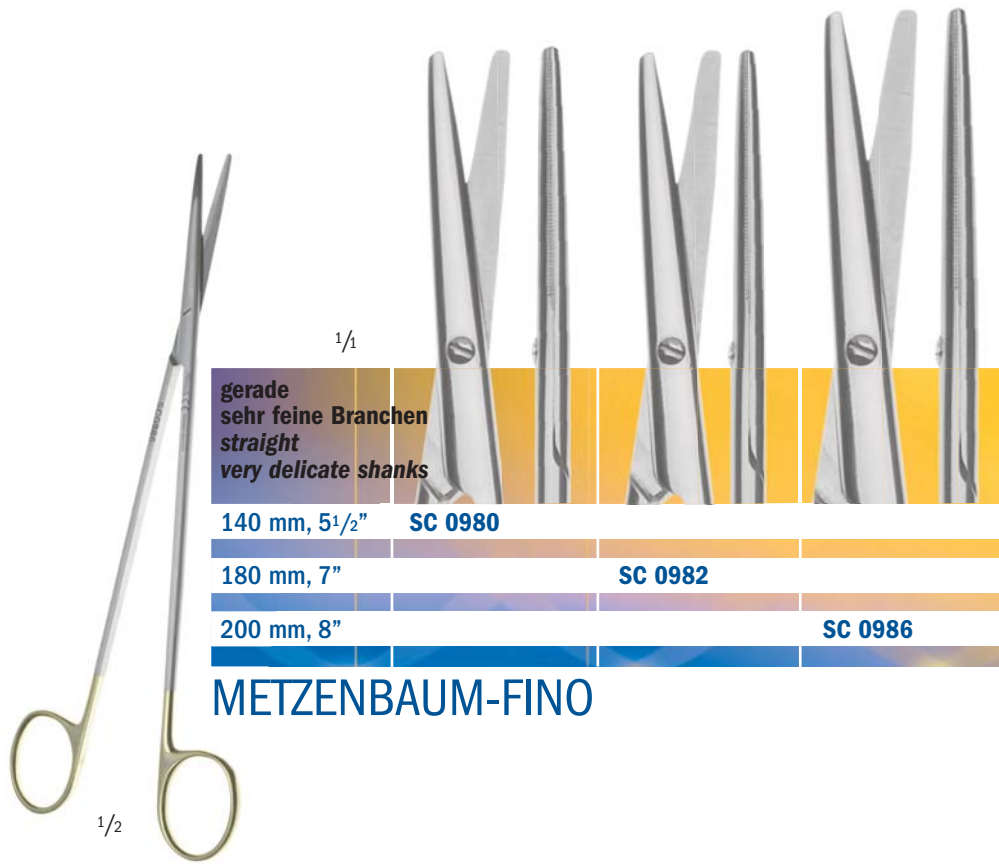

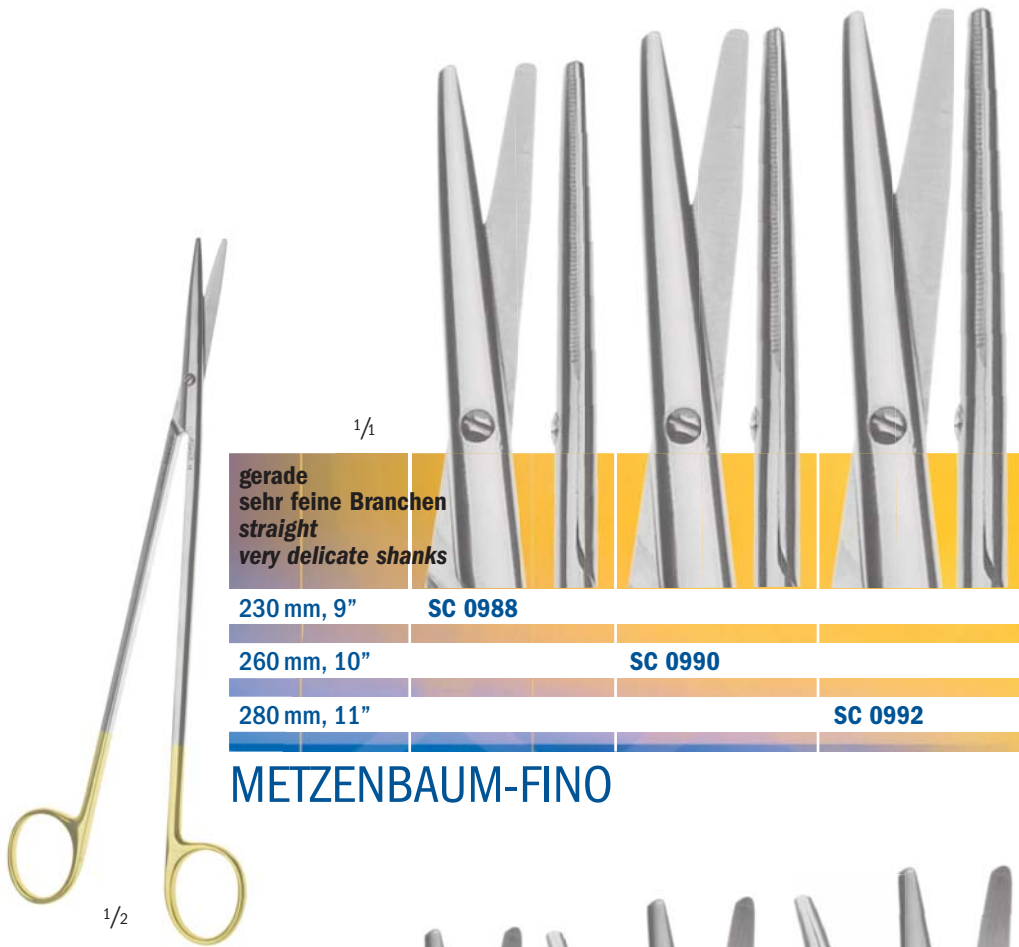

gerade  
sehr feine Branchen  
straight  
very delicate shanks

230 mm, 9"	<b>SC 0988</b>
260 mm, 10"	<b>SC 0990</b>
280 mm, 11"	<b>SC 0992</b>

**METZENBAUM-FINO**

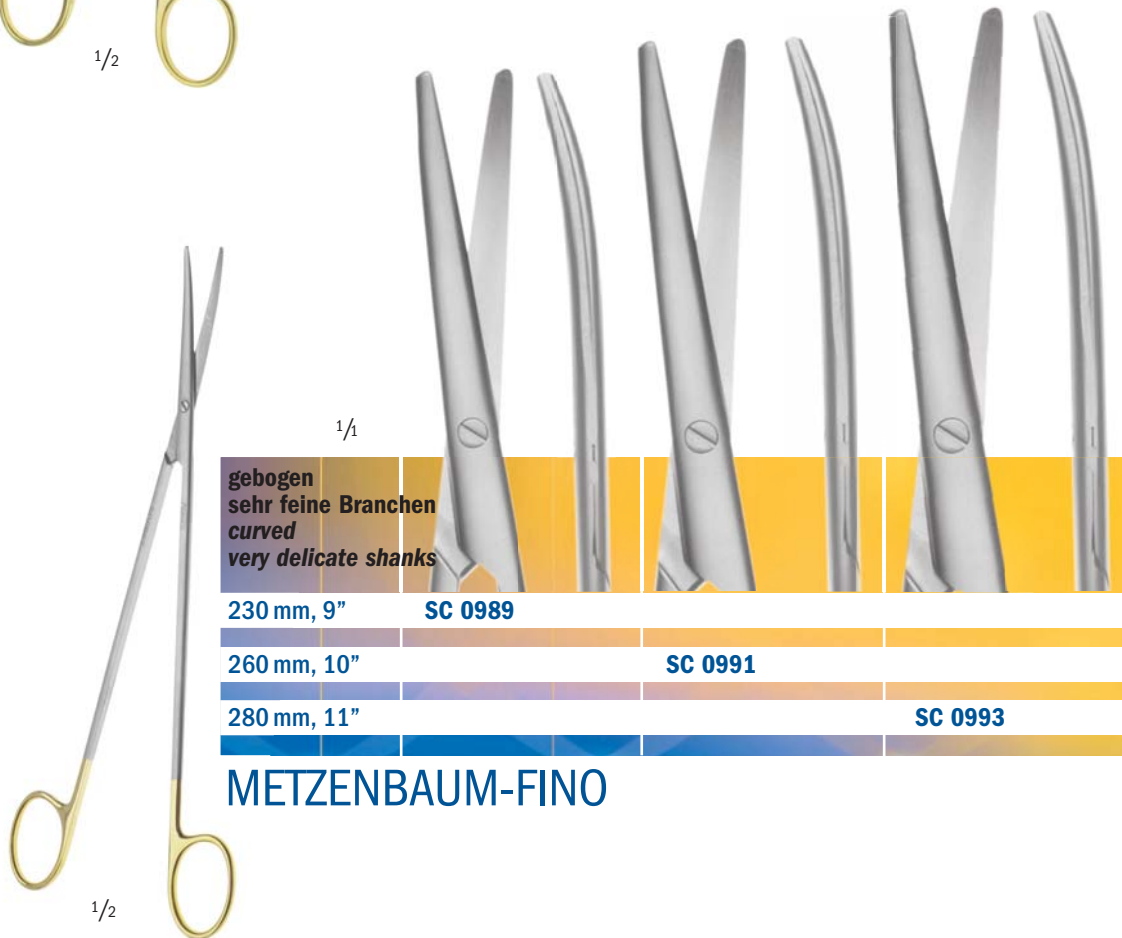

gebogen  
sehr feine Branchen  
curved  
very delicate shanks

230 mm, 9"	<b>SC 0989</b>
260 mm, 10"	<b>SC 0991</b>
280 mm, 11"	<b>SC 0993</b>

**METZENBAUM-FINO**



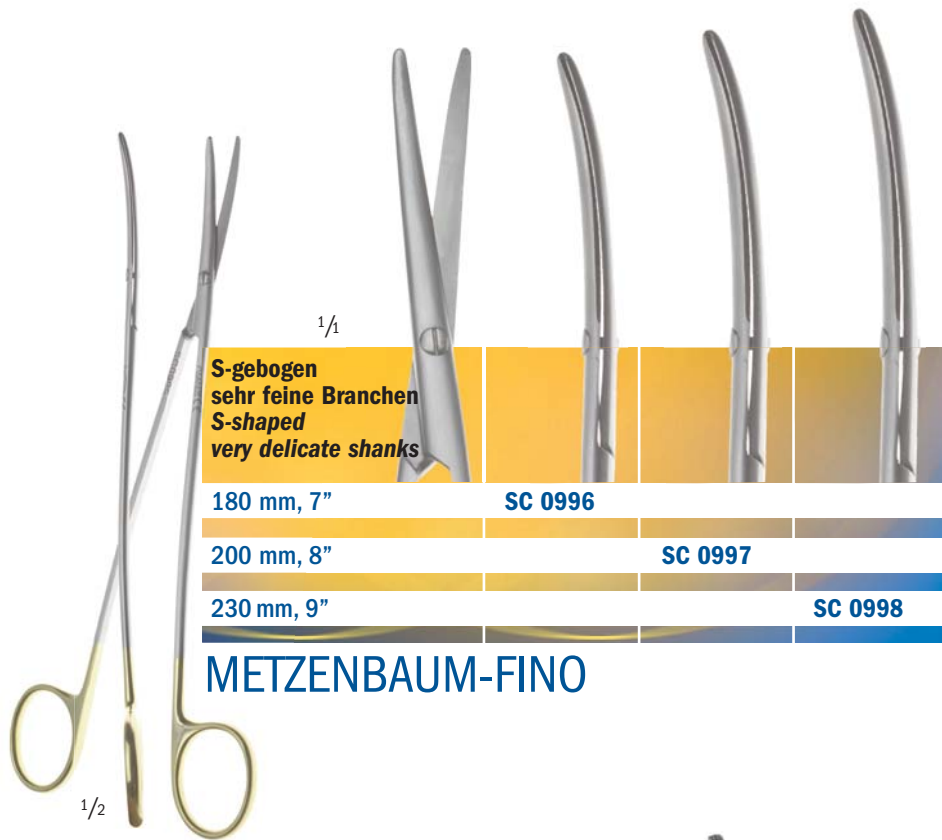

**S-gebogen**  
**sehr feine Branchen**  
**S-shaped**  
**very delicate shanks**

180 mm, 7"

SC 0996

200 mm, 8"

SC 0997

230 mm, 9"

SC 0998

**METZENBAUM-FINO**



**stumpf/stumpf**  
**blunt/blunt**

200 mm, 8"

SC 0987-1

**METZENBAUM-FINO**

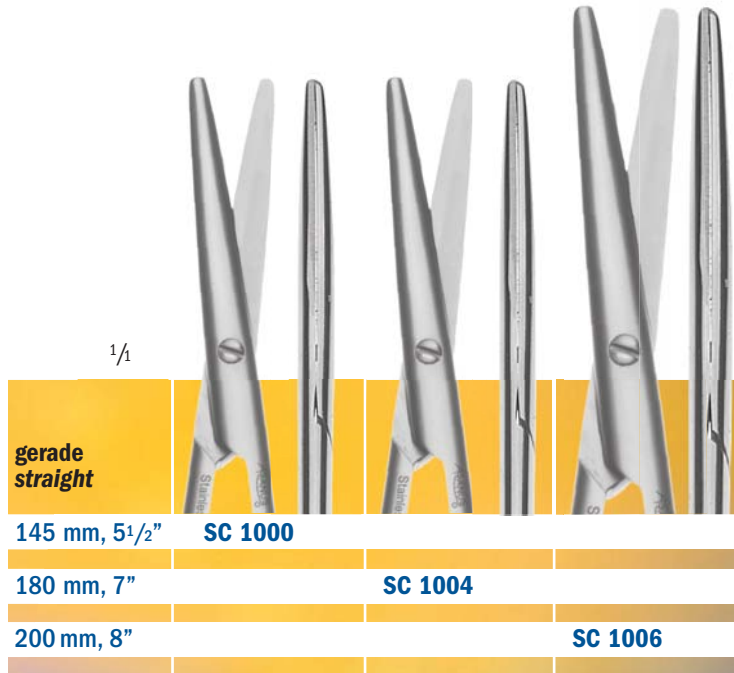

**METZENBAUM**

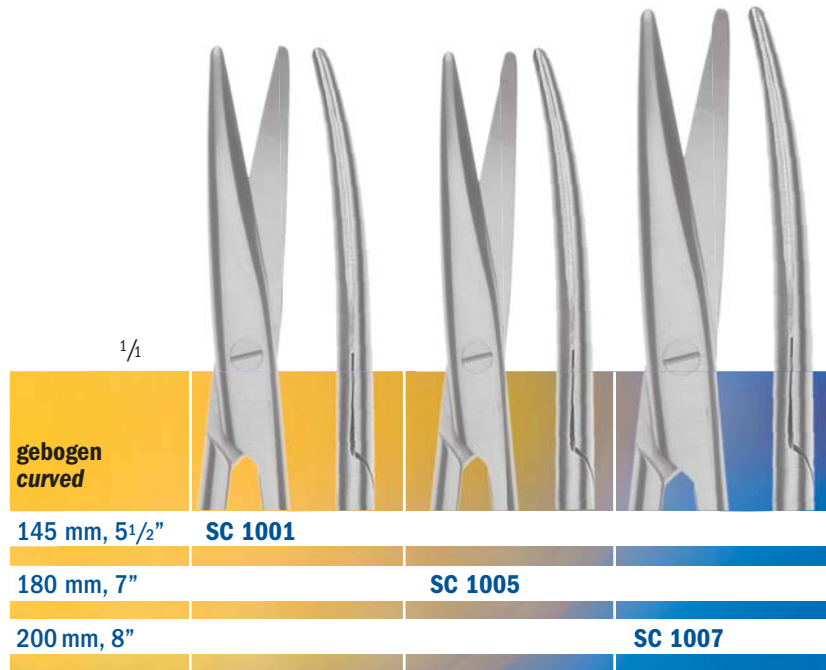

**METZENBAUM**



gerade  
straight

230 mm, 9" SC 1008

METZENBAUM

1/4

gebogen  
curved

230 mm, 9" SC 1009

260 mm, 10" SC 1011

280 mm, 11" SC 1013

300 mm, 12" SC 1015

350 mm, 14" SC 1021

METZENBAUM

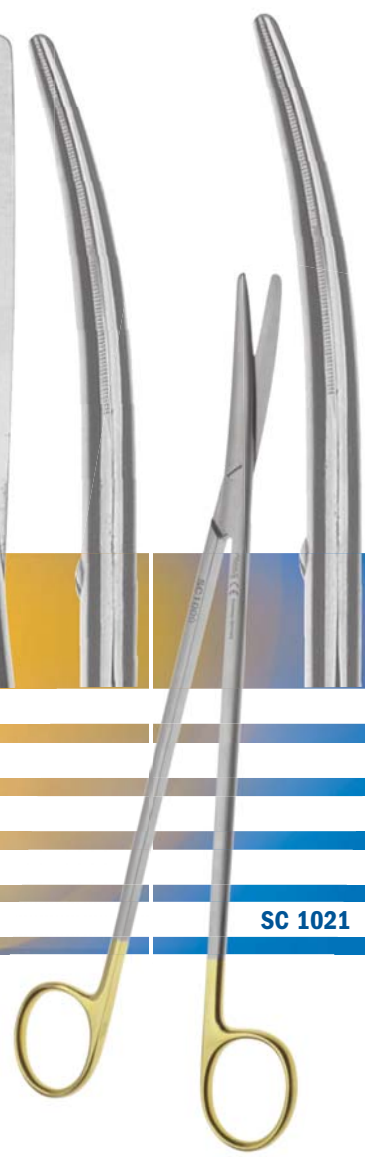

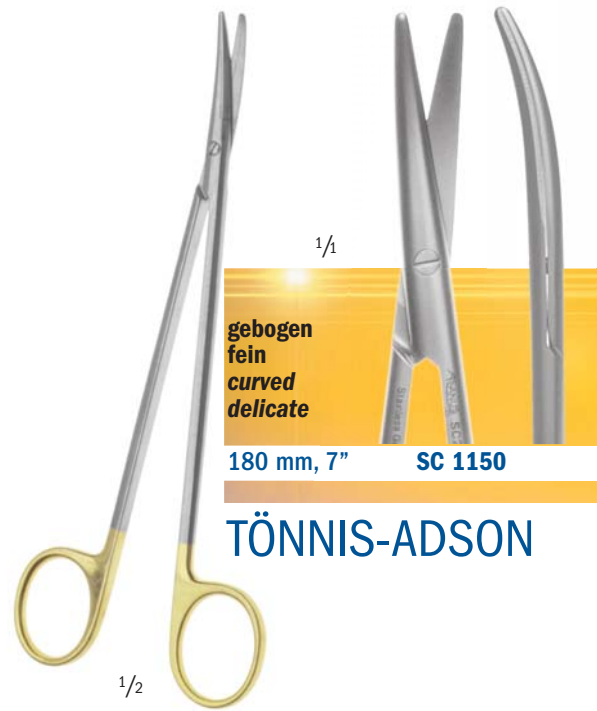

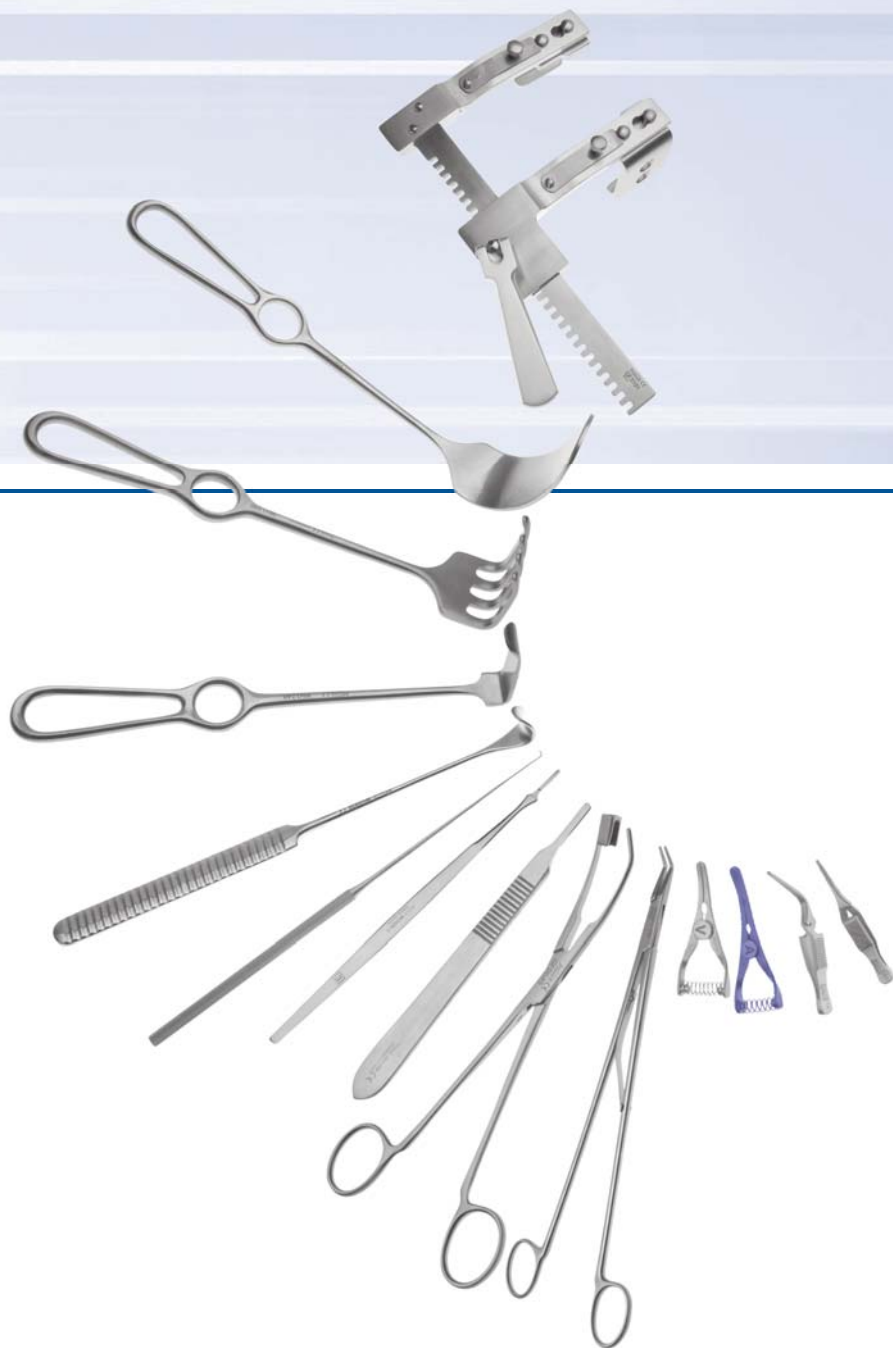

SKALPELLGRIFFE  
*SCALPEL HANDLES*

BULLDOGKLEMMEN  
*BULLDOG CLAMPS*

ANLEGEPINZETTEN  
*APPLYING FORCEPS*

WUNDHAKEN  
*WOUND RETRACTORS*

SPERRER  
*RETRACTORS*

95 mm	<b>SK 0399</b>
350 mm	<b>SK 0399-2</b>
400 mm	<b>SK 0399-1</b>
135 mm	<b>SK 0400</b>
155 mm	<b>SK 0401</b>
155 mm	<b>SK 0401K</b>
Karbon / Karbon	

**MIKRO**  
**MICRO**

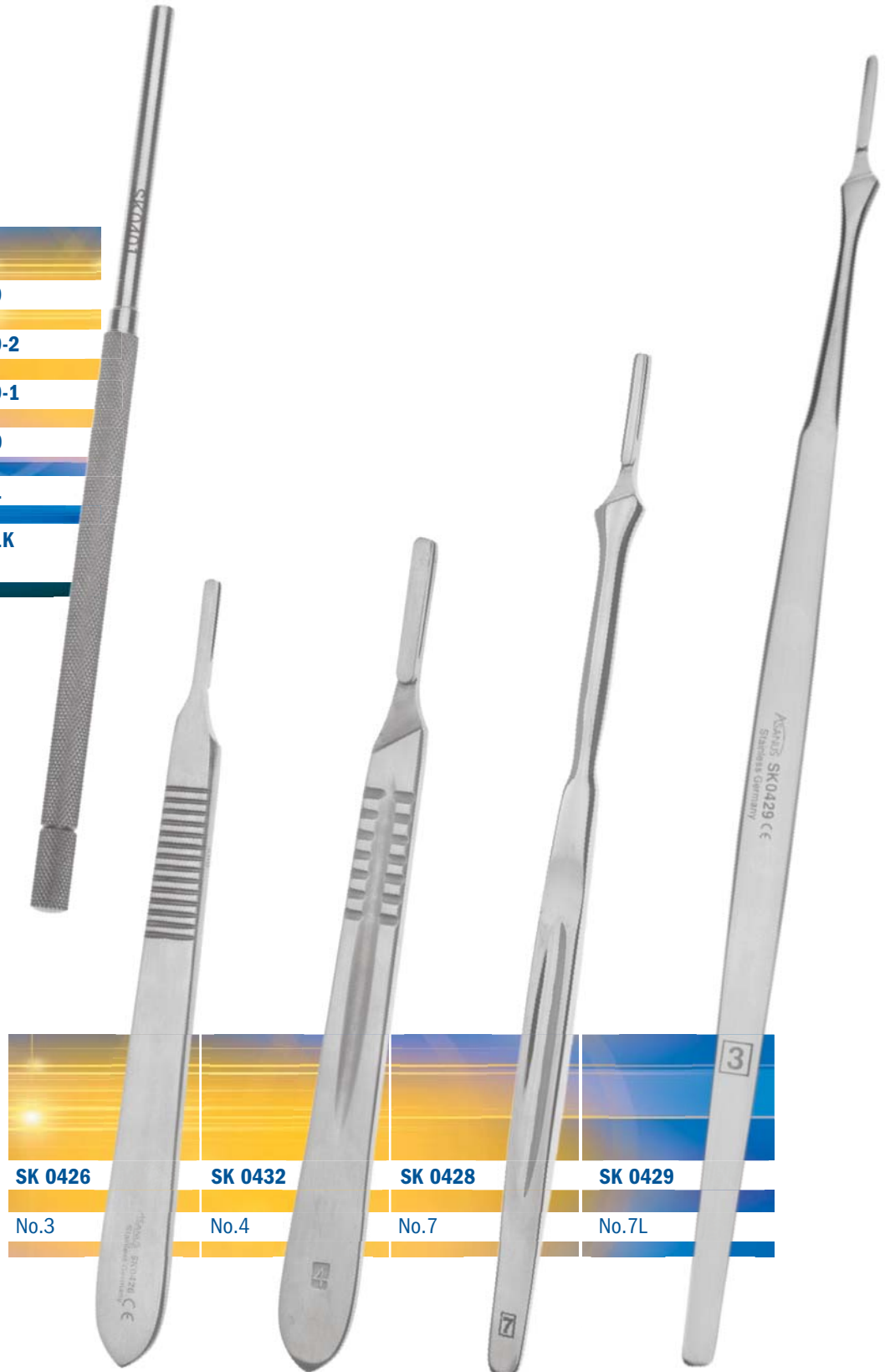

<b>SK 0426</b>	<b>SK 0432</b>	<b>SK 0428</b>	<b>SK 0429</b>
No.3	No.4	No.7	No.7L

für Klagen von  
Fig. 1-17/  
for blades fig. 1-17

für Klagen von  
Fig. 18-36/  
for blades fig. 18-36

für Klagen von  
Fig. 1-17/  
for blades fig. 1-17

für Klagen von  
Fig. 1-17/  
for blades fig. 1-17

Die Oberfläche der Griffe sind in extrem widerstandsfähigem Hochglanz bearbeitet.  
Handles are in mirror finish made. It is an excellent resistant surface against steam etc.

Fügen Sie ein **M** hinter die Artikelnummer, wenn Sie die Griffe in MATT wünschen.  
Please add **M** after the article code if you request the handles **DULL BRUSHED**.



<b>fein atraumatisch</b> <i>fine atraumatic</i>	gerade <i>straight</i>	gerade <i>straight</i>	gerade <i>straight</i>	gewinkelt <i>angled</i>	gewinkelt <i>angled</i>	gewinkelt <i>angled</i>
	<b>GF 0002</b>	<b>GF 0004</b>	<b>GF 0006</b>	<b>GF 0003</b>	<b>GF 0005</b>	<b>GF 0007</b>
Maullänge <i>jaw length</i>	10 mm	14 mm	18 mm	10 mm	14 mm	18 mm

## BULLDOGGKLEMMEN

Gewicht / *weight* 1,0 g  
Schliesskraft / *closing pressure* 30 g

<b>fein gerieft</b> <i>fine serrated</i>	gerade <i>straight</i>	gerade <i>straight</i>	gerade <i>straight</i>	gewinkelt <i>angled</i>	gewinkelt <i>angled</i>	gewinkelt <i>angled</i>
	<b>GF 0012</b> <b>GF 0012S</b>	<b>GF 0014</b> <b>GF 0014S</b>	<b>GF 0016</b> <b>GF 0016S</b>	<b>GF 0013</b> <b>GF 0013S</b>	<b>GF 0015</b> <b>GF 0015S</b>	<b>GF 0017</b> <b>GF 0017S</b>
Maullänge <i>jaw length</i>	8 mm	12 mm	16 mm	8 mm	12 mm	16 mm
Gesamtlänge <i>total length</i>	50 mm, 2"	50 mm, 2"	50 mm, 2"	45 mm, 1 <sup>1</sup> / <sub>3</sub> "	45 mm, 1 <sup>1</sup> / <sub>3</sub> "	45 mm, 1 <sup>1</sup> / <sub>3</sub> "

<b>glatt</b> <i>smooth</i>	gerade <i>straight</i>	gewinkelt <i>angled</i>
	<b>GF 0009</b>	<b>GF 0011</b>
Maullänge <i>jaw length</i>	8 mm	12 mm
Gesamtlänge <i>total length</i>	50 mm, 2"	50 mm, 2"

## DIETHRICH

Gewicht / *weight* 3,0 g  
Schliesskraft / *closing pressure* 80 g  
S = Schliesskraft / *closing pressure* 180 g



	gebogen <i>curved</i>
48mm	<b>GF 0913</b>

## DIETHRICH DE BAKHEY

<b>Bulldogklemmen</b> <b>Bulldog clamps</b> <b>Pressure 30g</b>	gewinkelt angled Stahl steel	gewinkelt angled Titan titanium	gerade straight Stahl steel	gerade straight Titan titanium	gebogen curved Titan titanium
10 mm	<b>GF 0019</b>	<b>GF 0019T</b>	<b>GF 0022</b>	<b>GF 0022T</b>	
15 mm	<b>GF 0020</b>	<b>GF 0020T</b>	<b>GF 0023</b>	<b>GF 0023T</b>	<b>GF 0030T</b>
20 mm	<b>GF 0021</b>	<b>GF 0021T</b>	<b>GF 0024</b>	<b>GF 0024T</b>	

**SOFTGRIP MICRO 30g**

stark gebogen strongly curved	45° gewinkelt angled	25° gewinkelt angled	90° gewinkelt angled	gebogen curved	gerade straight
<b>GF 0651</b>	<b>GF 0652</b>	<b>GF 0653</b>	<b>GF 0654</b>	<b>GF 0655</b>	<b>GF 0656</b>

**MINI-BULLDOGKLEMMEN**

gerade straight	gebogen curved	60° gewinkelt 60° angled
57 mm <b>GF 0904</b>	58 mm <b>GF 0905</b>	58 mm <b>GF 0906</b>

60° gewinkelt Innen-Ø 4,6 mm, 60° angled Inside-Ø 4,6 mm,	<b>TITAN</b> <b>TITANIUM</b>
86 mm, 3 1/2"	<b>GF 8610</b>

**BULLDOG SHUNT  
KLEMME**



**DE BAKEY**





gerade straight	V = Vena	A = Arteria	V = Vena	A = Arteria	V = Vena	A = Arteria	V = Vena	A = Arteria
	<b>GF 0701</b>	<b>GF 0711</b>	<b>GF 0702</b>	<b>GF 0712</b>	<b>GF 0703</b>	<b>GF 0713</b>	<b>GF 0704</b>	<b>GF 0714</b>
Gesamtlänge Total length	30 mm	30 mm	35 mm	35 mm	40 mm	40 mm	50 mm	50 mm
Maullänge Jaw length	9 mm	9 mm	13 mm	13 mm	14 mm	14 mm	23 mm	23 mm
Schließdruck Occlusion pressure	110+10gr.	220+10gr.	110+10gr.	220+10gr.	110+10gr.	220+10gr.	110+10gr.	220+10gr.
Gewicht Weight	1 gr.	1 gr.	1 gr.	1 gr.	1 gr.	1 gr.	1,5 gr.	1,5 gr.



gebogen curved	V = Vena	A = Arteria	V = Vena	A = Arteria	V = Vena	A = Arteria	V = Vena	A = Arteria
	<b>GF 0731</b>	<b>GF 0741</b>	<b>GF 0732</b>	<b>GF 0742</b>	<b>GF 0733</b>	<b>GF 0743</b>	<b>GF 0734</b>	<b>GF 0744</b>
Gesamtlänge Total length	30 mm	30 mm	35 mm	35 mm	40 mm	40 mm	48 mm	48 mm
Maullänge Jaw length	9 mm	9 mm	13 mm	13 mm	14 mm	14 mm	22 mm	22 mm
Schließdruck Occlusion pressure	110+10gr.	220+10gr.	110+10gr.	220+10gr.	110+10gr.	220+10gr.	110+10gr.	220+10gr.
Gewicht Weight	1 gr.	1 gr.	1 gr.	1 gr.	1 gr.	1 gr.	1,5 gr.	1,5 gr.



stark gebogen strongly curved	V = Vena	A = Arteria	V = Vena	A = Arteria	V = Vena	A = Arteria	V = Vena	A = Arteria
	<b>GF 0747</b>	<b>GF 0749</b>	<b>GF 0752</b>	<b>GF 0762</b>	<b>GF 0753</b>	<b>GF 0763</b>	<b>GF 0754</b>	<b>GF 0764</b>
Gesamtlänge Total length	30 mm	30 mm	35 mm	35 mm	40 mm	40 mm	50 mm	50 mm
Maullänge Jaw length	9 mm	9 mm	13 mm	13 mm	14 mm	14 mm	21 mm	21 mm
Schließdruck Occlusion pressure	110+10gr.	220+10gr.	110+10gr.	220+10gr.	110+10gr.	220+10gr.	110+10gr.	220+10gr.
Gewicht Weight	1 gr.	1 gr.	1 gr.	1 gr.	1 gr.	1 gr.	1,5 gr.	1,5 gr.

<b>Carotis</b> <b>Carotid</b>	links gebogen <i>bent to left</i>	rechts gebogen <i>bent to right</i>
110 mm, 4 <sup>3</sup> / <sub>8</sub> "	<b>GF 0897</b>	<b>GF 0898</b>

**GREGORY**



MINI, fein <i>MINI, delicate</i>	<b>GF 0700</b>	<b>GF 0710</b>	<b>GF 0720</b>
Mauillänge <i>Jaw length</i>	27 mm	38 mm	50 mm
Gesamtlänge <i>Total length</i>	48 mm	73 mm	95 mm

atraumatic <i>atraumatic</i>	<b>GF 0690</b>
Mauillänge <i>Jaw length</i>	27 mm
Gesamtlänge <i>Total length</i>	50 mm

**DE BAKEY**

gewinkelt <i>angled</i>	<b>GF 0970</b>
Mauillänge <i>Jaw length</i>	27 mm
Gesamtlänge <i>Total length</i>	57 mm

**DE BAKEY SATINSKY**



<b>De Bakey</b>	gerade <i>straight</i>	gerade <i>straight</i>	gerade <i>straight</i>	gerade <i>straight</i>
<b>Stahl/Steel Titanium</b>	<b>GF 0890 GF 8410</b>	<b>GF 0910 GF 8412</b>	<b>GF 0930 GF 8414</b>	<b>GF 0950 GF 8416</b>
Maullänge <i>jaw length</i>	20 mm	30 mm	46 mm	68 mm
Gesamtlänge <i>total length</i>	75 mm	85 mm	110 mm	120 mm



<b>De Bakey</b>	gebogen <i>curved</i>	gebogen <i>curved</i>	gebogen <i>curved</i>	gebogen <i>curved</i>
<b>Stahl/Steel Titanium</b>	<b>GF 0900 GF 8411</b>	<b>GF 0920 GF 8413</b>	<b>GF 0940 GF 8415</b>	<b>GF 0960 GF 8415</b>
Maullänge <i>jaw length</i>	18 mm	27 mm	39 mm	53 mm
Gesamtlänge <i>total length</i>	75 mm	80 mm	100 mm	115 mm



<b>De Bakey</b>	gerade <i>straight</i>	gerade <i>straight</i>	gerade <i>straight</i>	gerade <i>straight</i>
<b>Stahl/Steel</b>	<b>GF 0975</b>	<b>GF 0980</b>	<b>GF 1000</b>	<b>GF 1020</b>
Maullänge <i>jaw length</i>	19 mm	28 mm	41 mm	60 mm
Gesamtlänge <i>total length</i>	60 mm	70 mm	90 mm	110 mm

GLOVER



<b>De Bakey</b>	gebogen <i>curved</i>	gebogen <i>curved</i>	gebogen <i>curved</i>	gebogen <i>curved</i>
<b>Stahl/Steel</b>	<b>GF 0985</b>	<b>GF 0990</b>	<b>GF 1010</b>	<b>GF 1030</b>
Maullänge <i>jaw length</i>	18 mm	26 mm	38 mm	57 mm
Gesamtlänge <i>total length</i>	55 mm	65 mm	85 mm	105 mm

GLOVER

Anlegepinzette  
applying forcep

200 mm, 8" **GF 0645**

**SCHWARTZ**



	gerade straight	25°	45°
25 mm	<b>GF 0646</b>	<b>GF 0647</b>	<b>GF 0648</b>

**SCHWARTZ**

Gewicht / weight 0,5 g  
Schliesskraft / closing pressure 250 g

Anlegepinzette  
applying forcep

240 mm, 9 1/2" **KL 2070**

**JOHNS HOPKINS**



38 mm	<b>KL 2000</b>
51 mm	<b>KL 2010</b>
57 mm	<b>KL 2020</b>
63 mm	<b>KL 2030</b>
70 mm	<b>KL 2040</b>
80 mm	<b>KL 2050</b>
90 mm	<b>KL 2060</b>

**JOHNS HOPKINS**

Gewicht / weight 7,5 g  
Schliesskraft / closing pressure 500 g

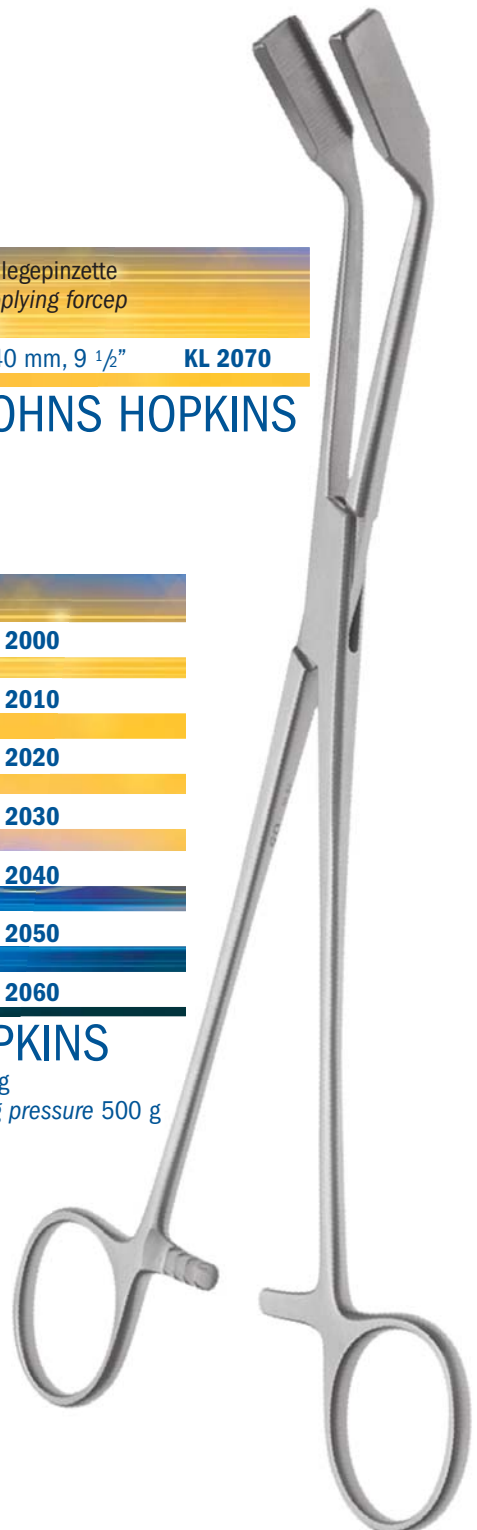

# Bulldogklemmen, Anlegepinzetten

## Bulldog Clamps, Applying Forceps

CL

CLIP-APPLIKATOREN PASSEND ZU CLIPSE VON ETHICON,  
 RESTERILISIERBAR  
 LIGATUR CLIP-APPLICATORS FOR CLIPS OF ETHICON,  
 RSTERILIZATION

	Farbe color	Clipgröße clip size
185 mm, 7 1/4" <b>CL 0107</b>	blau/blue	klein/small
280 mm, 11" <b>CL 0090</b>	blau/blue	klein/small

	Farbe color	Clipgröße clip size
185 mm, 7 1/4" <b>CL 0207</b>	silber/silver	mittel/medium
280 mm, 11" <b>CL 0210</b>	silber/silver	mittel/medium
280 mm, 11" <b>CL 0220</b> mit 45° aufgewinkeltem Schaft/ with 45° angled shaft	silber/silver	mittel/medium

	Farbe color	Clipgröße clip size
185 mm, 7 1/4" <b>CL 0307</b>	grün/green	mittelgroß/medium size
280 mm, 11" <b>CL 0310</b>	grün/green	mittelgroß/medium size
280 mm, 11" <b>CL 0320</b> mit 45° aufgewinkeltem Schaft/ with 45° angled shaft	grün/green	mittelgroß/medium size

	Farbe color	Clipgröße clip size
185 mm, 7 1/4" <b>CL 0410</b>	gelb/yellow	groß/large
280 mm, 11" <b>CL 0420</b> mit 45° aufgewinkeltem Schaft/ with 45° angled shaft	gelb/yellow	groß/large

Bitte fragen Sie uns separat wegen Clipse an.  
 Please ask us separatly for clipse.

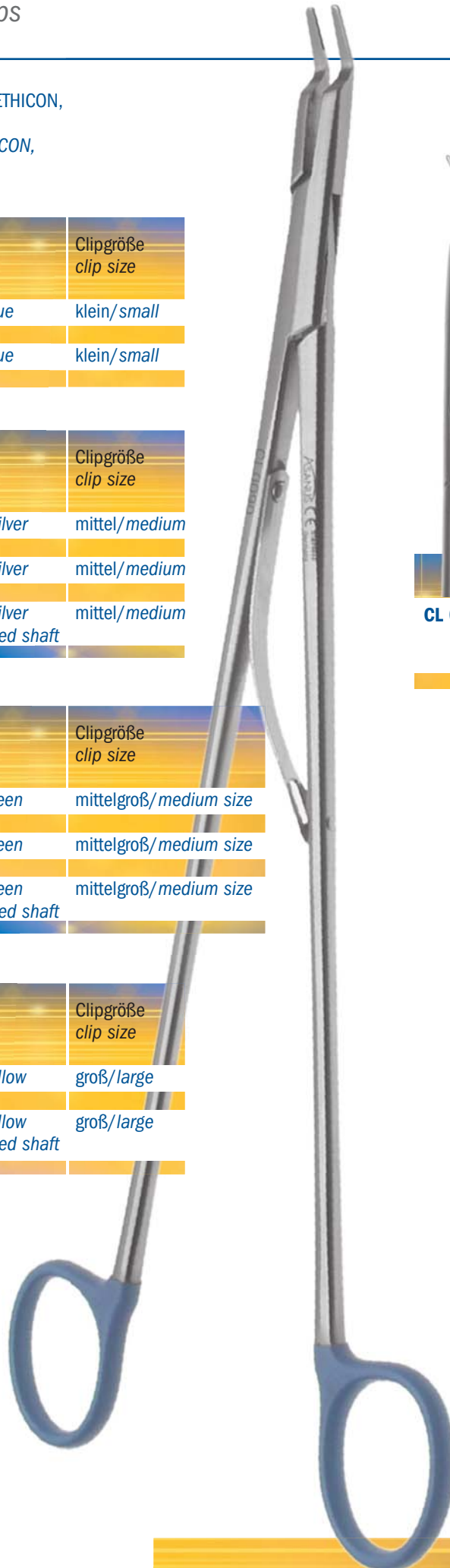

CL 0090

CL 0220

45° aufgewinkelt  
 45° angled

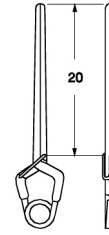
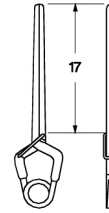
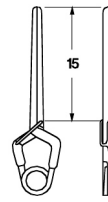
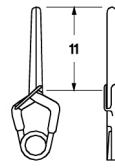
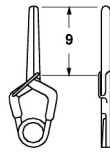
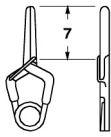

Titanium	YA 1125T	YA 1155T	YA 1180T	YA 1205T	YA 1230T	YA 1225T
Stahl/Steel	YA 1125	YA 1155	YA 1180	YA 1205	YA 1230	YA 1225
Öffnung max. opening	6,2 mm	7,0 mm	7,8 mm	9,2 mm	10,6 mm	11,4 mm
Druck Force	110 gms	90 gms	90 gms	90 gms	90 gms	110 gms

**STANDARD** für temporären Verschuß  
for temporary closure

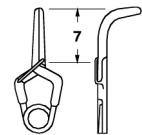
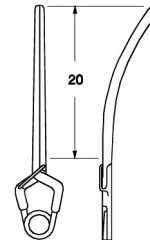
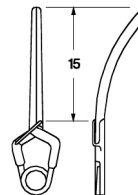
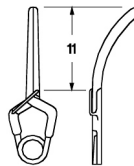
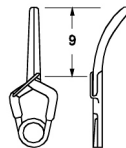
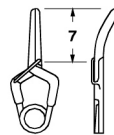
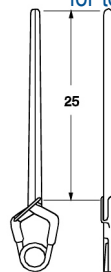

Titanium	YA 1226T	YA 1130T	YA 1160T	YA 1190T	YA 1210T	YA 1211T	YA 1135T
Stahl/Steel	YA 1226	YA 1130	YA 1160	YA 1190	YA 1210	YA 1211	YA 1135
Öffnung max. opening	13,3 mm	6,0 mm	6,8 mm	7,5 mm	8,7 mm	11,0 mm	5,5 mm
Druck Force	110 gms	110 gms	90 gms	110 gms	90 gms	90 gms	110 gms

**STANDARD** für temporären Verschuß  
for temporary closure

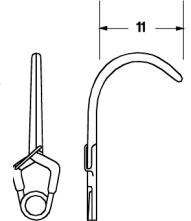
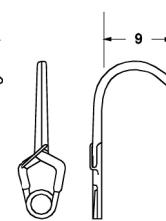
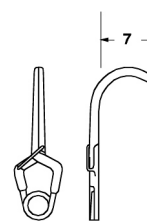
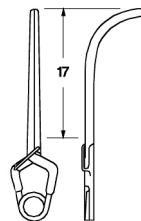
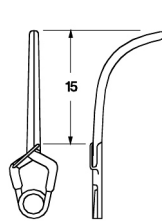
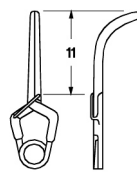
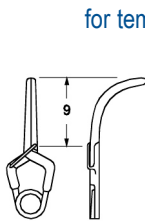

Titanium	YA 1165T	YA 1200T	YA 1215T	YA 1216T	YA 1275T	YA 1280T	YA 1185T
Stahl/Steel	YA 1165	YA 1200	YA 1215	YA 1216	YA 1275	YA 1280	YA 1185
Öffnung max. opening	6,1 mm	6,5 mm	7,4 mm	9,9 mm	5,4 mm	5,8 mm	6,2 mm
Druck Force	110 gms	110 gms	110 gms	90 gms	110 gms	110 gms	180 gms

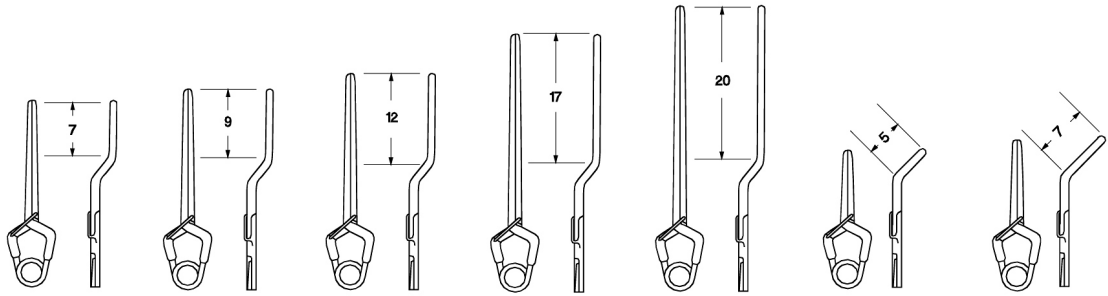

Titanium	YA 1150T	YA 1170T	YA 1175T	YA 1176T	YA 1177T	YA 1015T	YA 1020T
Stahl/Steel	YA 1150	YA 1170	YA 1175	YA 1176	YA 1177	YA 1015	YA 1020
Öffnung max.opening	7,9 mm	8,7 mm	10,2 mm	11,9 mm	13,07 mm	6,2 mm	6,5 mm
Druck Force	90 gms	90 gms	90 gms	90 gms	90 gms	110 gms	110 gms

**STANDARD** für temporären Verschluss  
for temporary closure

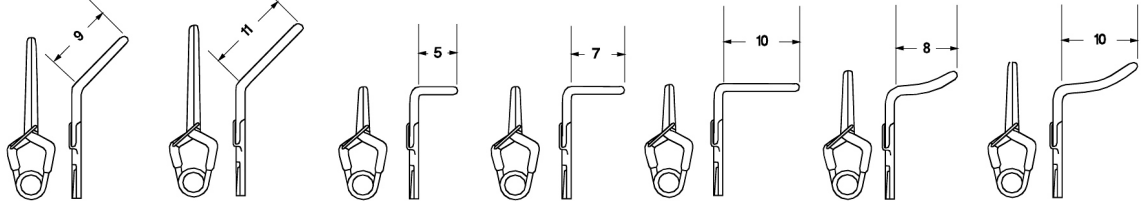

Titanium	YA 1025T	YA 1195T	YA 1260T	YA 1265T	YA 1270T	YA 1305T	YA 1310T
Stahl/Steel	YA 1025	YA 1195	YA 1260	YA 1265	YA 1270	YA 1305	YA 1310
Öffnung max.opening	7,8 mm	8,4 mm	5,6 mm	5,6 mm	5,6 mm	5,4 mm	5,6 mm
Druck Force	110 gms	110 gms	130 gms	130 gms	130 gms	130 gms	130 gms

**STANDARD** für temporären Verschluss  
for temporary closure

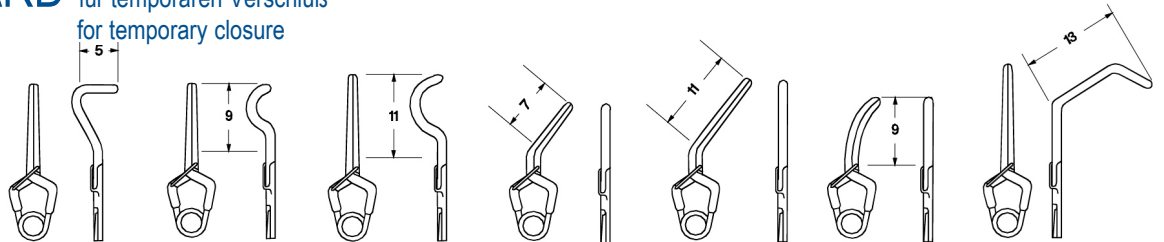

Titanium	YA 1290T	YA 1295T	YA 1300T	YA 1140T	YA 1185T	YA 1145T	YA 1148T
Stahl/Steel	YA 1290	YA 1295	YA 1300	YA 1140	YA 1185	YA 1145	YA 1148
Öffnung max.opening	7,2 mm	7,2 mm	8,2 mm	5,7 mm	8,0 mm	6,2 mm	7,5 mm
Druck Force	90 gms	90 gms	90 gms	90 gms	90 gms	90 gms	90 gms

**STANDARD** für temporären Verschluss  
for temporary closure

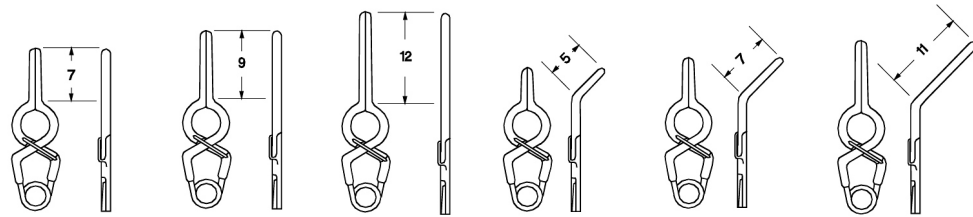

Titanium	YA 1016T	YA 1017T	YA 1018T	YA 1014T	YA 1019T	YA 1024T
Stahl/Steel	YA 1016	YA 1017	YA 1018	YA 1014	YA 1019	YA 1024
Öffnung max.opening	7,4 mm	8,4 mm	9,6 mm	5,8 mm	6,5 mm	7,2 mm
Druck Force	110 gms	110 gms	90 gms	110 gms	110 gms	110 gms

**STANDARD** für temporären Verschuß, gefenstert 3,5 mm  
for temporary closure, fenestrated 3,5 mm

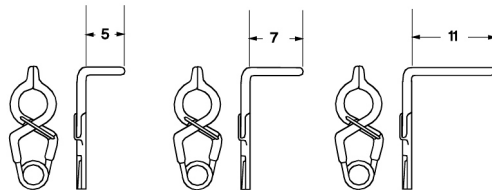

Titanium	YA 1026T	YA 1027T	YA 1028T
Stahl/Steel	YA 1026	YA 1027	YA 1028
Öffnung max.opening	4,9 mm	4,9 mm	4,9 mm
Druck Force	110 gms	110 gms	110 gms

**STANDARD** für temporären Verschuß, gefenstert 3,5 mm  
for temporary closure, fenestrated 3,5 mm



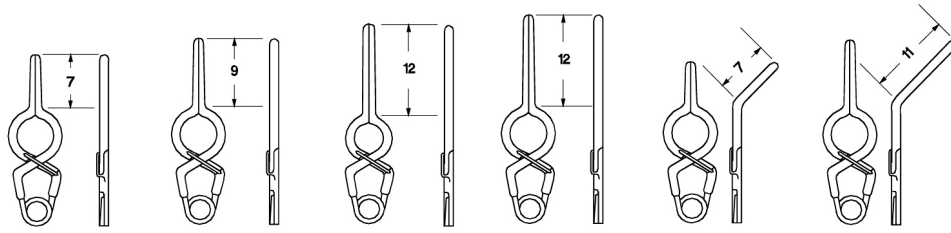

Titanium Stahl/Steel	YA 0191T YA 0191	YA 0211T YA 0211	YA 1018T YA 1018	YA 0231T YA 0231	YA 0216T YA 0216	YA 0236T YA 0236
Öffnung max. opening	7,9 mm	9,1 mm	10,3 mm	6,5 mm	7,2 mm	7,8 mm
Druck Force	110 gms	110 gms	90 gms	110 gms	110 gms	110 gms

**STANDARD** für temporären Verschuß, gefenestert 5,0 mm  
for temporary closure, fenestrated 5,0 mm

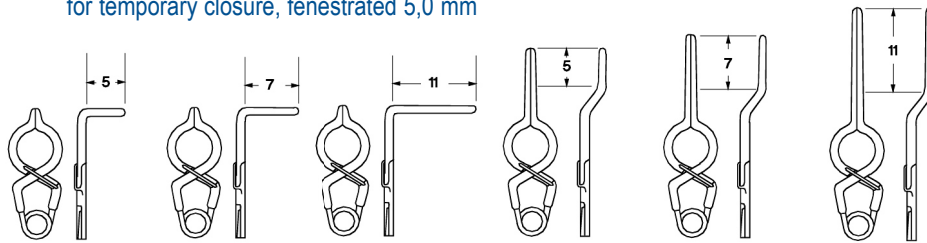

Titanium Stahl/Steel	YA 0206T YA 0206	YA 0226T YA 0226	YA 0246T YA 0246	YA 0251T YA 0251	YA 0252T YA 0252	YA 0253T YA 0253
Öffnung max. opening	5,5 mm	5,5 mm	5,5 mm	7,9 mm	8,8 mm	10,0 mm
Druck Force	110 gms	110 gms	90 gms	90 gms	90 gms	90 gms

**STANDARD** für temporären Verschuß, gefenestert 5,0 mm  
for temporary closure, fenestrated 5,0 mm

MEMORYEFFECT findet seine natürliche Form wieder durch den Wasch- und Desinfektionsprozeß.  
MEMORY EFFECT returns to its natural form after washing and disinfection process via temperature.



Standard-Clipse  
bajonett, mit Sperre  
Standard clipse  
bajonett, with ratchet

170 mm, 6 3/4" YA 1350

210 mm, 8 1/2" YA 1355

230 mm, 9 1/2" YA 1360

**YASARGIL**

Standard, flexibel  
Arbeitslänge 90 mm  
Standard, flexible  
working length 90 mm

240 mm, 9 1/2" YA 1367

Nitinol Anlegezange  
Nitinol Applying forceps



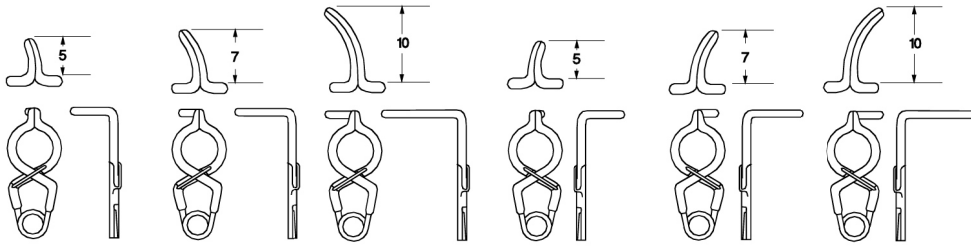

Titanium	YA 0536T	YA 0541T	YA 0546T	YA 0551T	YA 0556T	YA 0561T
Stahl/Steel	YA 0536	YA 0541	YA 0546	YA 0551	YA 0556	YA 0561
Öffnung max.opening	5,8 mm	5,8 mm	5,8 mm	5,85 mm	5,8 mm	5,8 mm
Druck Force	110 gms	110 gms	110 gms	110 gms	110 gms	110 gms

**STANDARD** für temporären Verschuß, gefenestert 5,0 mm  
for temporary closure, fenestrated 5,0 mm

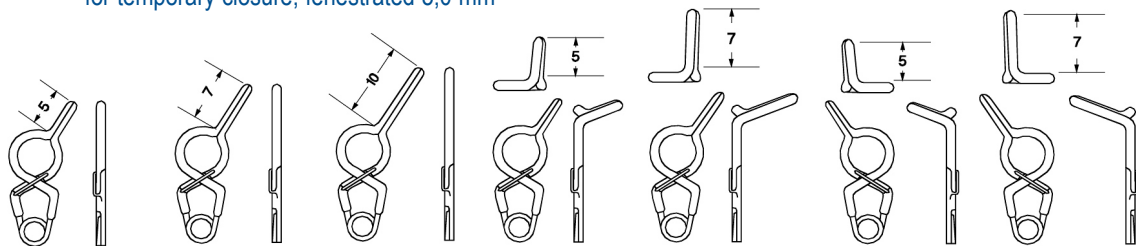

Titanium	YA 0706T	YA 0711T	YA 0716T	YA 0721T	YA 0726T	YA 0731T	YA 0736T
Stahl/Steel	YA 0706	YA 0711	YA 0716	YA 0721	YA 0726	YA 0731	YA 0736
Öffnung max.opening	7,0 mm	7,8 mm	8,8 mm	5,8 mm	6,2 mm	5,8 mm	6,2 mm
Druck Force	110 gms	110 gms	110 gms	110 gms	110 gms	110 gms	110 gms

**STANDARD** für temporären Verschuß, gefenestert 5,0 mm  
for temporary closure, fenestrated 5,0 mm

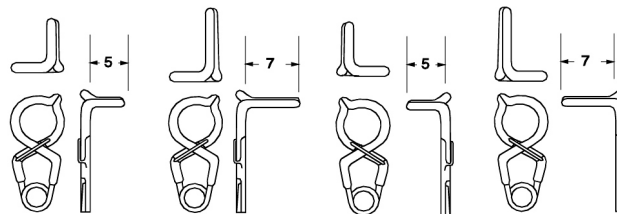

Titanium	YA 0741T	YA 0746T	YA 0751T	YA 0756T
Stahl/Steel	YA 0741	YA 0746	YA 0751	YA 0756
Öffnung max.opening	5,6 mm	5,6 mm	5,6 mm	5,6 mm
Druck Force	110 gms	110 gms	110 gms	110 gms

**STANDARD** für temporären Verschuß, gefenestert 5,0 mm  
for temporary closure, fenestrated 5,0 mm

Einzelklemme Ø Gefäß Single clamp Ø vessel	Länge Clips length clips	Vene Vein	Vene Vein	Arterie Artery	Arterie Artery
Ø 0,4 - 1,0 mm	8 mm	<b>MN 6000</b>	<b>MN 6002</b>	<b>MN 6001</b>	<b>MN 6003</b>
Ø 0,6 - 1,5 mm	11 mm	<b>MN 6010</b>	<b>MN 6012</b>	<b>MN 6011</b>	<b>MN 6013</b>
Ø 1,0 - 2,25 mm	17 mm	<b>MN 6020</b>	<b>MN 6022</b>	<b>MN 6021</b>	<b>MN 6023</b>
Ø 1,5 - 3,5 mm	25 mm		<b>MN 6030</b>		<b>MN 6031</b>
Ø 2,0 - 5,0 mm	36 mm		<b>MN 6034</b>		<b>MN 6035</b>

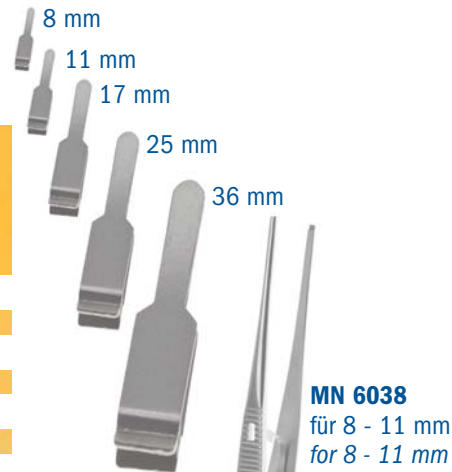

**Klemmenanlegepinzetten  
 Clamp applying forceps**

140 mm, 5 1/2" **MN 6038**

145 mm, 5 3/4" **MN 6040**

**ACLAND**

Approximator Ø Gefäß Approximator Ø vessel	Länge Clips length clips	Vene Vein	Vene Vein	Arterie Artery	Arterie Artery
Ø 0,4 - 1,0 mm	8 mm	<b>MN 6004</b>	<b>MN 6006</b>	<b>MN 6005</b>	<b>MN 6007</b>
Ø 0,6 - 1,5 mm	11 mm	<b>MN 6014</b>	<b>MN 6016</b>	<b>MN 6015</b>	<b>MN 6017</b>
Ø 1,0 - 2,25 mm	17 mm	<b>MN 6024</b>	<b>MN 6026</b>	<b>MN 6025</b>	<b>MN 6027</b>

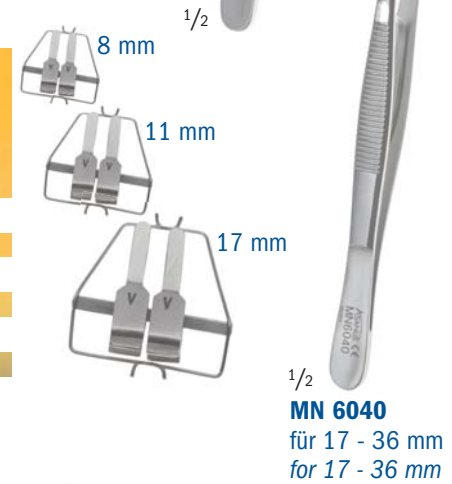

**ACLAND**

Doppelklemme Ø Gefäß Double clamp Ø vessel	Länge Clips length clips	Vene Vein	Arterie Artery
Ø 0,4 - 1,0 mm	8 mm	<b>MN 6008</b>	<b>MN 6009</b>
Ø 0,6 - 1,5 mm	11 mm	<b>MN 6018</b>	<b>MN 6019</b>
Ø 1,0 - 2,25 mm	17 mm	<b>MN 6028</b>	<b>MN 6029</b>
Ø 1,5 - 3,5 mm	25 mm	<b>MN 6032</b>	<b>MN 6033</b>
Ø 2,0 - 5,0 mm	36 mm	<b>MN 6036</b>	<b>MN 6035</b>

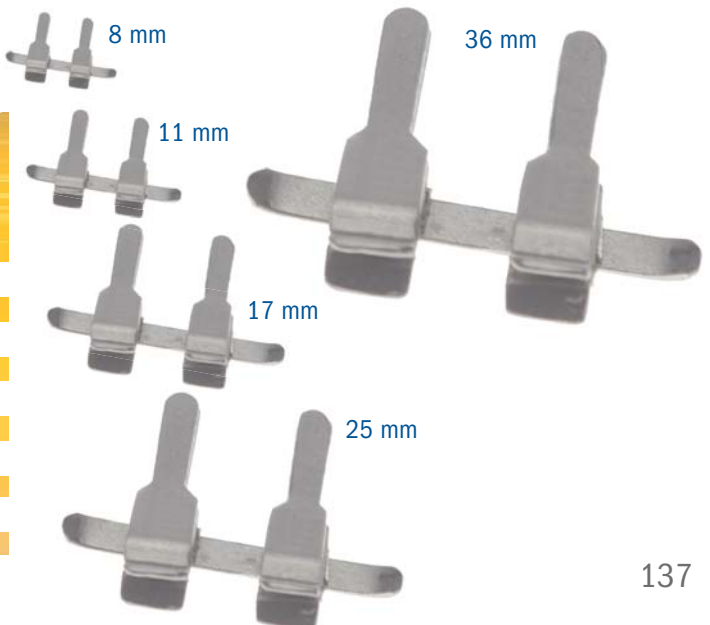

**ACLAND**

38 mm, 1 1/2"	<b>MN 2500</b>	<b>MN 2525</b>	<b>MN 2505</b>	<b>MN 2530</b>	<b>MN 2510</b>	<b>MN 2535</b>
	<i>gerade straight</i>		<i>gebogen curved</i>		<i>Spitze gebogen tips curved</i>	
Schliessdruck Closing force	50 g	80 g	50 g	80 g	50 g	80 g

**MÜLLER**

38 mm, 1 1/2"	<b>MN 2515</b>	<b>MN 2540</b>	<b>MN 2520</b>	<b>MN 2545</b>
	<i>abgewinkelt angled</i>		<i>knie gebogen knee bent</i>	
Schliessdruck Closing force	50 g	80 g	50 g	80 g

**MÜLLER**

<b>Approximatoren Approximators</b>	<b>MN 2391</b>	<b>MN 2392</b>	<b>MN 2393</b>	<b>MN 2394</b>
Ø	1,0 mm	2,0 mm	3,0 mm	4,0 mm
Schliessdruck Closing force	25 -30 g	25 -30 g	25 -30 g	25 -30 g

**MÜLLER**

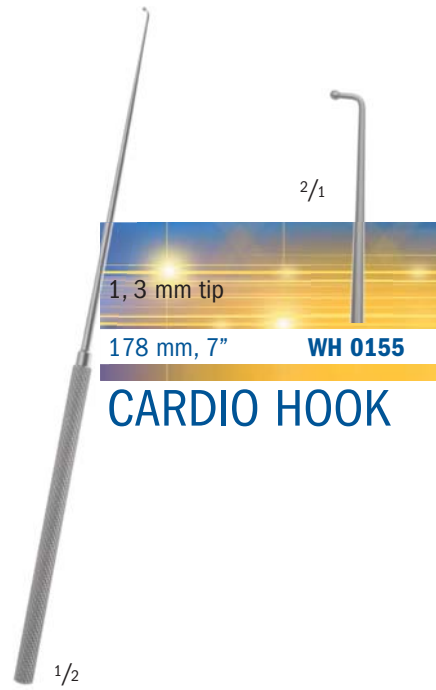

**CARDIO HOOK**  
 für Faden knüpfen  
 for suture

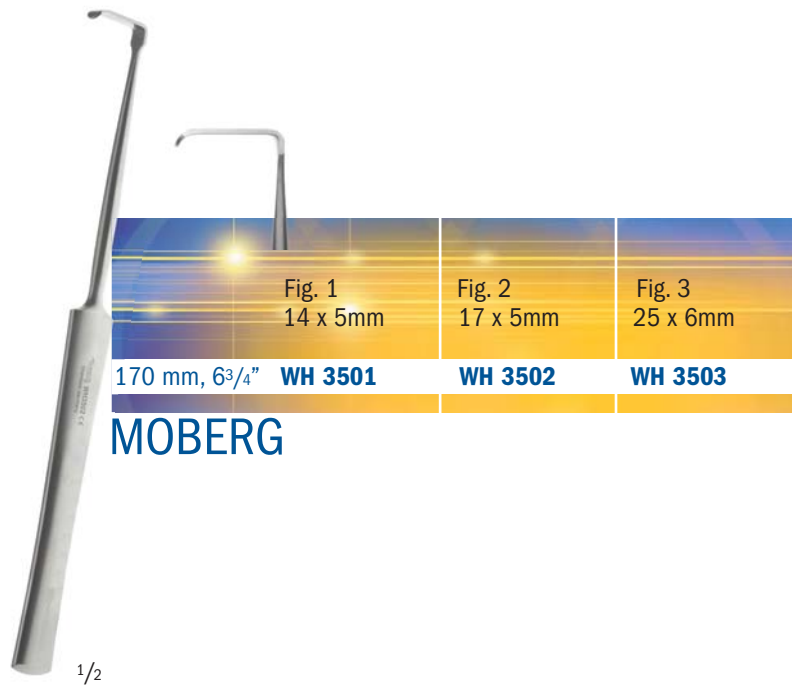



**feine Hauthäkchen**  
*fine skin Hooks*

140 mm, 5 1/2", Fig. 1	8 mm	<b>AU 0360</b>
140 mm, 5 1/2", Fig. 2	10 mm	<b>AU 0361</b>
140 mm, 5 1/2", Fig. 3	12 mm	<b>AU 0370</b>
140 mm, 5 1/2", Fig. 4	14 mm	<b>AU 0380</b>
140 mm, 5 1/2", Fig. 5	16 mm	<b>AU 0390</b>
140 mm, 5 1/2", Fig. 6	18 mm	<b>AU 0400</b>

**DESMARRES**



**feine Hauthäkchen, GRIP HANDLE**  
*fine skin Hooks, GRIP HANDLE*

160 mm, 6 1/4", Fig. 1	8 mm	<b>AU 0359</b>
160 mm, 6 1/4", Fig. 2	10 mm	<b>AU 0362</b>
160 mm, 6 1/4", Fig. 3	12 mm	<b>AU 0371</b>
160 mm, 6 1/4", Fig. 4	14 mm	<b>AU 0381</b>
160 mm, 6 1/4", Fig. 5	16 mm	<b>AU 0391</b>
160 mm, 6 1/4", Fig. 6	18 mm	<b>AU 0401</b>

**DESMARRES**



Fig. 1 13 x 13mm	Fig. 2 13 x 16mm
180 mm, 7" <b>WH 0820</b>	<b>WH 0830</b>

**KÖNIG**



<b>GRIP HANDLE</b> Fig. 1 <b>GRIP HANDLE</b> 15 x 6mm	Fig. 2 20 x 5mm	Fig. 3 25 x 6mm	Fig. 4 30 x 8mm
160 mm, 6 1/4" <b>WH 3651</b>	<b>WH 3661</b>	<b>WH 3671</b>	<b>WH 3681</b>

**MINI-LANGENBECK**



1/2

<b>scharf</b> <b>sharp</b>	Fig. 1 1-zahnig 1-prongs	Fig. 2 2-zahnig 2-prongs	Fig. 3 3-zahnig 3-prongs	Fig. 4 4-zahnig 4-prongs
	160 mm, 6 <sup>1</sup> / <sub>4</sub> "	<b>WH 0470</b>	<b>WH 0480</b>	<b>WH 0490</b>



1/2

<b>stumpf</b> <b>blunt</b>	Fig. 1 1-zahnig 1-prongs	Fig. 2 2-zahnig 2-prongs	Fig. 3 3-zahnig 3-prongs	Fig. 4 4-zahnig 4-prongs
	160 mm, 6 <sup>1</sup> / <sub>4</sub> "	<b>WH 0510</b>	<b>WH 0520</b>	<b>WH 0530</b>



1/2

<b>flexibel</b> <b>flexible</b>	Fig. 1 1-zahnig 1-prongs	Fig. 2 2-zahnig 2-prongs	Fig. 3 3-zahnig 3-prongs	Fig. 4 4-zahnig 4-prongs
	scharf / sharp 160 mm, 6 <sup>1</sup> / <sub>4</sub> "	<b>WH 0629</b>	<b>WH 0630</b>	<b>WH 0640</b>
<b>stumpf / blunt</b>	Fig. 1 1-zahnig 1-prongs	Fig. 2 2-zahnig 2-prongs	Fig. 3 3-zahnig 3-prongs	Fig. 4 4-zahnig 4-prongs
	160 mm, 6 <sup>1</sup> / <sub>4</sub> "	<b>WH 0658</b>	<b>WH 0660</b>	<b>WH 0670</b>

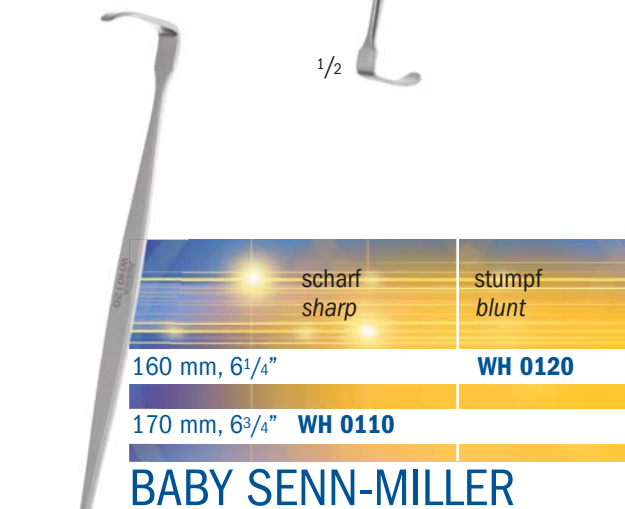



biegsam  
**malleable**



		Länge, length 200mm, 8"	
Breite, width	4 mm		<b>WH 0887</b>
	6 mm		<b>WH 0888</b>
	8 mm	<b>WH 0871</b>	<b>WH 0881</b>
	11 mm	<b>WH 0872</b>	<b>WH 0882</b>
	15 mm	<b>WH 0873</b>	<b>WH 0883</b>
	17 mm	<b>WH 0874</b>	<b>WH 0884</b>
	20 mm	<b>WH 0875</b>	<b>WH 0885</b>
	23 mm	<b>WH 0876</b>	<b>WH 0886</b>

**MARBERGER**

1/2



gefenestert und abgebogen  
*fenestrated and curved*

200 mm, 8" **WH 0138**

**CUSHING**

1/2



		Länge, length 200mm, 8"	
			240mm, 9 1/2"
Fig. 1	8 mm	<b>WH 0847</b>	<b>WH 0852</b>
Fig. 2	10 mm	<b>WH 0848</b>	<b>WH 0853</b>
Fig. 3	12 mm	<b>WH 0849</b>	<b>WH 0854</b>
Fig. 4	14 mm	<b>WH 0850</b>	<b>WH 0855</b>
Fig. 5	16 mm	<b>WH 0851</b>	<b>WH 0856</b>
Fig. 6	18 mm	<b>WH 0858</b>	<b>WH 0857</b>

**CUSHING**

1/2

230 mm, 9" **WH 0139**

**CUSHING**

1/2

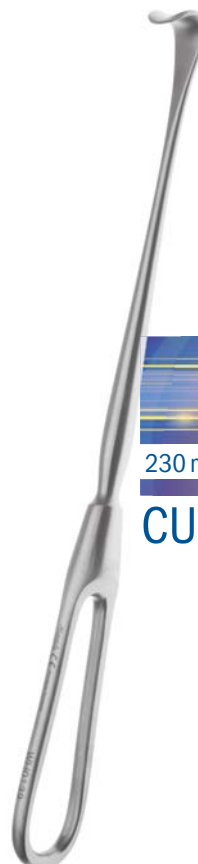

**CUSHING**

	Fig. 1 14 x 11mm	Fig. 2 18 x 13mm	Fig. 3 22 x 15mm
	250 mm, 10" <b>WH 0950</b>	<b>WH 0960</b>	<b>WH 0970</b>

15 x 6 mm stumpf blunt	gezahnt toothed
190 mm, 7 1/2" <b>WH 0800</b>	<b>WH 0810</b>

**STRANDELL-STILLE**

	Fig. 1 9 x 8mm scharf sharp 2-zahnig 2-prongs	Fig. 2 9 x 13mm 3-zahnig 3-prongs	Fig. 3 9 x 19mm 4-zahnig 4-prongs	Fig. 4 9 x 29mm 6-zahnig 6-prongs	Fig. 5 9 x 40mm 8-zahnig 8-prongs
	220 mm, 8 3/4" <b>WH 1130</b>	<b>WH 1140</b>	<b>WH 1150</b>	<b>WH 1160</b>	<b>WH 1170</b>

	Fig. 1 9 x 8mm stumpf blunt 2-zahnig 2-prongs	Fig. 2 9 x 13mm 3-zahnig 3-prongs	Fig. 3 9 x 19mm 4-zahnig 4-prongs	Fig. 4 9 x 29mm 6-zahnig 6-prongs	Fig. 5 9 x 40mm 8-zahnig 8-prongs
	220 mm, 8 3/4" <b>WH 1180</b>	<b>WH 1190</b>	<b>WH 1200</b>	<b>WH 1210</b>	<b>WH 1221</b>

	Fig. 1 9 x 8mm halbscharf semi sharp 2-zahnig 2-prongs	Fig. 2 9 x 13mm 3-zahnig 3-prongs	Fig. 3 9 x 19mm 4-zahnig 4-prongs	Fig. 4 9 x 29mm 6-zahnig 6-prongs	Fig. 5 9 x 40mm 8-zahnig 8-prongs
	220 mm, 8 3/4" <b>WH 1220</b>	<b>WH 1240</b>	<b>WH 1250</b>	<b>WH 1260</b>	<b>WH 1300</b>

**VOLKMANN**



stumpf  
blunt  
250 mm, 10" **WH 1390 - WH 1420**

**ISRAEL**



1/2

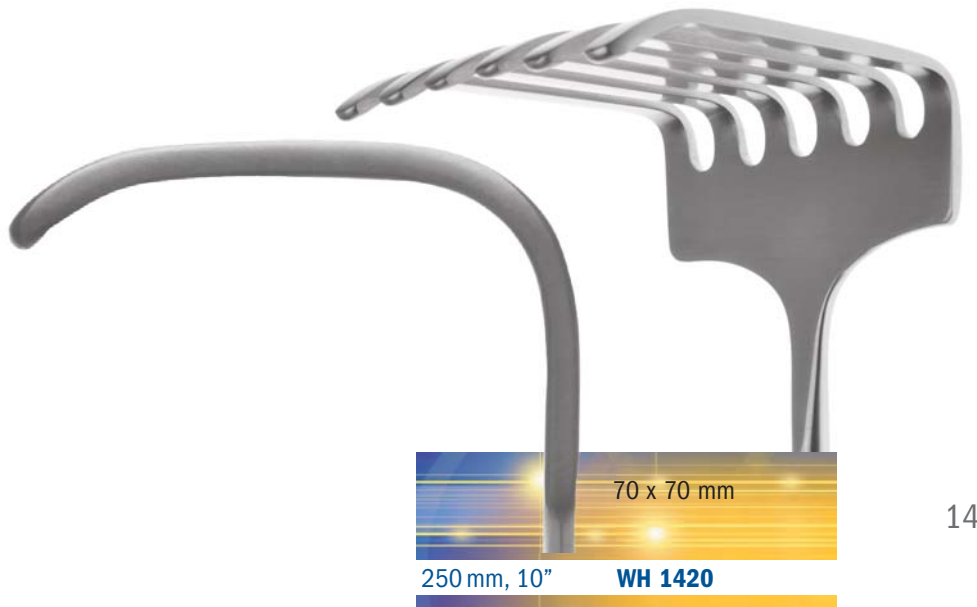



**LANGENBECK**

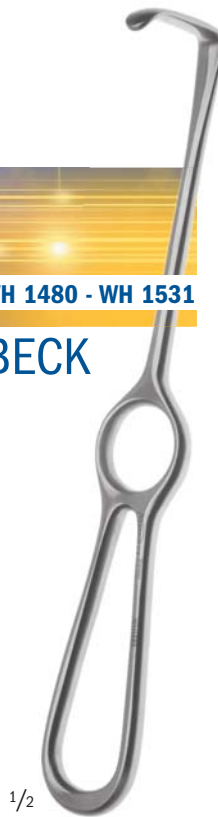

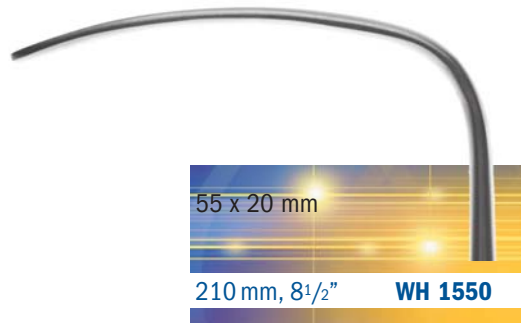
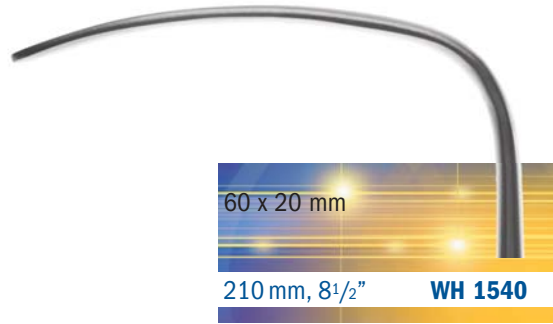

1/2



215 mm, 8<sup>1</sup>/<sub>2</sub>" **WH 1650 - WH 1680**

**KOCHER-  
LANGENBECK**

<sup>1</sup>/<sub>2</sub>



25 x 6 mm

215 mm, 8<sup>1</sup>/<sub>2</sub>" **WH 1650**



25 x 8 mm

215 mm, 8<sup>1</sup>/<sub>2</sub>" **WH 1651**



35 x 8 mm

215 mm, 8<sup>1</sup>/<sub>2</sub>" **WH 1660**



35 x 11 mm

215 mm, 8<sup>1</sup>/<sub>2</sub>" **WH 1670**



35 x 15 mm

215 mm, 8<sup>1</sup>/<sub>2</sub>" **WH 1680**



1/2

## KOCHER- LANGENBECK

45 x 20 mm **WH 1691**

40 x 15 mm **WH 1692**

40 x 25 mm **WH 1693**

45 x 25 mm **WH 1694**

50 x 30 mm **WH 1695**

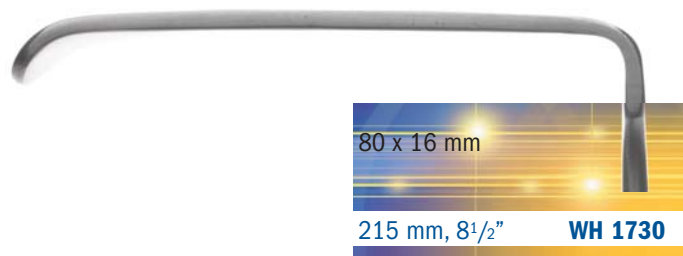
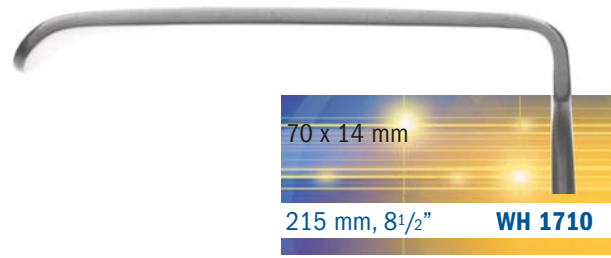
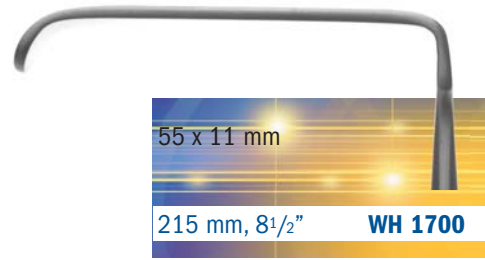



230mm, 9 1/2" WH 1740 - WH 1780

**KOCHER**

1/2



40 x 18 mm **WH 1740**



60 x 20 mm **WH 1750**



60 x 25 mm **WH 1760**



75 x 30 mm **WH 1770**



75 x 40 mm **WH 1780**



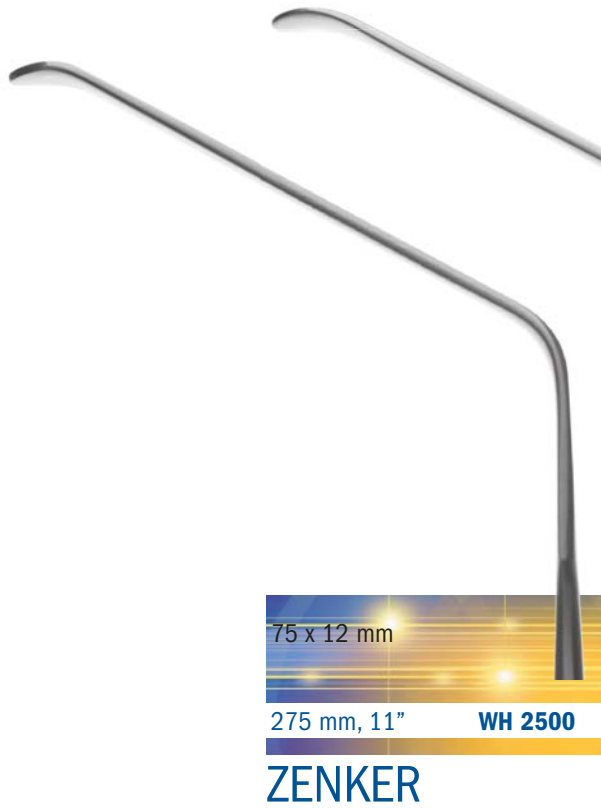

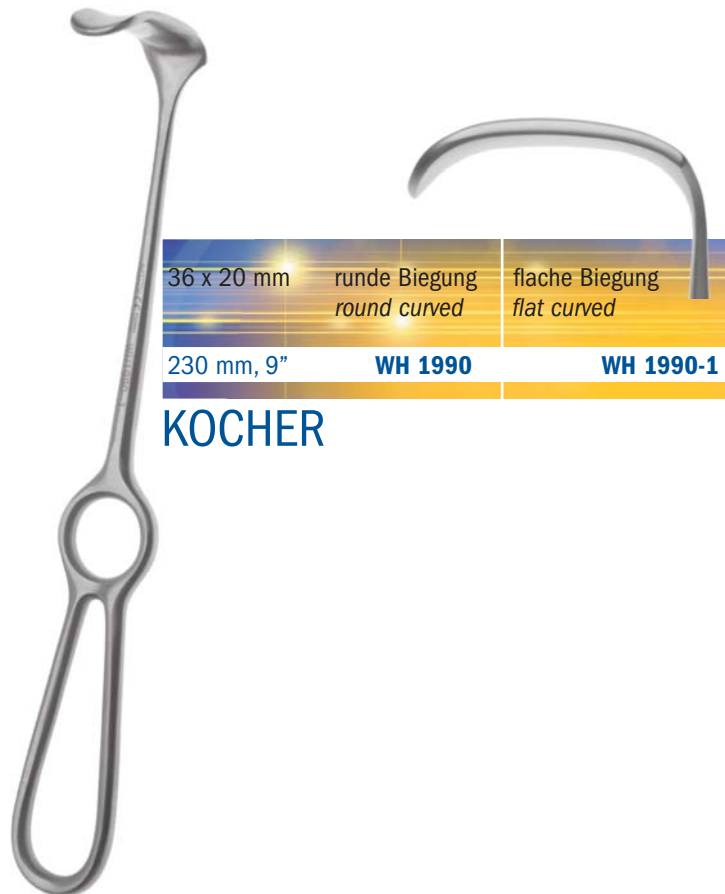
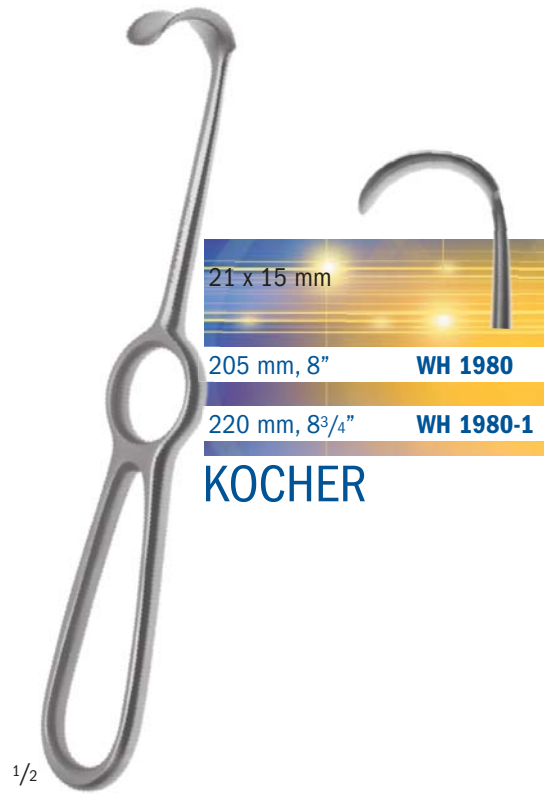

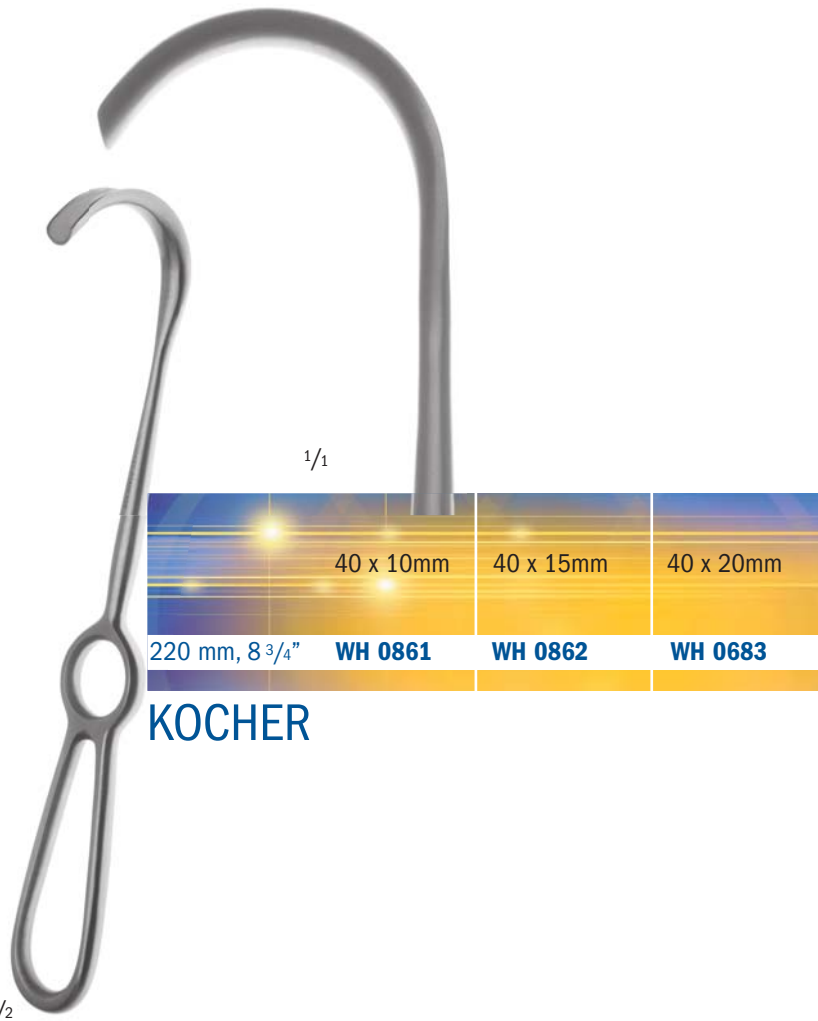
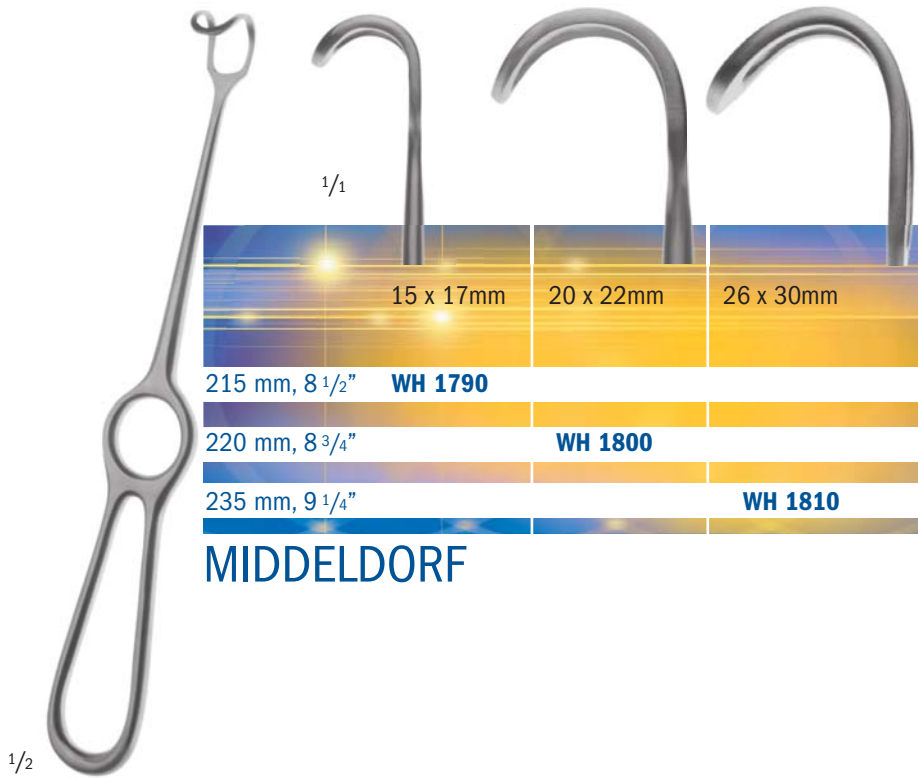

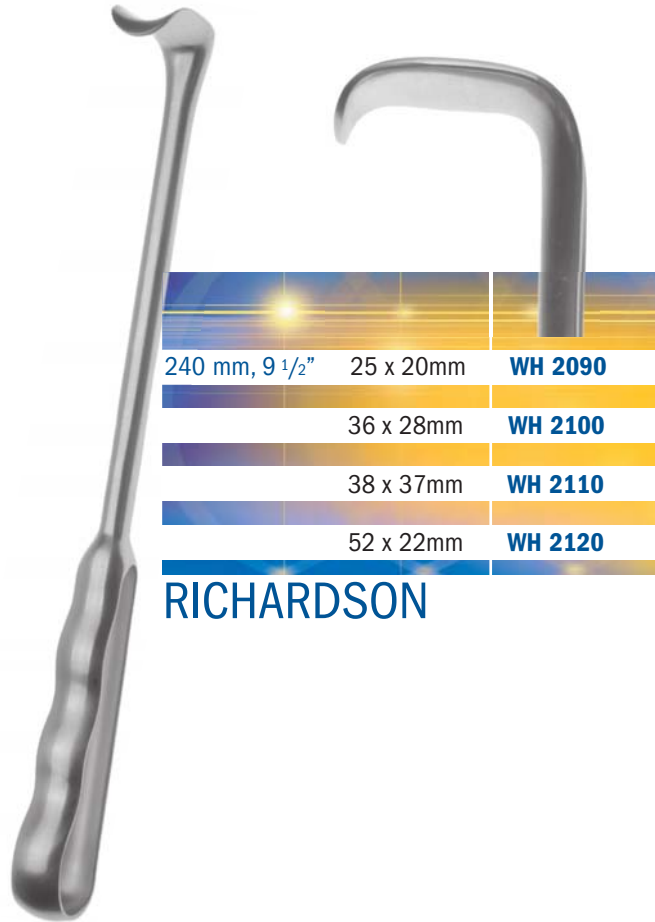

**RICHARDSON**



**KOCHER**



**KOCHER**



1/1

WH 2400  
Fig. 1  
127 x 40 mm



1/1

WH 2410  
Fig. 2  
127 x 62 mm



flexibel  
flexible

320 mm, 12 1/2" 127 x 40 mm **WH 2400**

127 x 62 mm **WH 2410**

**HARRINGTON**

1/2

Fig. 1  
25 mm

300 mm, 12" **WH 2540**

**DEAVER**

1/2

Fig. 2  
25 mm

315 mm, 12<sup>3</sup>/<sub>8</sub>" **WH 2550**

**DEAVER**

1/2

Fig. 2<sup>1</sup>/<sub>2</sub>  
25 mm

365 mm, 14" **WH 2590**

**DEAVER**

1/2

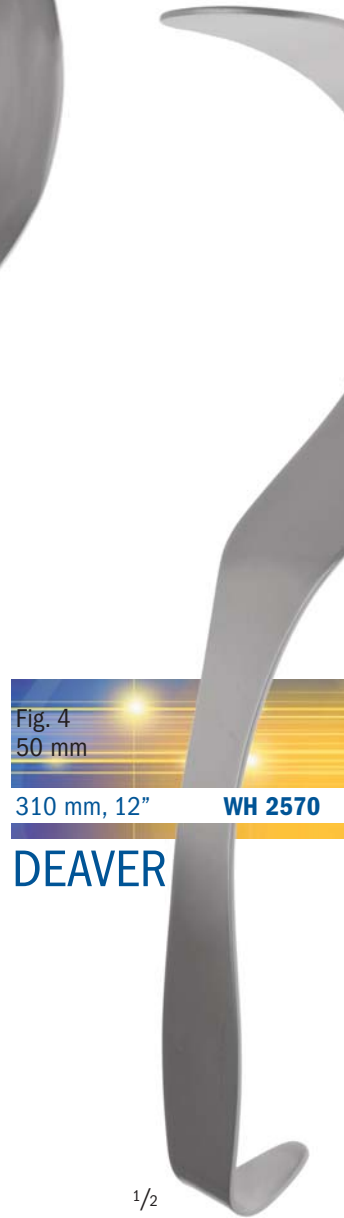

Breite  
width 40 mm  
255 mm, 10" **WH 2440**

**ALLISON**



Breite  
width 54 mm  
310 mm, 12" **WH 2450**

**ALLISON**



Breite  
width 130 mm  
300 mm, 12" **WH 2460**

**ORGANSPATEL  
CHEST SPATULA**

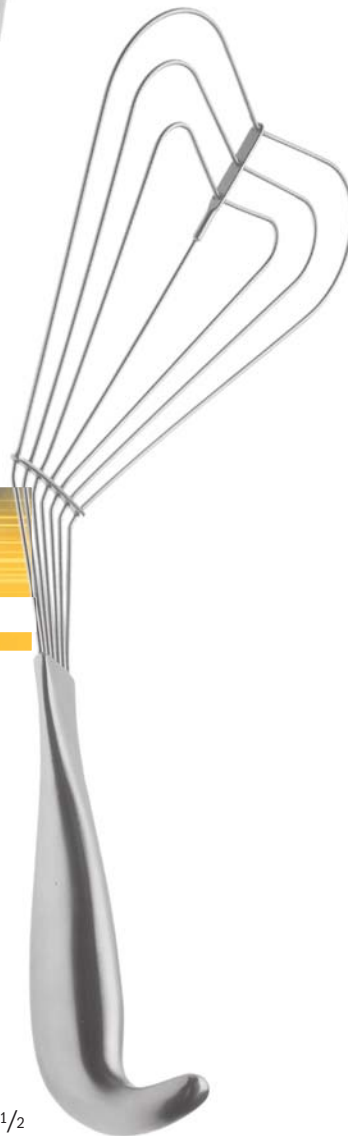

Breite  
width 89 x 83 mm  
195 mm, 7<sup>3</sup>/<sub>4</sub>" **WH 2390**

**DAVIDSON  
SCAPULA-HAKEN  
SCAPULA RETRACTOR**





Wundhakenbezüge  
 Wound retractor cover

HBS 0040 - HBS 0400

**SOFT COVER**

steril verpackt  
 steril packed as disposable

Details siehe Seite BL 160  
 details see page BL 160

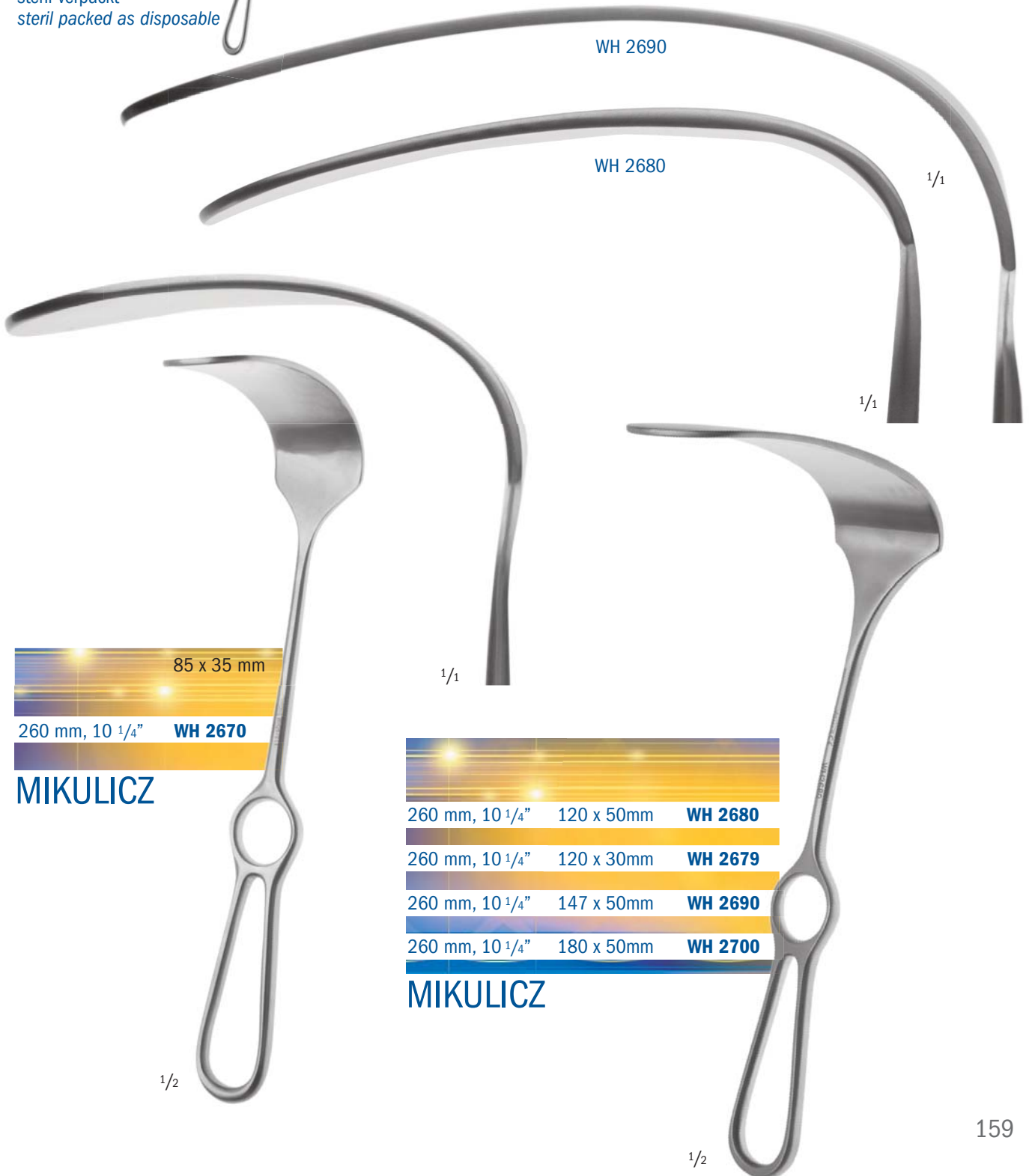

WH 2690

WH 2680

1/1

1/1

1/1

85 x 35 mm

260 mm, 10 1/4" **WH 2670**

**MIKULICZ**

260 mm, 10 1/4"	120 x 50mm	<b>WH 2680</b>
260 mm, 10 1/4"	120 x 30mm	<b>WH 2679</b>
260 mm, 10 1/4"	147 x 50mm	<b>WH 2690</b>
260 mm, 10 1/4"	180 x 50mm	<b>WH 2700</b>

**MIKULICZ**

1/2

1/2

WH 2720  
150 x 57 mm

WH 2710  
150 x 38 mm

WH 2721  
190 x 57 mm

WH 2722  
190 x 38 mm

1/2

1/1

WH 2711  
130 x 38 mm

1/1

**Wundhakenbezüge**  
**Wound retractor cover**

180 x 25 mm **HBS 0100**

200 x 19 mm **HBS 0040**

250 x 14 mm **HBS 0060**

255 x 25 mm **HBS 0065**

205 x 45 mm **HBS 0150**

235 x 50 mm **HBS 0200**

310 x 35 mm **HBS 0210**

305 x 40 mm **HBS 0300**

305 x 50 mm **HBS 0350**

330 x 50 mm **HBS 0400**

**SOFT COVER**

Gebrauchsmusterschutz  
steril verpackt  
*legal protection of registered designs*  
*steril packed as disposable*

270 mm, 10 1/2"	150 x 57mm	<b>WH 2720</b>
270 mm, 10 1/2"	150 x 38mm	<b>WH 2710</b>
270 mm, 10 1/2"	130 x 38mm	<b>WH 2711</b>
270 mm, 10 1/2"	190 x 57mm	<b>WH 2721</b>
270 mm, 10 1/2"	190 x 38mm	<b>WH 2722</b>

**KELLY**

1/2

18 x 21 mm

**doppelt**  
**double**

130 mm, 5 1/8" **WH 0170**

## BABY-ROUX

15 x 15 mm  
1/2



**einzel**  
**alone**

24 x 20 mm, 30 x 28 mm **WH 0250**

27 x 26 mm, 37 x 32 mm **WH 0260**

35 x 29 mm, 38 x 43 mm **WH 0270**

**Satz**  
**Set**

165 mm, 6 1/2" **WH 0240**

## ROUX

**einzel**  
**alone**

21 x 24 mm, 40 x 15 mm **WH 0321**

25 x 24 mm, 45 x 15 mm **WH 0322**

**Satz**  
**Set**

210 mm, 8 1/4" **WH 0320**

## PARKER-LANGENBECK "US ARMY"

1/2



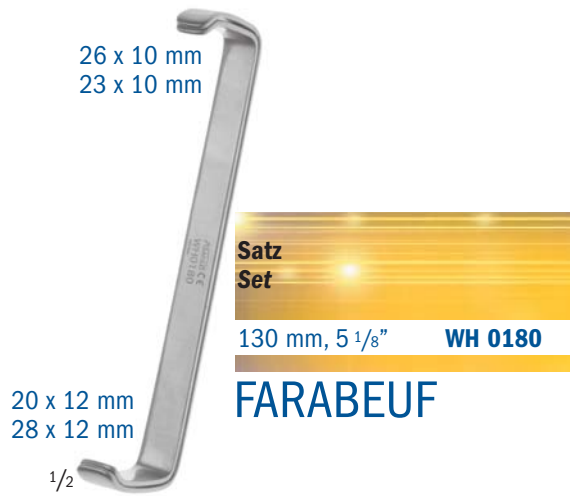

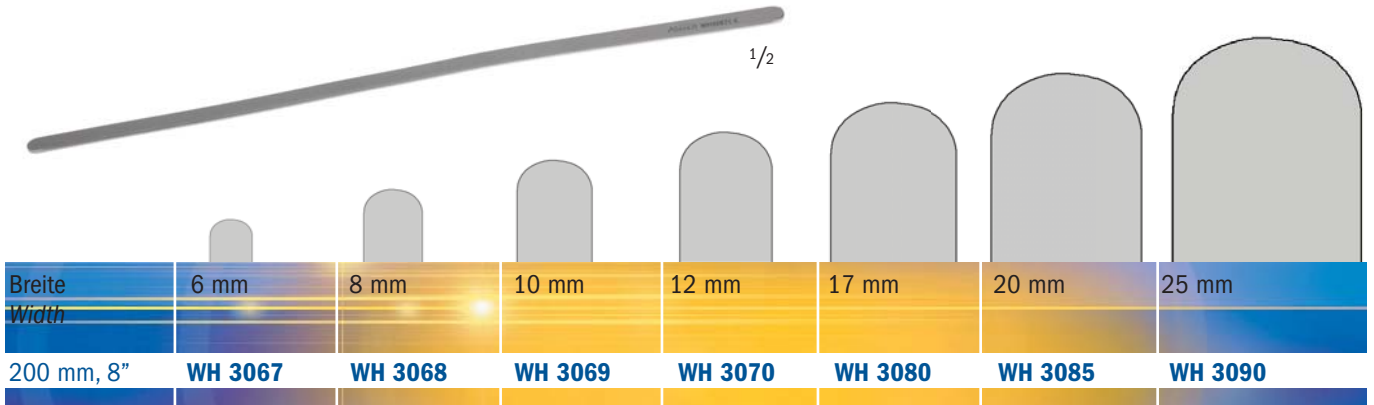

**MATHIEU**  
BIEGSAM / MALLEABLE

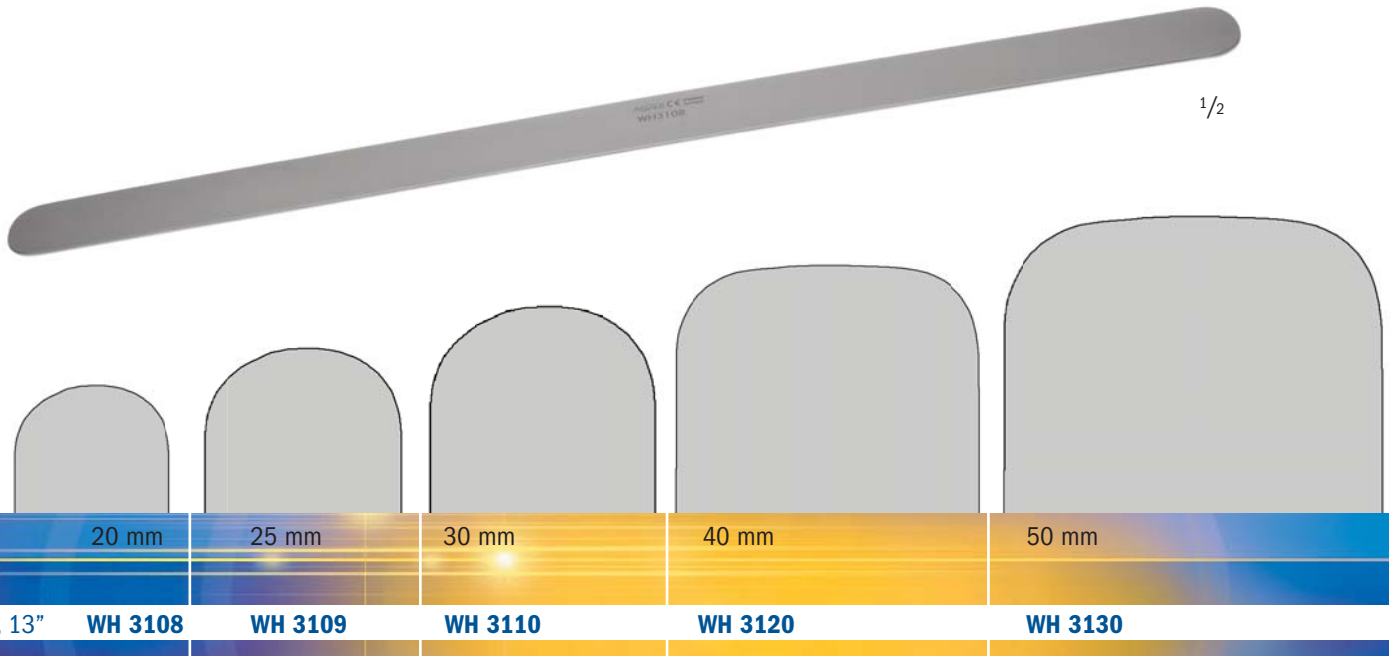

BIEGSAM / MALLEABLE

1/2

4 x 4 Zähne 4 x 4 teeth	scharf sharp	stumpf blunt
70 mm, 2 3/4"	<b>WH 5071</b>	<b>WH 5070</b>
100 mm, 4"	<b>WH 5081</b>	<b>WH 5080</b>

3 x 4 Zähne 3 x 4 teeth	scharf sharp	stumpf blunt
70 mm, 2 3/4"	<b>WH 5010</b>	<b>WH 5020</b>

**FINSEN**

1/2

1/2

**ALM**



1/2

2 x 3 Zähne Spreizweite 35 mm 2 x 3 teeth wide 35 mm	scharf sharp	stumpf blunt	halbscharf semi sharp
110 mm, 4 1/2"	<b>WH 5180</b>	<b>WH 5210</b>	<b>WH 5150</b>

**WEITLANER**

3 x 4 Zähne 3 x 4 teeth	scharf sharp	halbscharf semi sharp	stumpf blunt
135 mm, 5 1/2"	<b>WH 5190</b>	<b>WH 5160</b>	<b>WH 5220</b>
165 mm, 6 1/2"	<b>WH 5200</b>	<b>WH 5170</b>	<b>WH 5230</b>
200 mm, 8"	<b>WH 5380</b>		<b>WH 5390</b>

**WEITLANER**

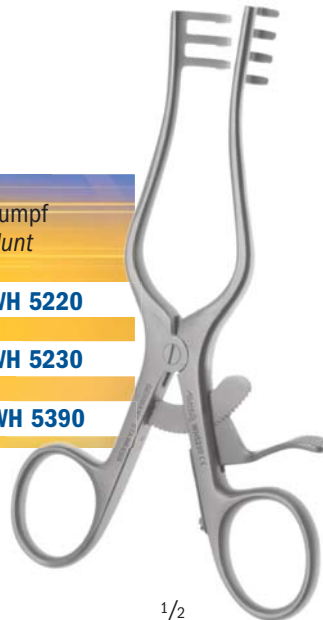

1/2



1/2

4 x 4 Zähne	gerade scharf straight	gerade scharf straight	abgewinkelt halbscharf angled
4 x 4 teeth	sharp	sharp	semi sharp
190 mm, 7 1/2"	<b>WH 5255</b>		<b>WH 5359</b>
265 mm, 10 1/2"	<b>WH 5372</b>		

### ADSON

mit Gelenk <i>rotatable possibility</i>	scharf sharp	stumpf blunt
140 mm, 5 1/2"	<b>WH 5281</b>	<b>WH 5280</b>
160 mm, 6 1/4"	<b>WH 5285</b>	<b>WH 5286</b>
200 mm, 8"	<b>WH 5287</b>	<b>WH 5288</b>

### ADSON (BABY) CONE



1/2

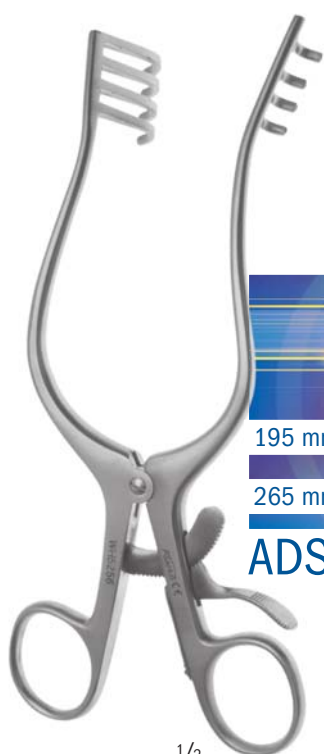

1/2

	scharf 4 x 4 Zähne sharp	stumpf blunt	scharf 6 x 6 Zähne sharp	stumpf blunt
	4 x 4 teeth		6 x 6 teeth	
195 mm, 8"	<b>WH 5255</b>	<b>WH 5256</b>		
265 mm, 10 1/2"			<b>WH 5385</b>	<b>WH 5386</b>

### ADSON

	stumpf links 5 Zähne rechts 4 Zähne <i>blunt</i> left 5 teeth right 4 teeth	stumpf links 4 Zähne rechts 5 Zähne <i>blunt</i> left 4 teeth right 5 teeth	halbscharf links 5 Zähne rechts 4 Zähne <i>semi sharp</i> left 5 teeth right 4 teeth
320 mm, 12 <sup>3</sup> / <sub>4</sub> "	<b>WH 5371L</b>	<b>WH 5371R</b>	<b>WH 5371-1</b>

**BECKMANN-ADSON**



4 x 4 Zähne, scharf 4 x 4 teeth, sharp
310 mm, 12" <b>WH 5367</b>

**BECKMANN**

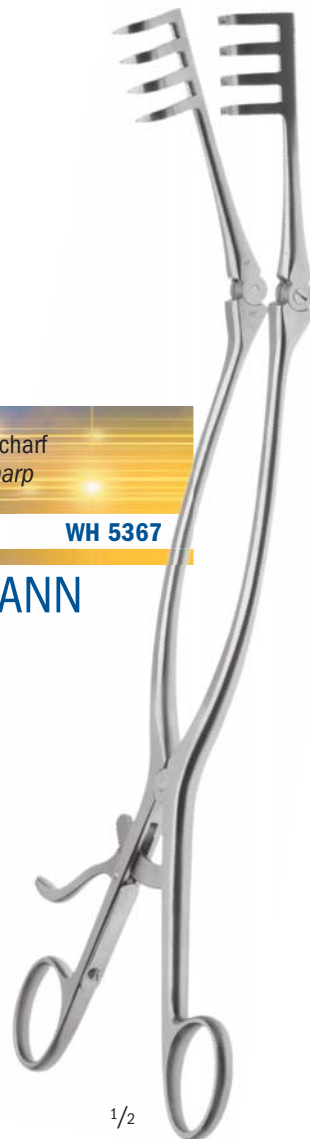





145 mm, 6" **WH 7000**  
**DE BAKEY FEMUR**

1/2



Öffnungsweite opening width		
90 mm, 3 1/2"	50 mm	<b>WH 6965</b>
140 mm, 5 1/2"	70 mm	<b>WH 6970</b>
160 mm, 6 1/4"	80 mm	<b>WH 6975</b>
180 mm, 7"	100 mm	<b>WH 6980</b>

1/2

**GELPI**  
VULVA-SPREIZER / VULVA RETRACTOR



mit Kugelstopper  
with ball stop      Öffnungsweite  
opening width  
180 mm, 7"      100 mm      **WH 6985**  
**GELPI**

1/2

30 mm tief 30 mm deep	Öffnungsweite opening width	
180 mm, 7"	100 mm	<b>WH 6981</b>

**GELPI**

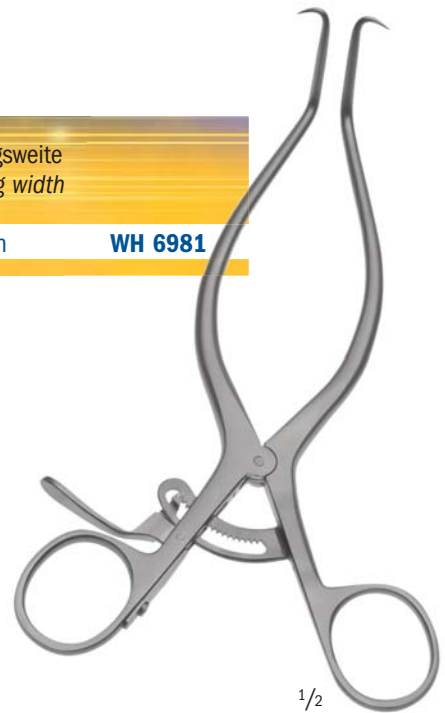

1/2

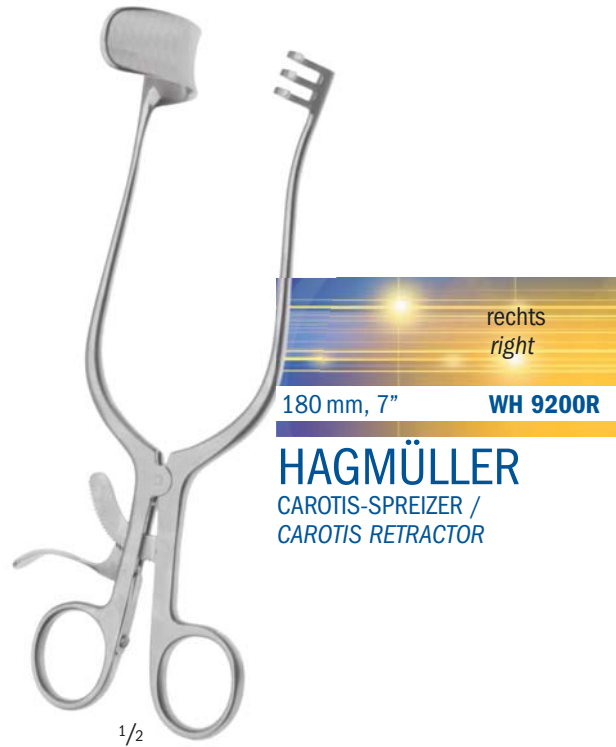
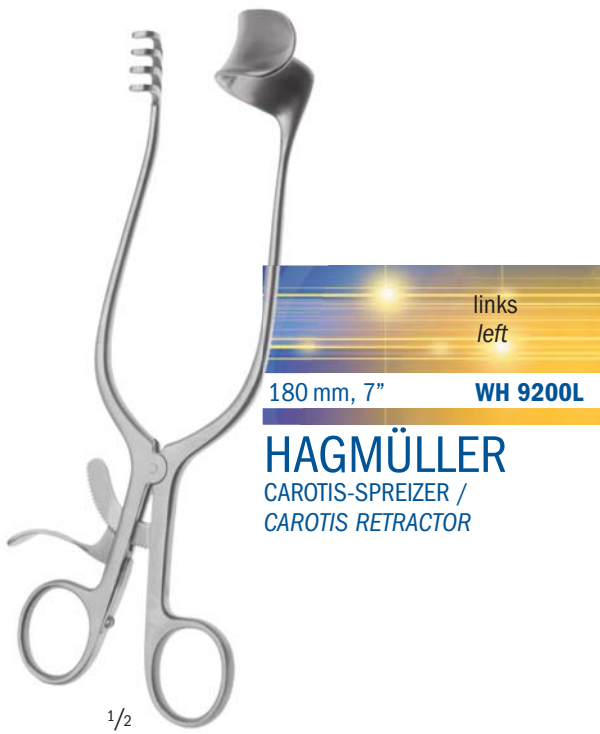

Dieser Spreizer ermöglicht assistenzfreies Retraktieren des Gewebes bei Carotis-Eingriffen und erspart einen zweiten Wundhaken als Gegensperrer.

*This retractor enables retraction for carotid operation with additional retractor hold by an assistant and it saves the second single retractor.*

Einzelhaken mit Assistent entfällt.

*Single retractor not necessary anymore with assistant.*

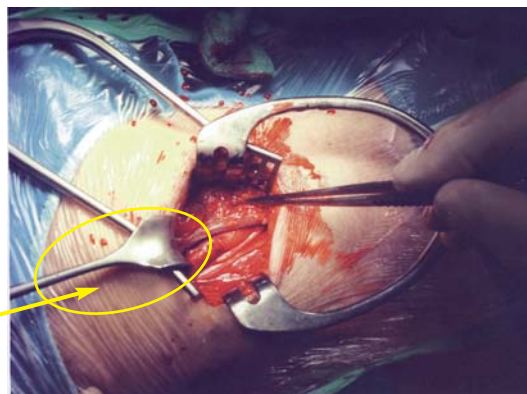

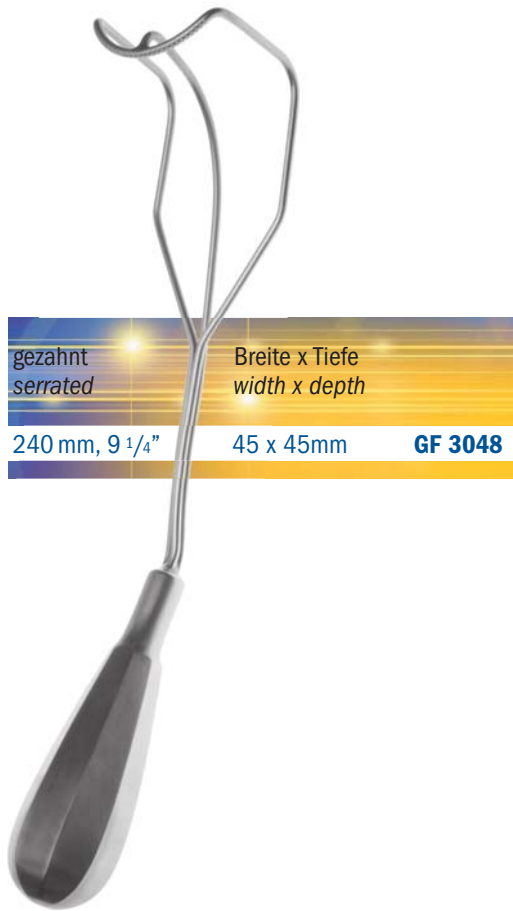

gezahnt serrated	Breite x Tiefe width x depth	
240 mm, 9 1/4"	45 x 45mm	<b>GF 3048</b>

1/2



gezahnt serrated	Breite x Tiefe width x depth	
240 mm, 9 1/4"	small 25 x 20mm	<b>GF 3493</b>
240 mm, 9 1/4"	medium 40 x 30mm	<b>GF 3494</b>
220 mm, 8 3/4"	large 50 x 35mm	<b>GF 3495</b>

**COOLEY**

1/2



	Breite x Tiefe width x depth	gezahntes Ende serrated tip	
220 mm, 8 3/4"	43 x 47mm		<b>GF 3480</b>
220 mm, 8 3/4"	31 x 47mm	rechts/right	<b>GF 3500</b>
220 mm, 8 3/4"	25 x 46mm	links/left	<b>GF 3490</b>

1/2

Mitral-Klappen-Sperrer  
Mitral Valve Retractor

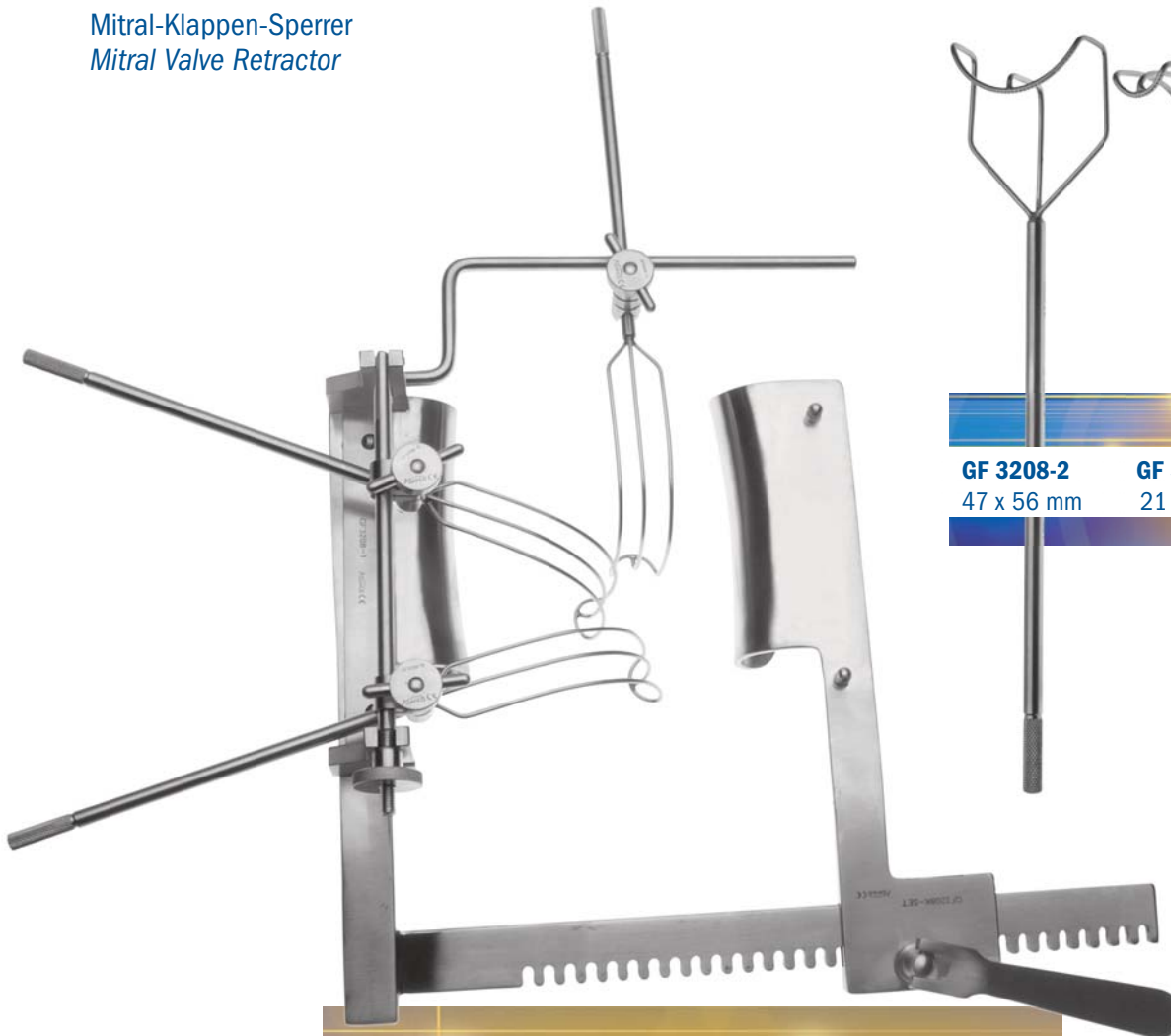

GF 3208-2	GF 3208-3	GF 3208-4
47 x 56 mm	21 x 70 mm	21 x 85 mm

**GF 3208K**

komplett groß, complete large - bestehend aus: / consisting of:

**GF 3208-1** Hauptausleger / main bracket

**GF 3208-2** Tricuspid Sperrerblatt / Tricuspid retractor blade, 240 mm

**GF 3208-3** grosses Sperrerblatt / large retractor blade, 230 mm

**GF 3208-4** kleines Sperrerblatt / small retractor blade, 245 mm

**GF 3208-5** Universal Fixierung / universal fixation clamp

**GF 3208-6** solides Sperrerblatt / solid retractor blade, 100x40 mm

**GF 3208-7** Seitenarmrahmen / side arm bar

**GF 3208-8** Sperrerteil mit Schnellspannaufnahmen allein /  
retractor alone

**GF 3208-9** Fadenfixiereinheit / suture organizer for the bar of spreader

**GF 3208-10** kleines Sperrerblatt 22 mm breit, 220 mm lang/  
small retractor blade, 22 mm wide, 220 mm long



**GF 3334**

## POPLITEA

Infragenualer Retraktor zur dist. Arteria Poplitea und zum Trucus Tibioperoneus, ohne Fiberlichtträger.  
*Infragenualer Retractor for dist. Artery Poplitea and Trucus Tibioperoneus, without fibre optical.*

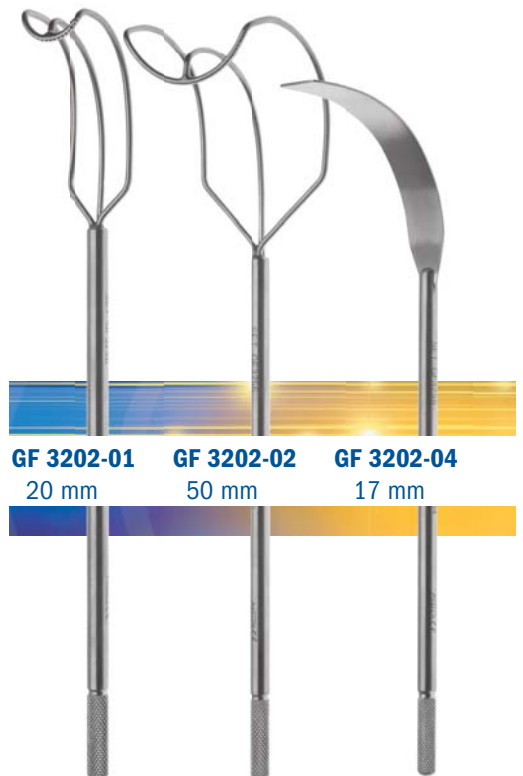

**GF 3256 Set**

komplett mit T-Rahmen, 2 Fixierklammern und 3 artrial Haken  
*complete of T-Bar, 2 fixation clamps and 3 artrial hooks*

**GF 3381**

Sperrer allein, für Erwachsene  
*Spreader only, for adults*

**GF 3202-01**

Mitral Valve schmal, Fig. 1, 20 mm breit und rund  
*Mitral Valve narrow, Fig. 1, 20 mm wide and round shape*

**GF 3202-02**

Mitral Valve, Fig. 3, 50 mm breit und rund  
*Mitral Valve, Fig. 3, 50 mm wide and round shape*

**GF 3202-04**

biegsamer Spatel, 17 mm breit  
*malleable artrial spatula, 17 mm wide*

Sternum-Sperrer für Mamaria Arterie  
Sternum-Retractor for Mamaria Arteria

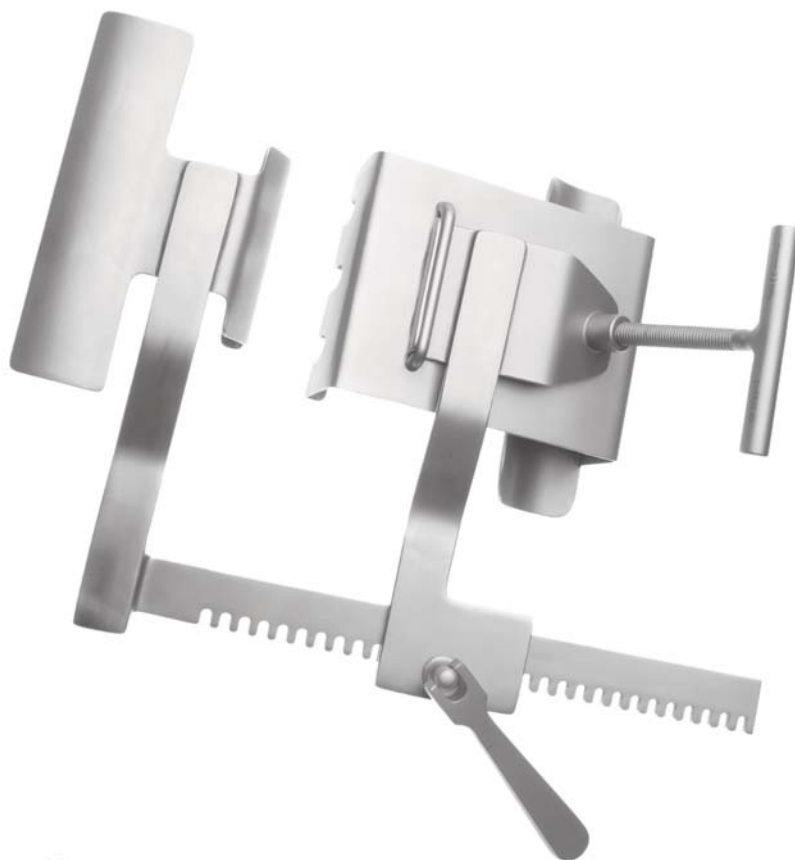

**GF 3245 Links / left**  
**GF 3246 Rechts / right**

**GF 3245-1**  
T-Griff mit Gewinde  
*T-handle with thread*

**GF 3245-2**  
Blatt alleine, beweglich  
*blade only, flexible*

## I.M.A. RETRACTOR

komplett / *complete*  
*not for USA market available*

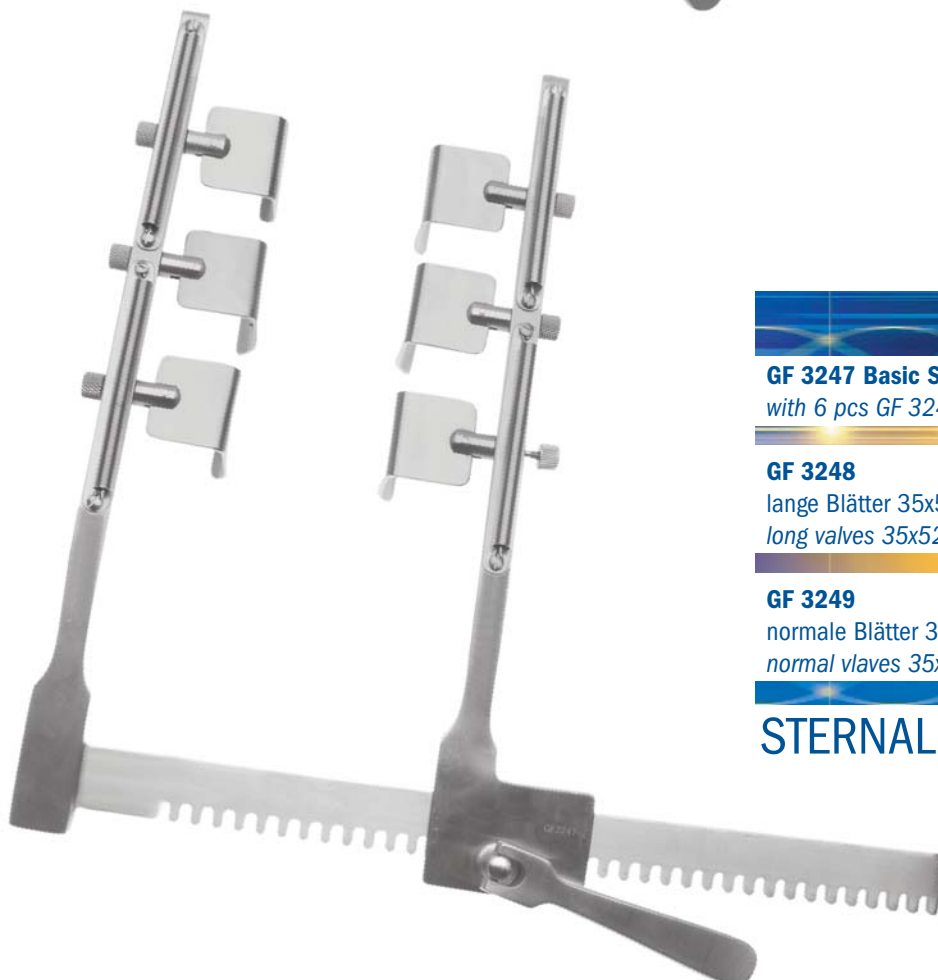

**GF 3247 Basic Set**  
*with 6 pcs GF 3249*

**GF 3248**  
lange Blätter 35x52 mm, 6 St.  
*long valves 35x52 mm, 6 pcs*

**GF 3249**  
normale Blätter 35x35 mm, 6 St.  
*normal valves 35x35 mm, 6 pcs*

## STERNAL RETRACTOR

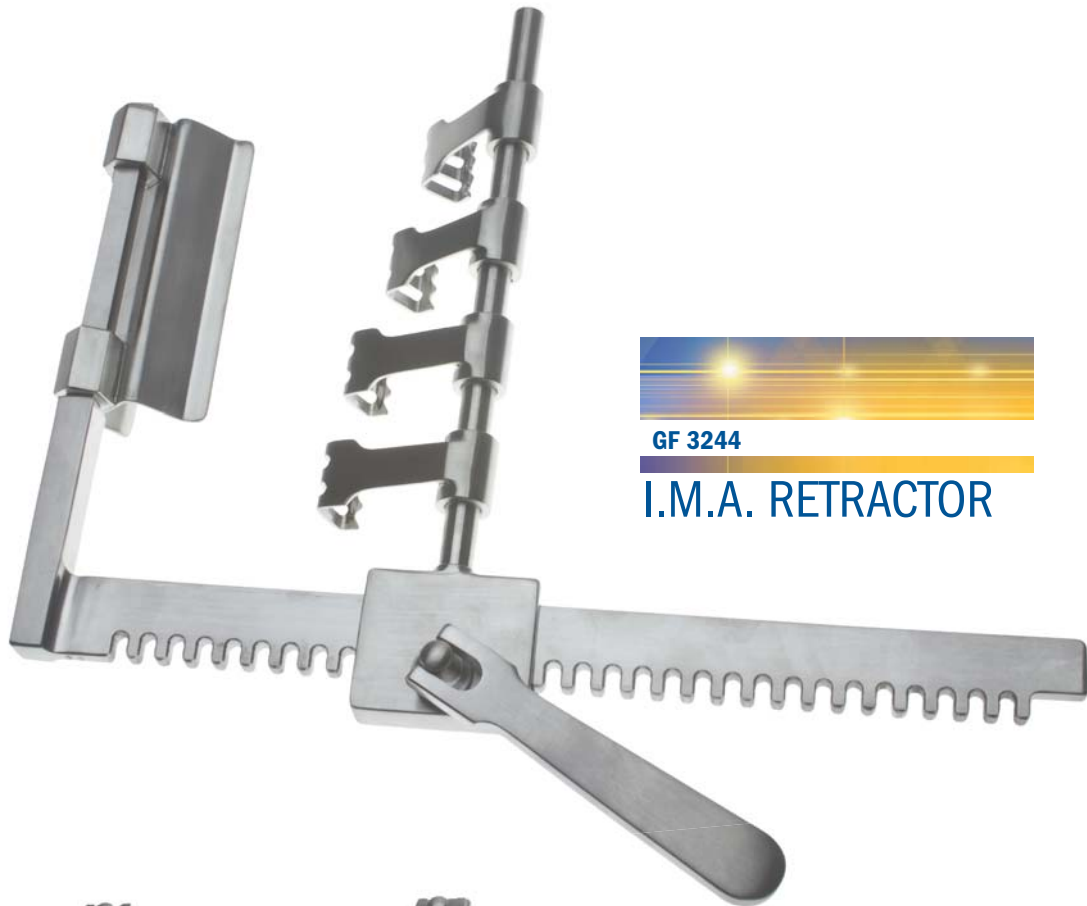

GF 3244

I.M.A. RETRACTOR



220 mm Spreizweite / spread  
2 Paar Valven / 2 pair valves  
Stahl / steel

GF 3100

FINOCHIETTO-BURFORD



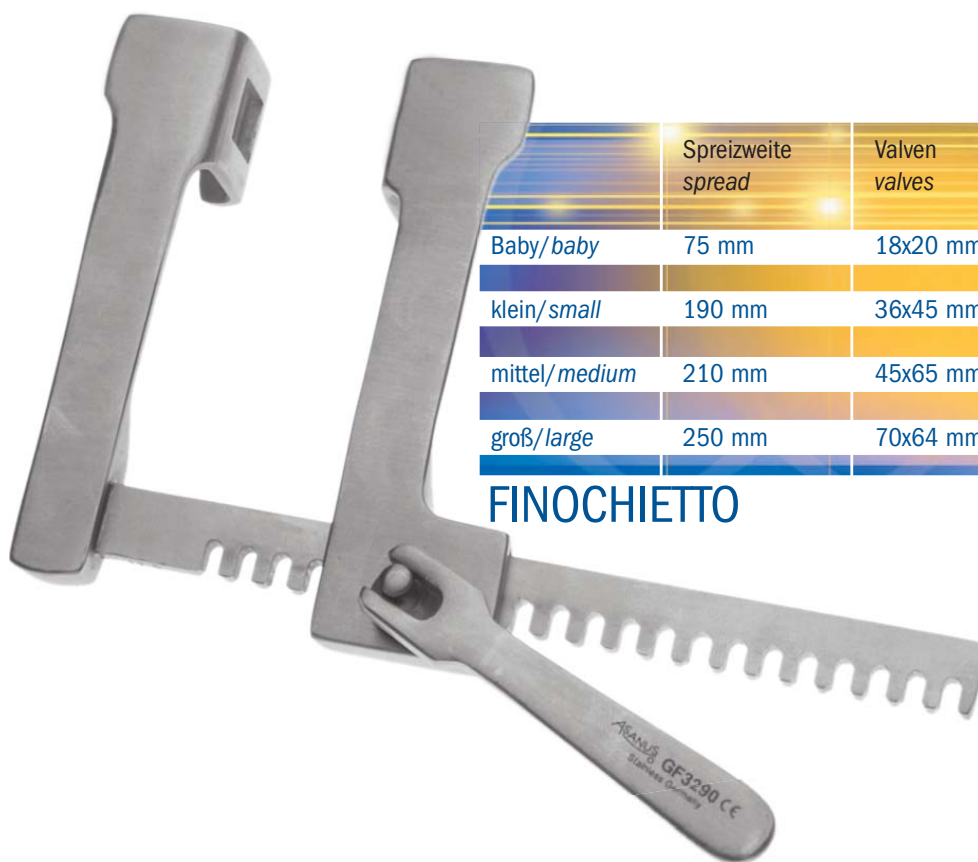

	Spreizweite spread	Valven valves	Stahl steel	Aluminium aluminium
Baby/baby	75 mm	18x20 mm	<b>GF 3290</b>	<b>GF 3290A</b>
klein/small	190 mm	36x45 mm	<b>GF 3070</b>	<b>GF 3070A</b>
mittel/medium	210 mm	45x65 mm	<b>GF 3080</b>	<b>GF 3080A</b>
groß/large	250 mm	70x64 mm	<b>GF 3090</b>	<b>GF 3090A</b>

## FINOCHIETTO



Aluminium Light weight  
 2 auswechselbare Valven  
 Aluminium Light weight  
 2 exchangeable valves

**GF 3101**

**BURFORD**  
 KINDERSPERRER  
 CHILDREN RETRACTOR



Valven allein /  
 Valves only

**GF 3102** 34 x 42 mm

**GF 3103** 48 x 42 mm



35 mm Spreizweite / *spread*  
10x7 mm Valve

**WH 0001**

## MICRO FINOCHIETTO



60 mm Spreizweite / *spread*  
Wechselvalven 15x20 und 15x10mm  
*Valves 15x20 and 15x10mm*

**WH 8000**

## TITAN FINOCHIETTO

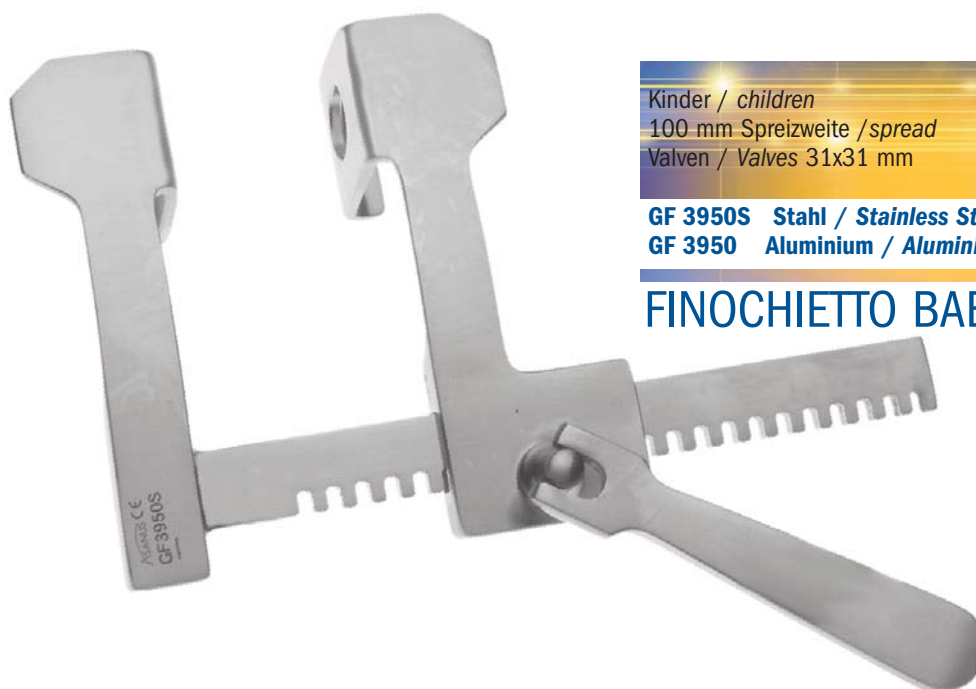

Kinder / children  
100 mm Spreizweite / spread  
Valven / Valves 31x31 mm

GF 3950S Stahl / Stainless Steel  
GF 3950 Aluminium / Aluminium

## FINOCHIETTO BABY HAIGHT



Kleinstkinder / baby  
75 mm Spreizweite / spread  
Valven / Valves 15x15 mm

GF 3940S Stahl / Stainless Steel  
GF 3940 Aluminium / Aluminium

## FINOCHIETTO INFANT



Kleinstkinder / baby MINI  
36 mm Spreizweite / spread  
Valven / Valves 7x7 mm

GF 3407

## FINOCHIETTO INFANT

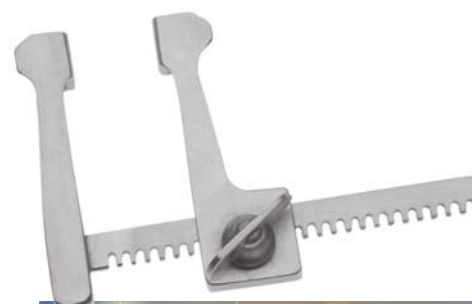

Kleinstkinder / baby MINI  
36 mm Spreizweite / spread  
Valven / Valves 7x7 mm

GF 3470-1 mit Flügelhebel / with wing screw

## FINOCHIETTO INFANT

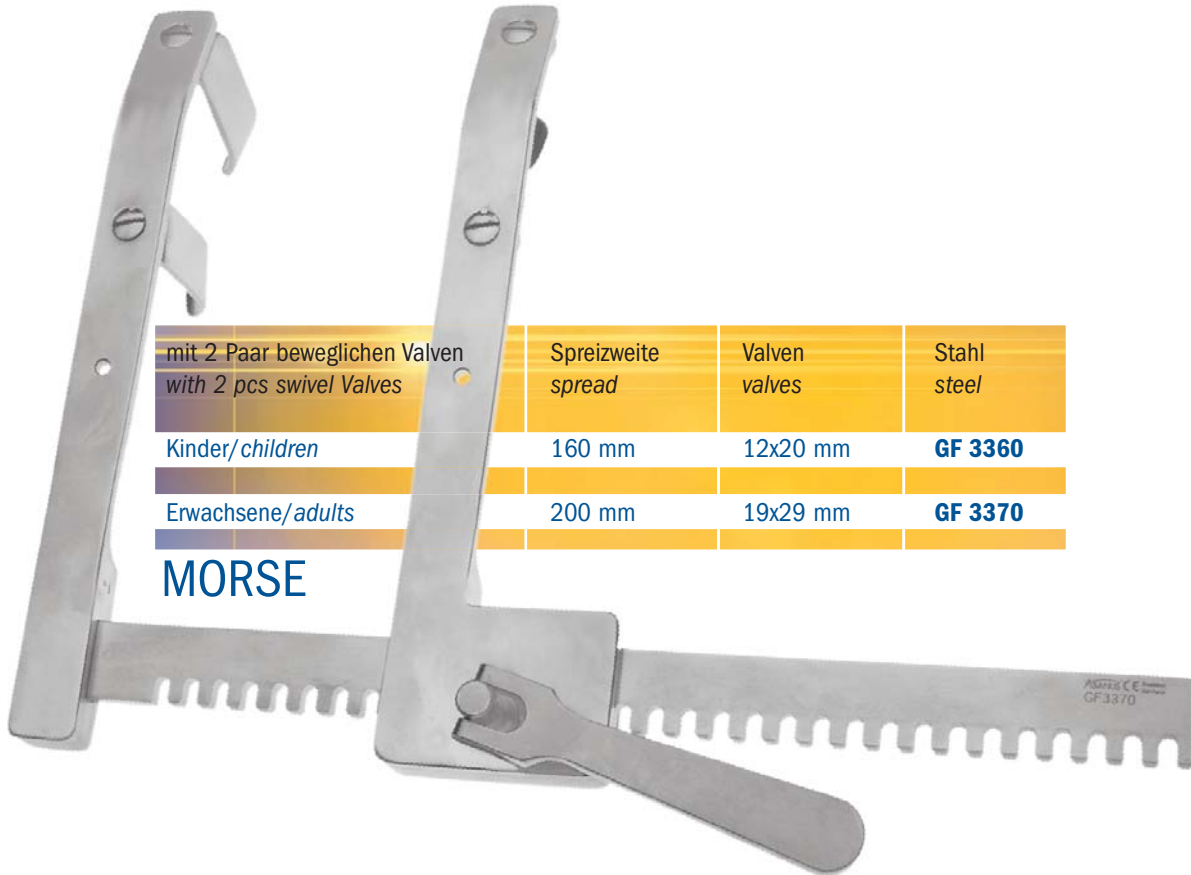

mit 2 Paar beweglichen Valven with 2 pcs swivel Valves	Spreizweite spread	Valven valves	Stahl steel
Kinder/children	160 mm	12x20 mm	<b>GF 3360</b>
Erwachsene/adults	200 mm	19x29 mm	<b>GF 3370</b>

**MORSE**

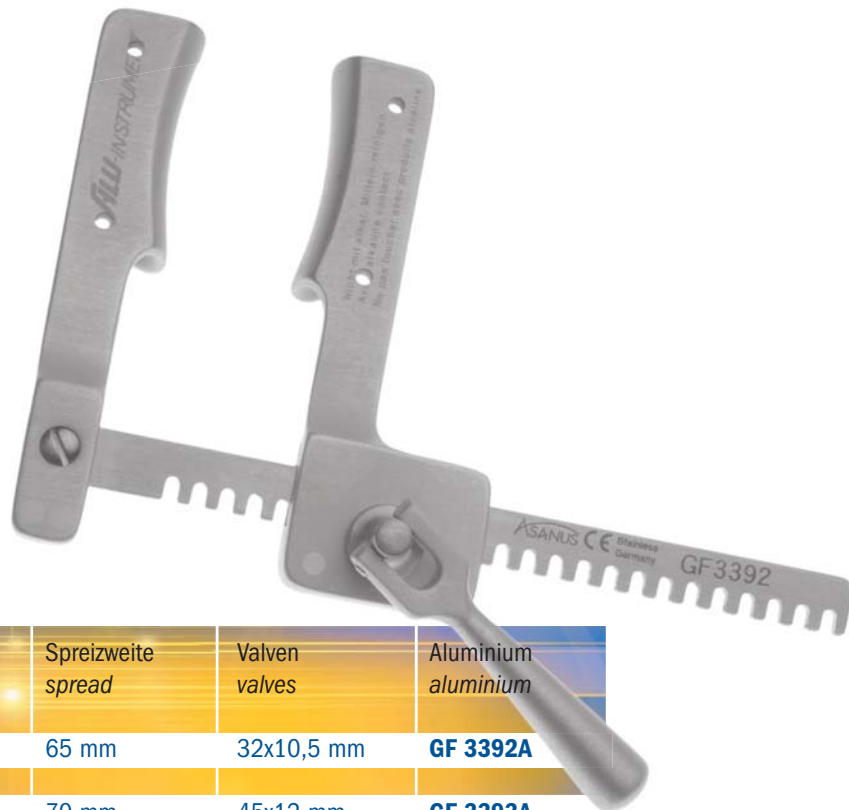

	Spreizweite spread	Valven valves	Aluminium aluminium
Neugeboren/newborn	65 mm	32x10,5 mm	<b>GF 3392A</b>
Kleinstkinder/babies	70 mm	45x12 mm	<b>GF 3393A</b>
Kinder/children	120 mm	60x15 mm	<b>GF 3394A</b>

**CASTANEDA**

mit concave-convex Valven/with concave-convex blades



1 Paar Blätter allein /  
1 pair of blades only

**GF 3210** 60x60 mm

**GF 3220** 50x80 mm

**GF 3230** 40x100 mm

**GF 3240** 80x60 mm

Sternum- und Rippensperrer  
mit 3 Paar Blättern /  
Sternal retractor complete  
with 3 pairs of blades

**GF 3190**

DE BAKEY

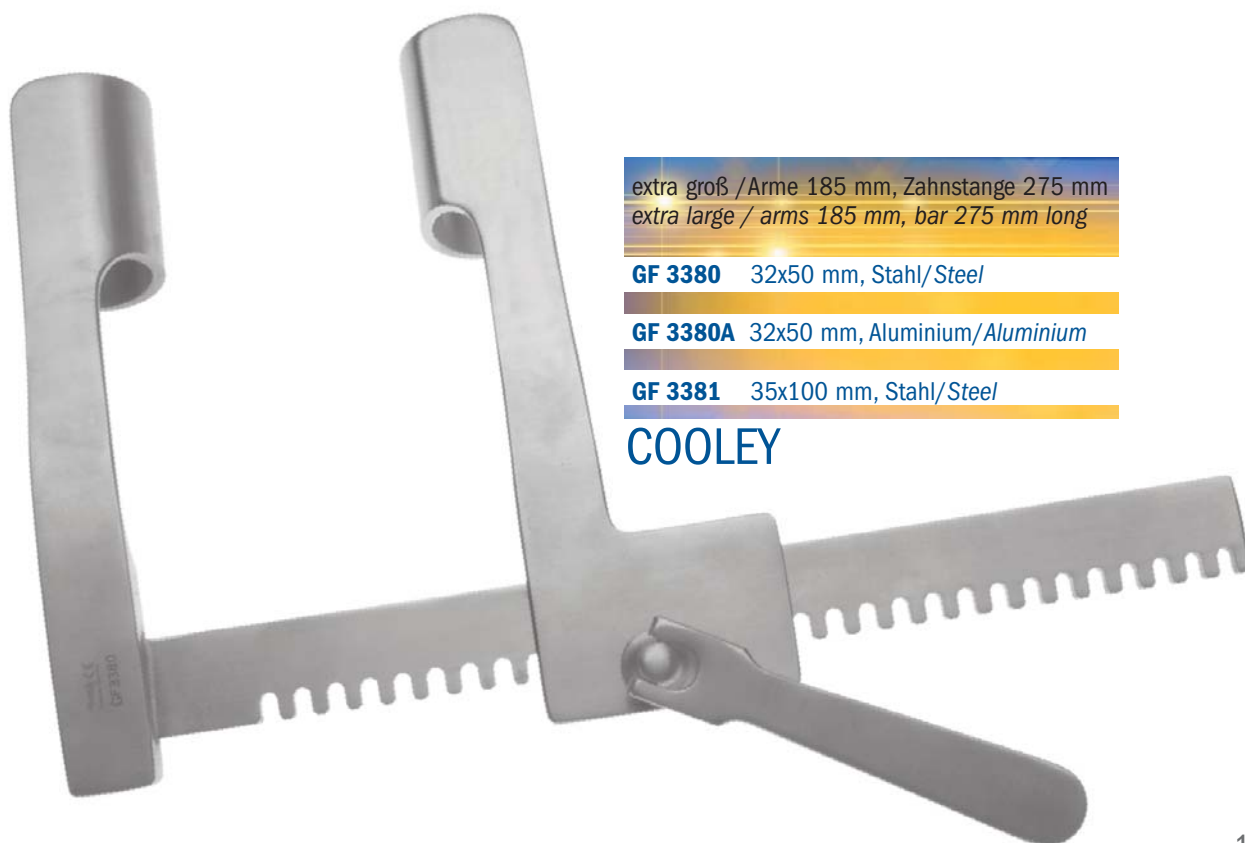

extra groß / Arme 185 mm, Zahnstange 275 mm  
extra large / arms 185 mm, bar 275 mm long

**GF 3380** 32x50 mm, Stahl/Steel

**GF 3380A** 32x50 mm, Aluminium/Aluminium

**GF 3381** 35x100 mm, Stahl/Steel

COOLEY



1 Paar Blätter allein /  
1 pair of blades only

**GF 3150** 30x30 mm

**GF 3160** 40x40 mm

**GF 3170** 50x50 mm



Sternum- und Rippensperrer  
komplett mit 3 Paar Blättern /  
Sternal retractor complete  
complete with 3 pairs of blades

**GF 3130**

**DE BAKEY**

komplett mit 2 Paar Blätter  
complete with 2 pcs Blades  
75x75 mm, 42x65 mm

**GF 3250**

**MERCEDES**

Schaftlänge 115 mm, 4½"  
shaft length 115 mm, 4½"

**MN 4591** gerade, 3 mm/straight, 3 mm

**MN 4592** 25° abgebogen/25° down turned

**MN 4593** 70° abgebogen/70° down turned

**MN 4594** 90° abgebogen/90° down turned

**MN 4598** 90° aufgebogen/90° upwards curved

**MN 4596** 45° links/45° left

**MN 4597** 45° rechts/45° right

## BAILEY RONGEUR

for Valve Surgery

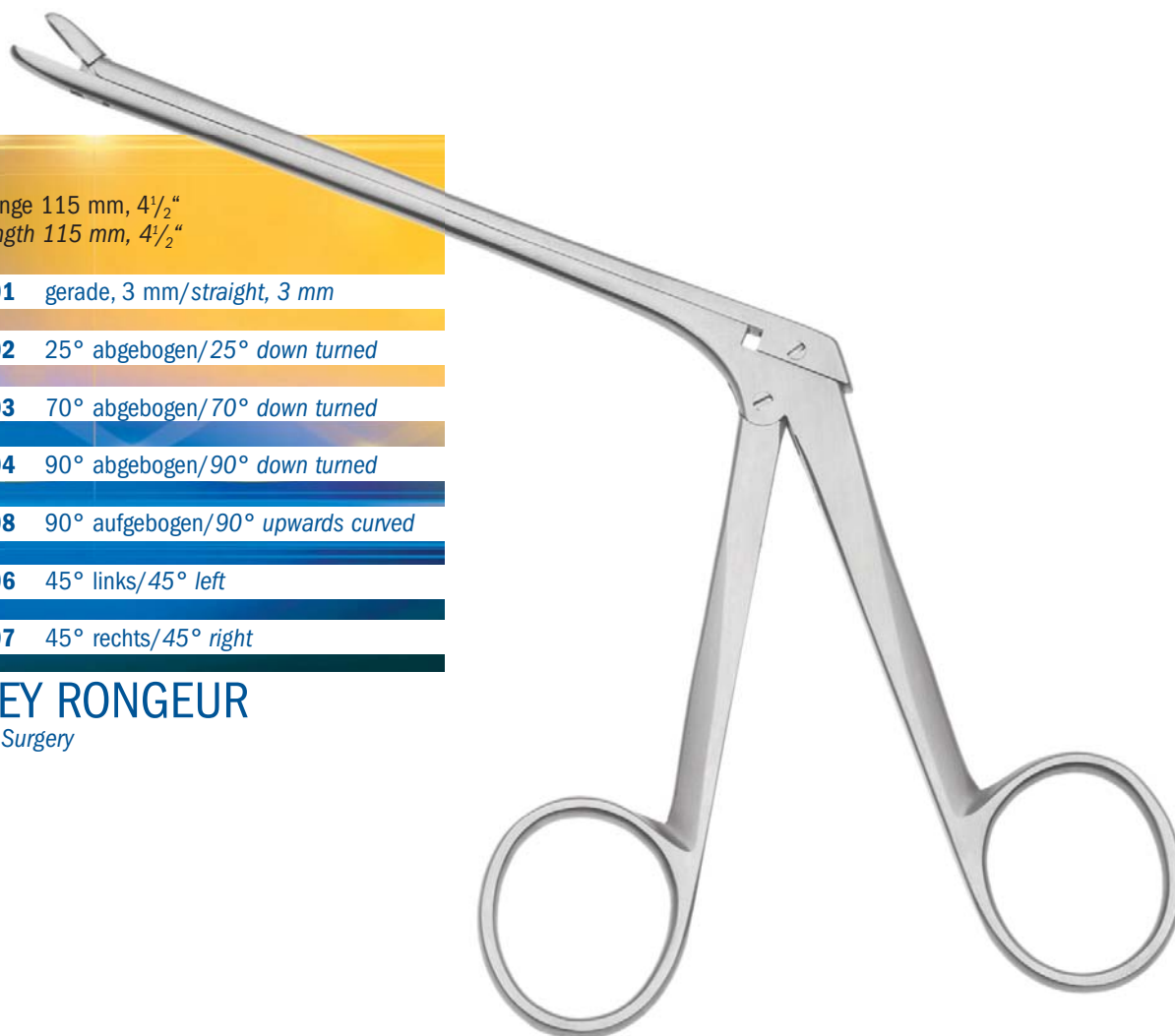



150 mm, 6" **GF 3350** BAILEY-BABY

180 mm, 7" **GF 3330** BAILEY

200 mm, 8" **GF 3340** BAILEY-GIBBON

**BAILEY**

<sup>1</sup>/<sub>2</sub>



Sternum Meissel  
*Sternal Chisel*

250 mm, 10" **GF 3630**

**LEBSCHE**

<sup>1</sup>/<sub>2</sub>



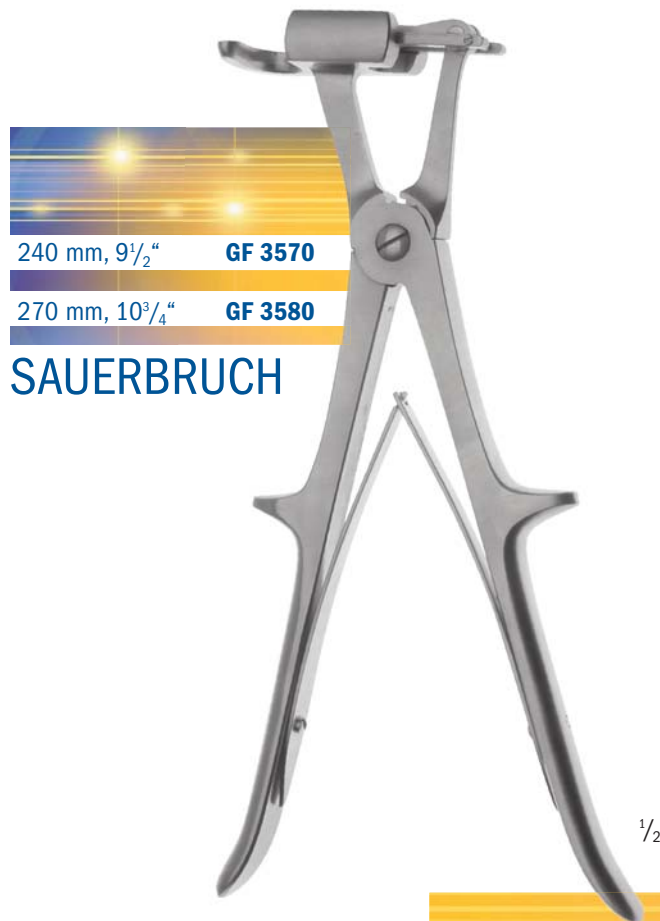



340 mm, 13 $\frac{1}{3}$ " **GF 3550**

**BETHUNE**

$\frac{1}{2}$

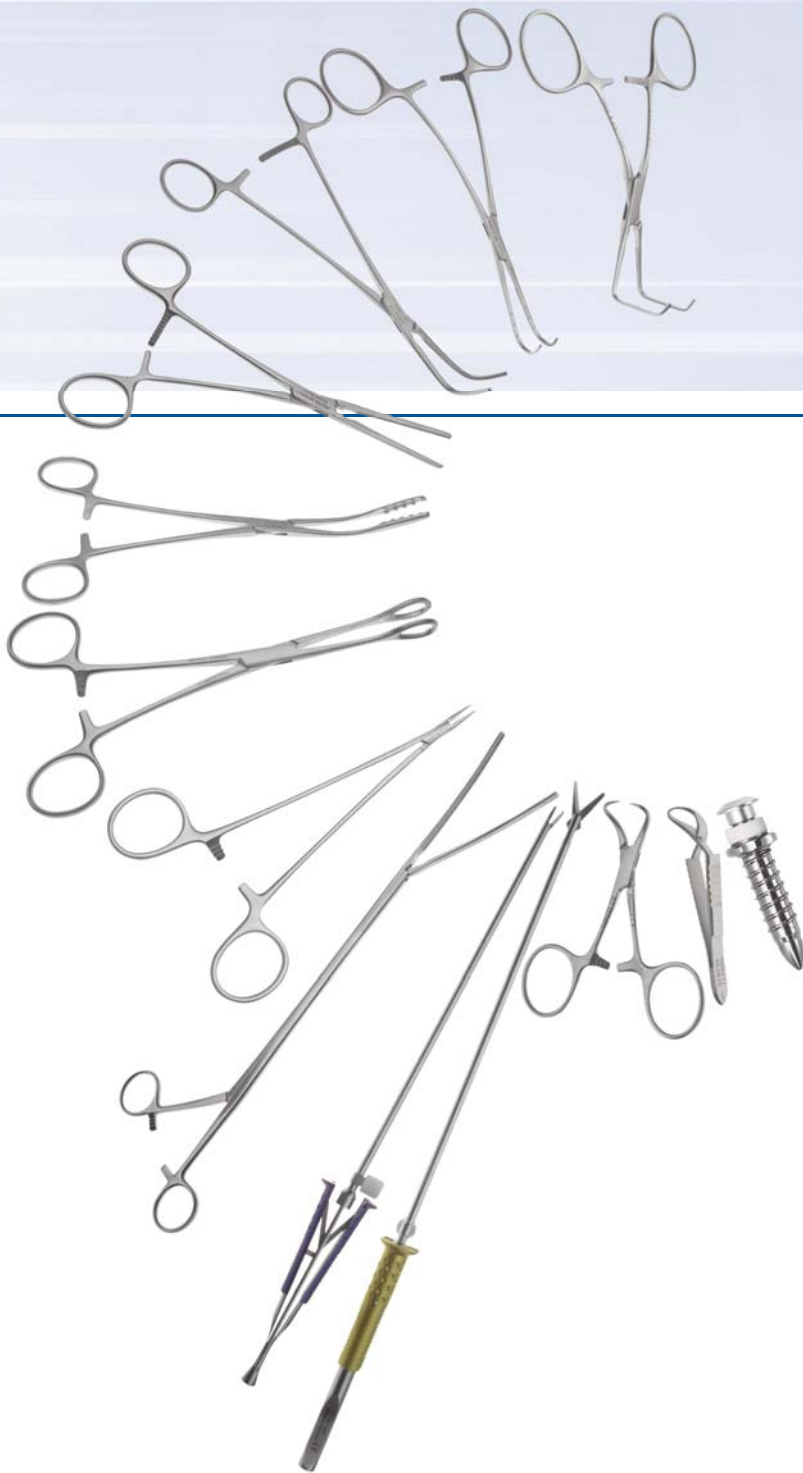

ATRAUMATISCHE  
GEFÄßKLEMMEN  
ATRAUMATIC  
VASCULAR CLAMPS

KLEMMEN ALLGEMEIN  
CLAMPS GENERAL

MIS INSTRUMENTE  
MIS INSTRUMENTS

PEN LINE  
PEN LINE

**DE BAKEY ZÄHNE**

Eine einseitige Einerreihe von feinst verarbeiteter Güte gewährleistet optimalen Schutz vor Gewebebeschädigungen und gleitet in eine Doppelreihe von Zähnen beim Schliessen ein.

**DE BAKEY JAWS**

A single row of finely serrated teeth opposing a double row, precisely crafted are designed to deliver the most minimal trauma to tissue.

**SPERREN**

Bieten feinste Klemmdruckeinstellungen für alle Anwender in der Herz-, Thorax- und Gefäßchirurgie. Je nach Klemmentyp werden die Sperren feinmechanisch auf gefühlvolle und sichere Rasterfunktion eingestellt.

Hier eingerichtet: 1 x 7, 1 x 9, 1 x 11 Schritten.

**RATCHETS**

Provide the finite control necessary in cardiovascular thoracic surgery. They are designed to furnish the precise increments of pressure designed.

Here furnished in 1 x 7, 1 x 9, 1 x 11 steps.

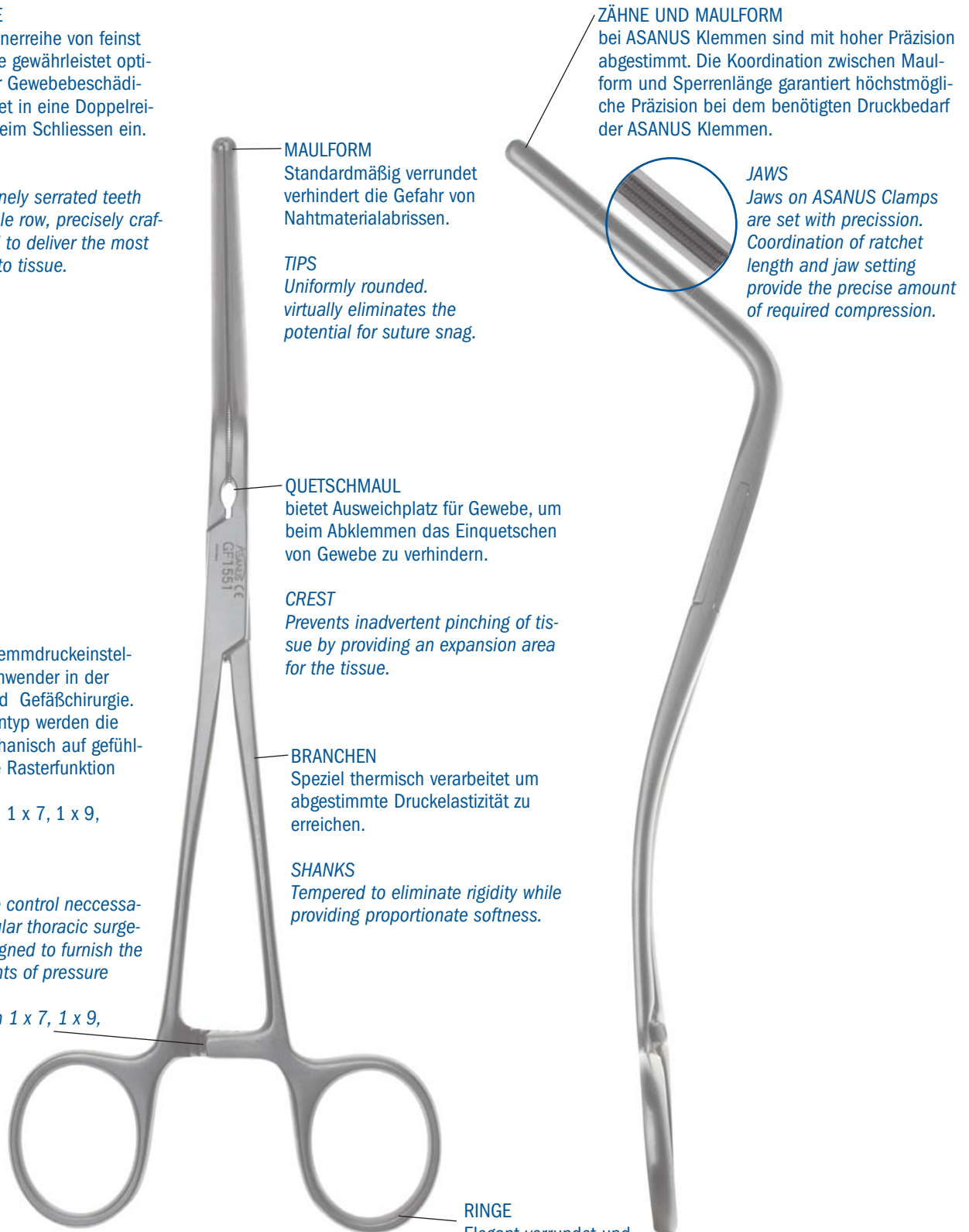

**MAULFORM**

Standardmäßig verrundet verhindert die Gefahr von Nahtmaterialabrissen.

**TIPS**

Uniformly rounded. virtually eliminates the potential for suture snag.

**QUETSCHMAUL**

bietet Ausweichplatz für Gewebe, um beim Abklemmen das Einquetschen von Gewebe zu verhindern.

**CREST**

Prevents inadvertent pinching of tissue by providing an expansion area for the tissue.

**BRANCHEN**

Speziell thermisch verarbeitet um abgestimmte Druckelastizität zu erreichen.

**SHANKS**

Tempered to eliminate rigidity while providing proportionate softness.

**ZÄHNE UND MAULFORM**

bei ASANUS Klemmen sind mit hoher Präzision abgestimmt. Die Koordination zwischen Maulform und Sperrenlänge garantiert höchstmögliche Präzision bei dem benötigten Druckbedarf der ASANUS Klemmen.

**JAWS**

Jaws on ASANUS Clamps are set with precision. Coordination of ratchet length and jaw setting provide the precise amount of required compression.

BEISPIEL  
Aortaklemme

EXAMPLE  
Aortic clamp

RINGE  
Elegant verrundet und auf die Chirurgenhände abgestimmt.

FINGER RINGS  
Comfortably sized.



**DE BAKEY Standard 1x2 Zahnreihen**  
Eine einreihige atraumatische Zahnung gleitet in eine gleichartige zweireihige Zahnung beim Schließen ein und fixiert die Gefäße atraumatisch mit einem temporären Gefäßverschluß sicher. Dieser Klemmentyp wird hauptsächlich aus Erfahrung für periphere Gefäß-, Aorta- und Aorta Teilverschlußklemmen verwendet.

### **DE BAKEY Standard**

*A single row of serrated teeth opposing a double row. The most commonly used jaw design, (and most imitated). Proven through many years' use at hospitals throughout the world, on adult peripheral vascular, aortic occlusion and partial occlusion clamps.*



**DE BAKEY kleine Zahnung**  
Ist eine Miniaturisierung der Original DE BAKEY atraumatischen Zahnung. Diese Zahnung wird häufig bei Bulldogklemmen aller Art, feinen Gefäßklemmen und einigen Kinderklemmen eingesetzt.

### **DE BAKEY Small Grip**

*A small version of the original DE BAKEY used on most bulldogs, vascular tissue forceps and numerous pediatric clamps.*



**DE BAKEY delikate Zahnung**  
für Kinder und Neugeborene  
Diese kleinstmögliche Mikro DE BAKEY Zahnung wird bei sehr vielen Neugeborenen und Kinderchirurgischen Eingriffen eingesetzt, als auch bei einigen peripheren Gefäßklemmarbeiten bei Erwachsenen.

### **DE BAKEY Extra Fine Grip**

*Pediatric  
The smallest size DE BAKEY being used on many new pediatric and adult peripheral vascular clamps, bulldogs and forceps.*

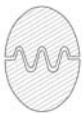

**DE BAKEY 2x3 Zahnreihen**  
Eine zweireihige auf dreireihige atraumatische Zahnung ist von der ursprünglichen Standard DE BAKEY Version für breite und kraftvolle atraumatische Klemmarbeiten entwickelt worden. Diese Zahnung wird hauptsächlich für große Aortacrossklemmen und bei verkalkten Arterien eingesetzt. Außerdem wird die Zahnung bei atraumatischen Klemmen für die Allgemein- und Viszeralchirurgie, sowie der Urologie, eingesetzt.

### **DE BAKEY 2x3**

*Double row of serrated teeth opposing a triple row: This modified version of DE BAKEY serration, having a broader clamping surface, is used on large clamps for aortic cross clamping and on diseased and calcified arteries. Clamps with the 2x3 serration are also used frequently in general surgery as bowel clamps.*



**COOLEY**  
Zwei aufeinander gegenüberliegende Klemmbacken in U-förmiger Verarbeitung bieten einen höchstmöglichen atraumatischen Klemmschutz. Insbesondere bei Neugeborenen und der Kinderchirurgie entstand dieser Zahntyp. Häufig wird die Zahnung auch für die Carotis und andere feine Gefäße im Erwachsenenbereich eingesetzt.

### **COOLEY**

*Two opposing rows of fine atraumatic teeth. Originally designed especially for surgery on infants and children the jaws grasp vessels firmly with less danger of crushing. Also available on a limited group of adult vascular clamps.*



**DERRA 1mm**  
Eine jeweils einreihige sich gegenüberliegende Klemmbackenanordnung in höchster Präzision von Chirurgiemechaniker-Spezialisten verarbeitet und für die Neonatale Gefäßchirurgie entwickelt, bietet sehr hohe präzise Klemmmöglichkeiten. Häufig wird dieser Klemmtyp auch in der Erwachsenen Chirurgie bei Carotis, femoralen und poplitealen Arterien und bei A. V. Fistulas, verwendet.

### **DERRA Pediatric 1mm**

*Single row of opposing teeth. The narrowest available vascular clamp. Designed for neonatal vascular surgery, these clamps have also proven of value in adult surgery of the carotid femoral and popliteal arteries and for creating A. V. Fistulas.*

 Pediatric 1 mm

**fein**  
**delicate**

gerade  
straight

30°

50°

90°

110 mm, 4<sup>3</sup>/<sub>8</sub>"

**GF 1293**

125 mm, 5"

**GF 1292**

130 mm, 5<sup>1</sup>/<sub>8</sub>"

**GF 1278**

**GF 1291**

## SHORT CASTANEDA

für präzisen Schließdruck mit minimaler Blockierung  
for precise, close-quarters control with minimal obstruction

 Pediatric 1 mm

150mm, 6"

**GF 2309**

**GF 2311**

**GF 2312**

## LONG CASTANEDA

 Pediatric 1 mm

150mm, 6"

**GF 2313**

## LONG

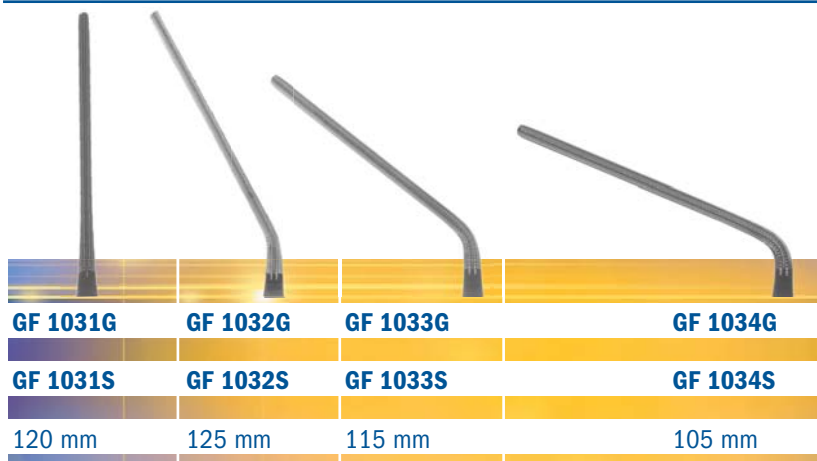

**DE BAKEY Extra Fine Grip Pediatric**

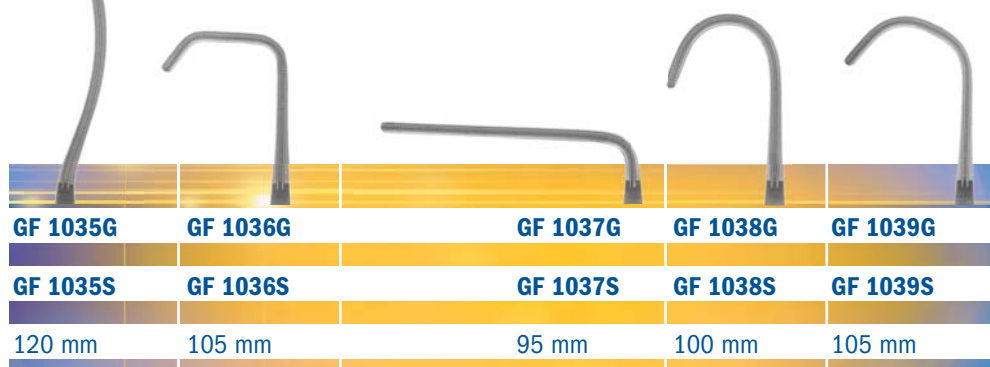

**DE BAKEY Extra Fine Grip Pediatric**

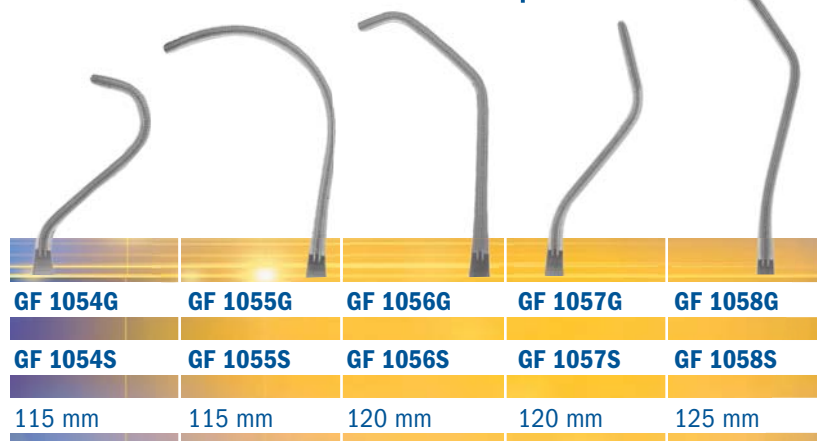

**DE BAKEY Extra Fine Grip Pediatric**

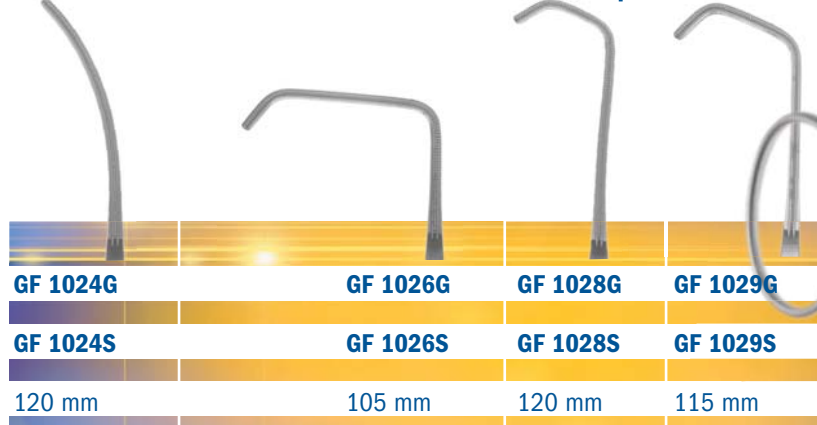

**DE BAKEY Extra Fine Grip Pediatric**

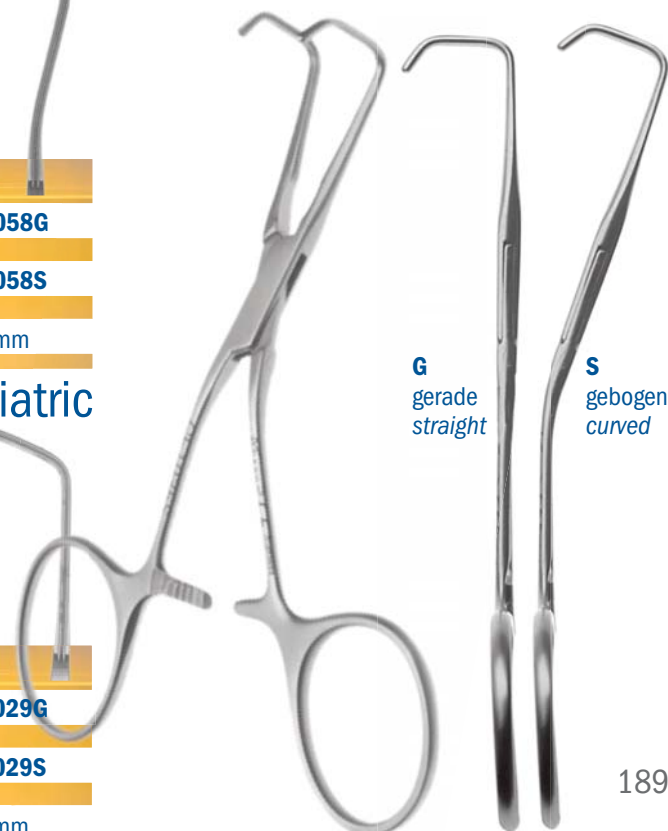

MEHRZWECKKLEMMEN FÜR DIE NEONATALCHIRURGIE  
VERSATILE, MULTIPURPOSE CLAMPS DESIGNED FOR NEONATAL USE

Pediatric 1 mm

**COOLEY**  
**Baby Vascular**

gerade  
straight

S-gebogen  
S-curved

125 mm, 5"

**GF 2658**

**GF 2659**

**TEALDI**

CAROTISKLEMMEN  
CAROTID CLAMPS

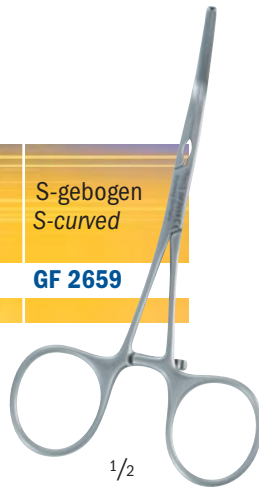

1/2

Pediatric 1 mm

**COOLEY**

135 mm, 5 1/4"

**GF 1062**

**CAROTIS**  
**DELICATE**



1/2

Pediatric 1 mm

Länge  
Length

Biegung  
bending

152 mm, 6"

slightly curved

**GF 1184**

**CASTANEDA**

EXTRA FEIN, EXTRA FINE



1/2

Pediatric 1 mm

Länge  
Length

Biegung  
bending

152 mm, 6"

slightly curved

**GF 1186**

**CASTANEDA**

EXTRA FEIN, EXTRA FINE



1/2



MEHRZWECK-GEFÄSSKLEMMEN  
 MULTIPURPOSE VASCULAR CLAMPS



DE BAKEY Extra Fine Grip Pediatric <sup>1/1</sup>

Länge Length	Biegung bending	Maullänge jaw length
-----------------	--------------------	-------------------------

146 mm, 5 3/4"	30°	20 mm
----------------	-----	-------



**GF 2101**

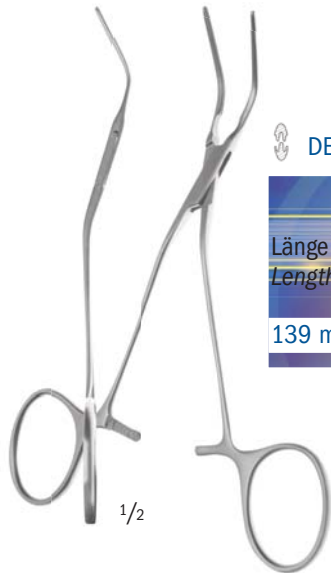

DE BAKEY Extra Fine Grip Pediatric <sup>1/1</sup>

Länge Length	Biegung bending	Maullänge jaw length
-----------------	--------------------	-------------------------

139 mm, 5 1/2"	45°	20 mm
----------------	-----	-------



**GF 2102**



DE BAKEY Extra Fine Grip Pediatric <sup>1/1</sup>

Länge Length	Biegung bending	Maullänge jaw length
-----------------	--------------------	-------------------------

136 mm, 5 3/8"	60°	20 mm
----------------	-----	-------

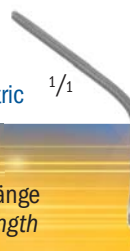

**GF 2103**

**DE BAKEY**  
 EXTRA FEIN, EXTRA FINE 1,5 MM

MEHRZWECK-GEFÄSSKLEMMEN  
MULTIPURPOSE VASCULAR CLAMPS



DE BAKEY Extra Fine Grip Pediatric <sup>1/1</sup>

Länge Length	Biegung bending	Maullänge jaw length
133 mm, 5 1/4"	90°	17 mm

**GF 2111**

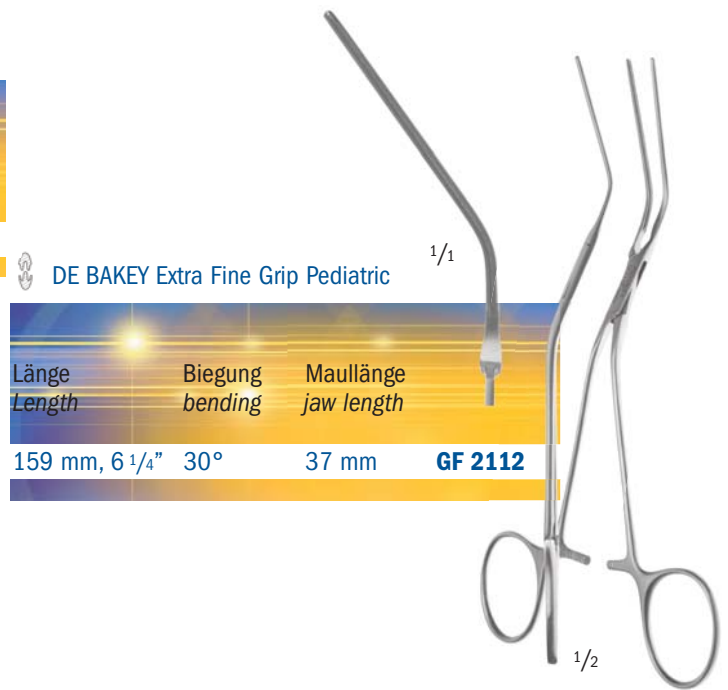

DE BAKEY Extra Fine Grip Pediatric <sup>1/1</sup>

Länge Length	Biegung bending	Maullänge jaw length
159 mm, 6 1/4"	30°	37 mm

**GF 2112**

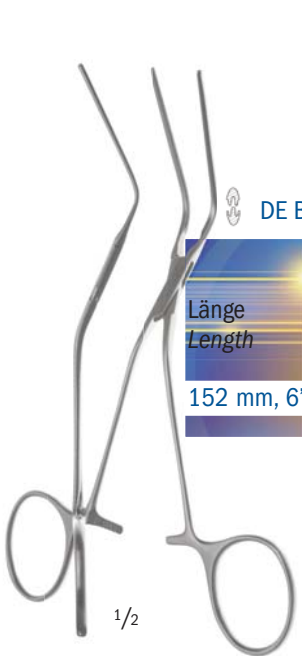

DE BAKEY Extra Fine Grip Pediatric <sup>1/1</sup>

Länge Length	Biegung bending	Maullänge jaw length
152 mm, 6"	45°	37 mm

**GF 2113**

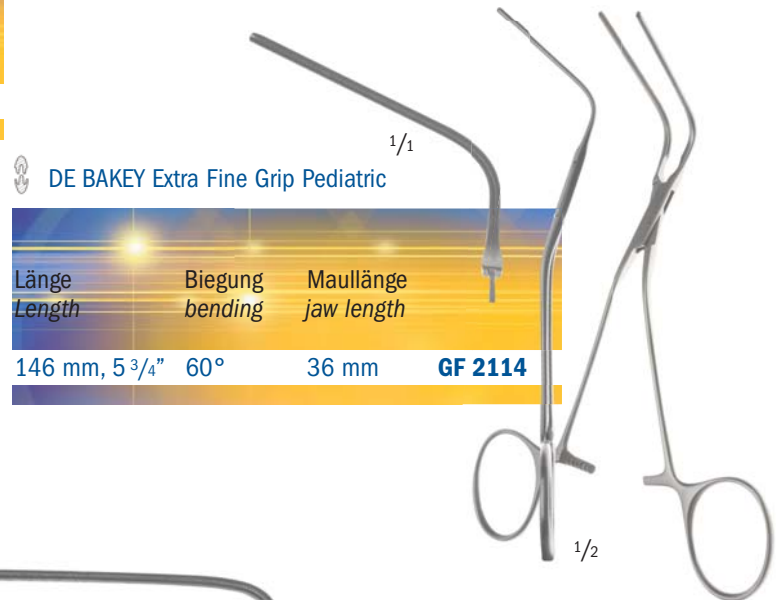

DE BAKEY Extra Fine Grip Pediatric <sup>1/1</sup>

Länge Length	Biegung bending	Maullänge jaw length
146 mm, 5 3/4"	60°	36 mm

**GF 2114**



DE BAKEY Extra Fine Grip Pediatric <sup>1/1</sup>

Länge Length	Biegung bending	Maullänge jaw length
133 mm, 5 1/4"	90°	37 mm

**GF 2115**

**DE BAKEY**  
EXTRA FEIN, EXTRA FINE 1,5 MM

KINDER- UND ERWACHSENEN GEFÄSSKLEMMEN  
 PEDIATRIC AND ADULT VASCULAR CLAMPS

DE BAKEY Extra Fine Grip Pediatric <sup>1/1</sup>

Länge Length	Biegung bending	Maullänge jaw length
98 mm, 3 7/8"	small 45°	15 mm

**GF 2139**

DE BAKEY Extra Fine Grip Pediatric <sup>1/1</sup>

Länge Length	Biegung bending	Maullänge jaw length
105 mm, 4 1/8"	medium 45°	30 mm

**GF 2141**

DE BAKEY Extra Fine Grip Pediatric <sup>1/1</sup>

Länge Length	Biegung bending	Maullänge jaw length
140 mm, 5 1/2"	large, straight	45 mm

**GF 2142**

DE BAKEY Extra Fine Grip Pediatric <sup>1/1</sup>

Länge Length	Biegung bending	Maullänge jaw length
133 mm, 5 1/4"	15°	40 mm

**GF 2143**

DE BAKEY Extra Fine Grip Pediatric <sup>1/1</sup>

Länge Length	Biegung bending	Maullänge jaw length
119 mm, 4 3/4"	45°	40 mm

**GF 2144**

**DE BAKEY**  
 EXTRA FEIN, EXTRA FINE 1,5 MM

DE BAKEY Extra Fine Grip Pediatric

Länge Length	Biegung bending	Maullänge jaw length	
111 mm, 4 3/8"	60°	40 mm	<b>GF 2145</b>
95 mm, 3 3/4"	90°	40 mm	<b>GF 2146</b>

**DE BAKEY**

KINDER- UND ERWACHSENEN GEFÄSSKLEMMEN  
PEDIATRIC AND ADULT VASCULAR CLAMPS  
EXTRA FEIN, EXTRA FINE 1,5 MM



DE BAKEY Extra Fine Grip Pediatric

Länge Length	Biegung bending	Maullänge jaw length	
152 mm, 6"	straight	25 mm	<b>GF 2147</b>



DE BAKEY Extra Fine Grip Pediatric

Länge Length	Biegung bending	Maullänge jaw length	
152 mm, 6"	20° angle shank	30 mm	<b>GF 2148</b>



DE BAKEY Extra Fine Grip Pediatric

Länge Length	Biegung bending	Maullänge jaw length	
152 mm, 6"	double angle jaw	30 mm	<b>GF 2149</b>



**DE BAKEY**  
PATENT DUCTUSKLEMMEN  
PATENT DUCTUS CLAMPS  
EXTRA FEIN, EXTRA FINE 1,5 MM

COARCTATIONSKLEMMEN  
 COARCTATION CLAMPS



DE BAKEY Extra Fine Grip Pediatric <sup>1/1</sup>

Länge Length	Biegung bending	Maullänge jaw length	
159 mm, 6 1/4"	straight	30 mm	<b>GF 2151</b>

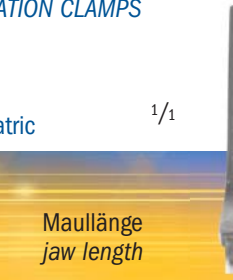

<sup>1/1</sup>

Länge Length	Biegung bending	Maullänge jaw length	
159 mm, 6 1/4"	angle shank	35 mm	<b>GF 2152</b>



DE BAKEY Extra Fine Grip Pediatric

<sup>1/2</sup>



DE BAKEY Extra Fine Grip Pediatric <sup>1/1</sup>

Länge Length	Biegung bending	Maullänge jaw length	
159 mm, 6 1/4"	15° angle jaw	32 mm	<b>GF 2153</b>



**DE BAKEY**

EXTRA FEIN, EXTRA FINE 1,5 MM

<sup>1/2</sup>



DE BAKEY Extra Fine Grip Pediatric <sup>1/1</sup>

Länge Length	Biegung bending	Maullänge jaw length	
152 mm, 6"	small spoon	20 mm	<b>GF 2154</b>
146 mm, 5 3/4"	small spoon, angled	20 mm	<b>GF 2155</b>



**DE BAKEY**

PHERIPHERALE GEFÄSSLÖFFELKLEMMEN  
 SPOON PERIPHERAL VASCULAR CLAMPS  
 EXTRA FEIN, EXTRA FINE 1,5 MM



<sup>1/2</sup>



1/2

 DE BAKEY Extra Fine Grip Pediatric

1/1

Länge Length	Biegung bending	Maullänge jaw length	
152 mm, 6"	large spoon	28 mm	<b>GF 2156</b>

## DE BAKEY

PHERIPHERALE GEFÄSSLÖFFELKLEMME  
SPOON PERIPHERAL VASCULAR CLAMP  
EXTRA FEIN, EXTRA FINE 1,5 MM

 DE BAKEY Extra Fine Grip Pediatric

1/1

Länge Length	Biegung bending	Maullänge jaw length	
171 mm, 6 1/4"	half circle	28 mm	<b>GF 2157</b>

## DE BAKEY

KINDERAORTAKLEMME  
PEDIATRIC AORTA CLAMP  
EXTRA FEIN, EXTRA FINE 1,5 MM



1/2

 DE BAKEY Extra Fine Grip Pediatric

1/1

Länge Length	Biegung bending	Maullänge jaw length	
119 mm, 4 11/16"	60° angle jaw	48 mm	<b>GF 2158</b>

## DE BAKEY

KINDERAORTAKLEMME  
REPLIGIE PEDIATRIC AORTA CLAMP  
EXTRA FEIN, EXTRA FINE 1,5 MM

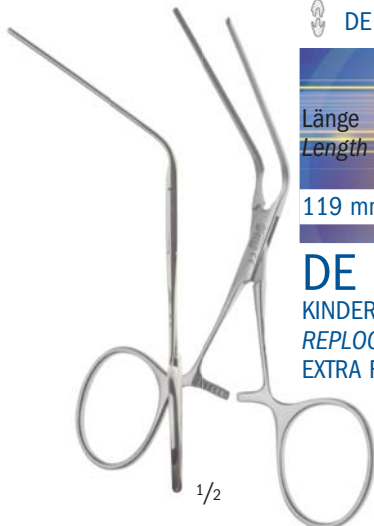

1/2



**DE BAKEY Extra Fine Grip Pediatric** <sup>1/1</sup>

Länge Length	Biegung bending	Maullänge jaw length	
156 mm, 6 1/8"	small jaw	40 mm	<b>GF 2161</b>
156 mm, 6 1/8"	large jaw	40 mm	<b>GF 2162</b>

**DE BAKEY**  
 SAPHENO-FEMORALIS KLEMME  
 MAINI SAPHENO-FEMORAL. JUNCTION CLAMPS  
 EXTRA FEIN, EXTRA FINE 1,5 MM

<sup>1/2</sup>



**DE BAKEY Extra Fine Grip Pediatric** <sup>1/1</sup>

Länge Length	Biegung bending	Maullänge jaw length	
120 mm, 4 3/4"	30° angle	30 mm	<b>GF 2163</b>
115 mm, 4 9/16"	50° angle	30 mm	<b>GF 2164</b>
95 mm, 3 3/4"	90° angle	30 mm	<b>GF 2165</b>

**DEBORAH-CASTANEDA**  
 PERIPHERALE GEFÄSSKLEM MEN  
 PERIPHERAL VASCULAR CLAMPS  
 EXTRA FEIN, EXTRA FINE 1,5 MM

<sup>1/2</sup>



DE BAKEY Extra Fine Grip Pediatric <sup>1/1</sup>

Länge Length	Biegung bending	Maullänge jaw length	
114 mm, 4 1/2"	small	26 mm	<b>GF 2166</b>

**DEBORAH-CASTANEDA**  
TANGENTIALKLEMME  
PARTIAL OCCLUSION CLAMP  
EXTRA FEIN, EXTRA FINE 1,5 MM

<sup>1/2</sup>

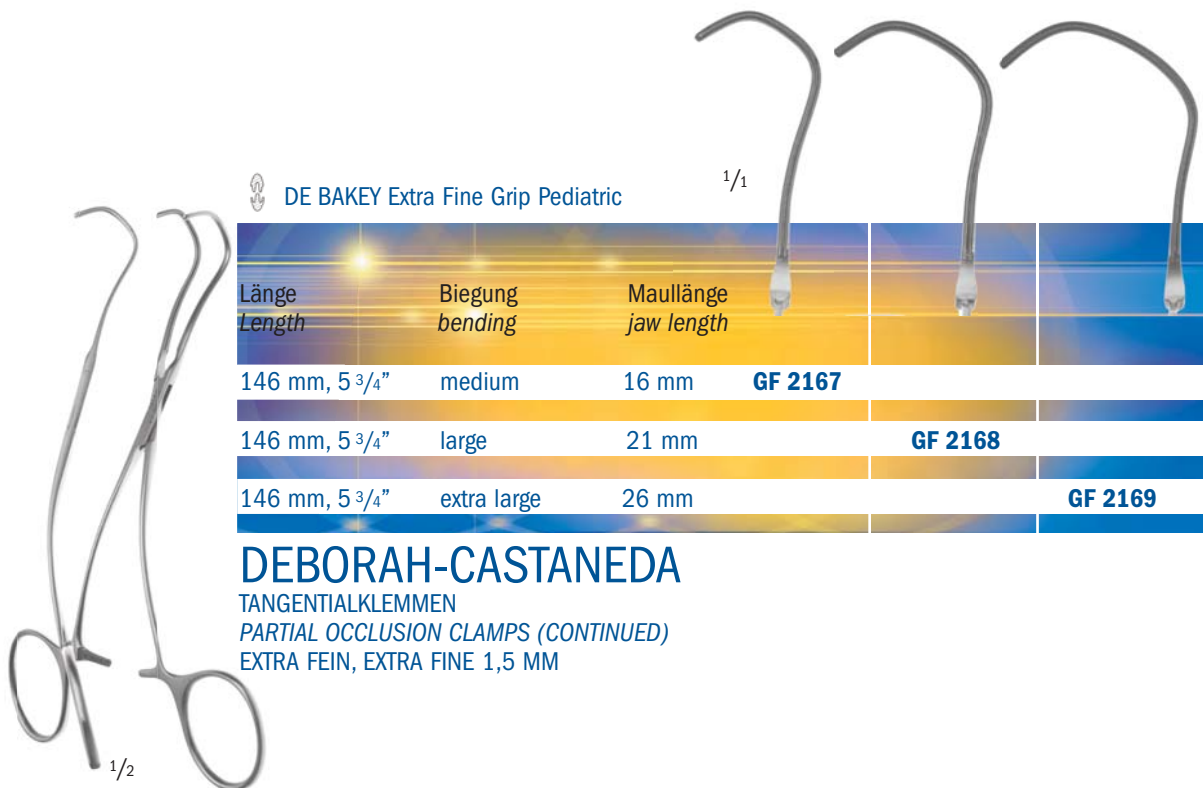

DE BAKEY Extra Fine Grip Pediatric <sup>1/1</sup>

Länge Length	Biegung bending	Maullänge jaw length	
146 mm, 5 3/4"	medium	16 mm	<b>GF 2167</b>
146 mm, 5 3/4"	large	21 mm	<b>GF 2168</b>
146 mm, 5 3/4"	extra large	26 mm	<b>GF 2169</b>

**DEBORAH-CASTANEDA**  
TANGENTIALKLEMMEN  
PARTIAL OCCLUSION CLAMPS (CONTINUED)  
EXTRA FEIN, EXTRA FINE 1,5 MM

<sup>1/2</sup>





DE BAKEY Extra Fine Grip Pediatric

Länge <i>Length</i>	Biegung <i>bending</i>	Maullänge <i>jaw length</i>	
114 mm, 4 1/2"	short, small	10 mm	<b>GF 2170</b>
111 mm, 4 3/8"	short, medium	16 mm	<b>GF 2171</b>

DERRA TANGENTIALKLEMMEN  
 DERRA PARTIAL OCCLUSION CLAMPS  
 EXTRA FEIN, EXTRA FINE 1,5 MM

TANGENTIALKLEMMEN  
DERRA PARTIAL OCCLUSION CLAMPS (CONTINUED)



DE BAKEY Extra Fine Grip Pediatric

1/1

Länge Length	Biegung bending	Maullänge jaw length
114 mm, 4 1/2"	short, large	28 mm

**GF 2172**



DE BAKEY Extra Fine Grip Pediatric

1/1

Länge Length	Biegung bending	Maullänge jaw length
117 mm, 4 5/8"	small, curved handle	17 mm

**GF 2173**

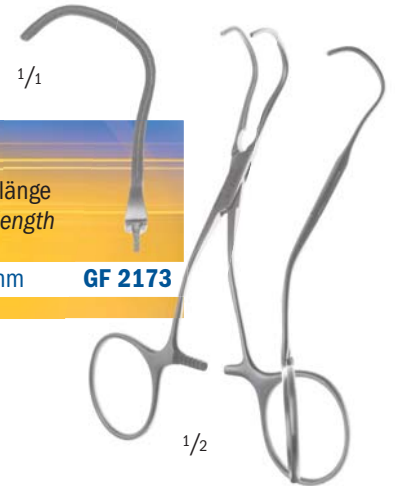

DE BAKEY Extra Fine Grip Pediatric

1/1

Länge Length	Biegung bending	Maullänge jaw length
120 mm, 4 3/4"	medium, curved handle	22 mm

**GF 2174**



DE BAKEY Extra Fine Grip Pediatric

1/1

Länge Length	Biegung bending	Maullänge jaw length
124 mm, 4 7/8"	large, curved handle	25 mm

**GF 2175**

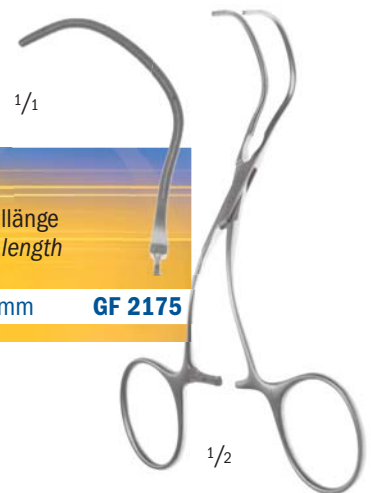

DE BAKEY Extra Fine Grip Pediatric

1/1

Länge Length	Biegung bending	Maullänge jaw length
152 mm, 6"	deep, small, curved handle	17 mm

**GF 2176**

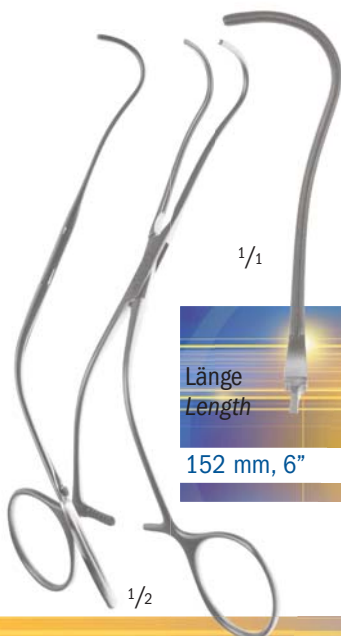

TANGENTIALKLEMMEN  
 DERRA PARTIAL OCCLUSION CLAMPS (CONTINUED)

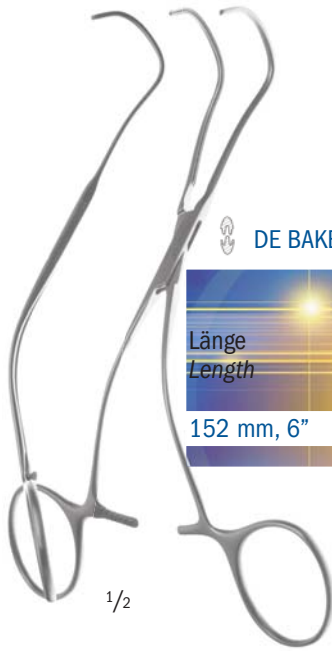

DE BAKEY Extra Fine Grip Pediatric

Länge Length	Biegung bending	Mauillänge jaw length
152 mm, 6"	deep, medium, curved handle	22 mm

**GF 2177**

1/1

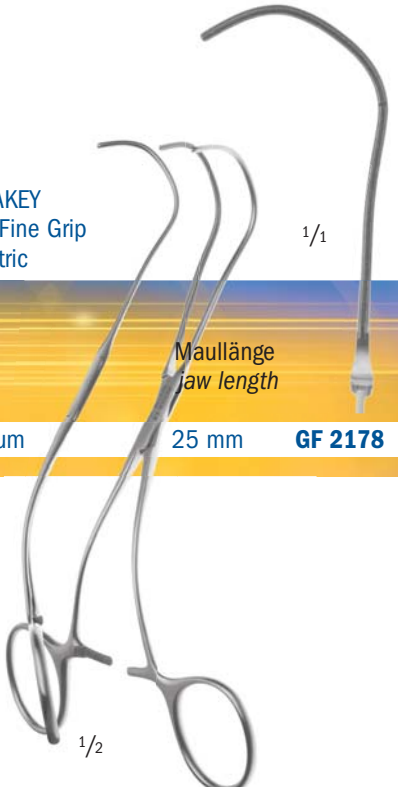

DE BAKEY Extra Fine Grip Pediatric

Länge Length	Biegung bending	Mauillänge jaw length
159 mm, 6 1/2"	deep, medium	25 mm

**GF 2178**

1/1



DE BAKEY Extra Fine Grip Pediatric

Länge Length	Biegung bending	Mauillänge jaw length
178 mm, 7"	deep, small	18 mm
178 mm, 7"	deep, medium	20 mm

**GF 2179**  
**GF 2181**

1/1

1/2

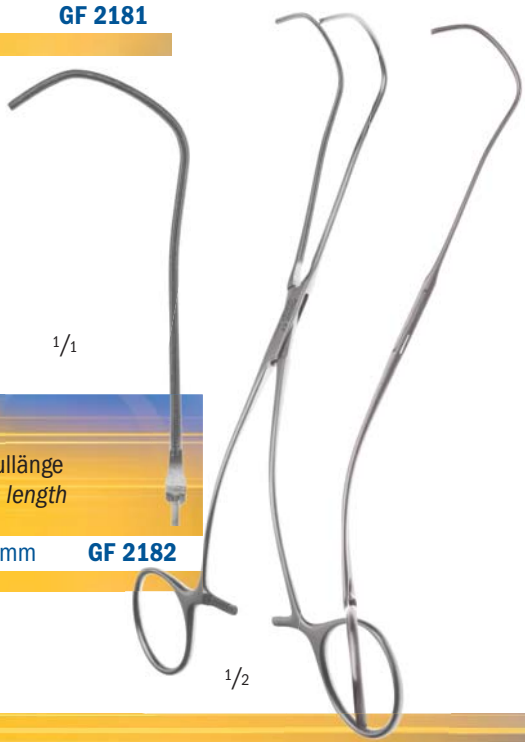

DE BAKEY Extra Fine Grip Pediatric

Länge Length	Biegung bending	Mauillänge jaw length
184 mm, 7 1/4"	deep, large	25 mm

**GF 2182**

1/1

1/2

EXTRA FEIN, EXTRA FINE 1,5 MM

TANGENTIALKLEMMEN  
PARTIAL OCCLUSION CLAMPS

DE BAKEY Extra Fine Grip Pediatric

Länge Length	Biegung bending	Mauillänge jaw length
114 mm, 4 1/2"	small	13 mm

GF 2183

DE BAKEY Extra Fine Grip Pediatric

Länge Length	Biegung bending	Mauillänge jaw length
114 mm, 4 1/2"	medium	20 mm

GF 2184

DE BAKEY Extra Fine Grip Pediatric

Länge Length	Biegung bending	Mauillänge jaw length
114 mm, 4 1/2"	large	24 mm

GF 2185

DE BAKEY Extra Fine Grip Pediatric

Länge Length	Biegung bending	Mauillänge jaw length
165 mm, 6 1/2"	small	15 mm

GF 2186

**DE BAKEY**  
EXTRA FEIN, EXTRA FINE 1,5 MM

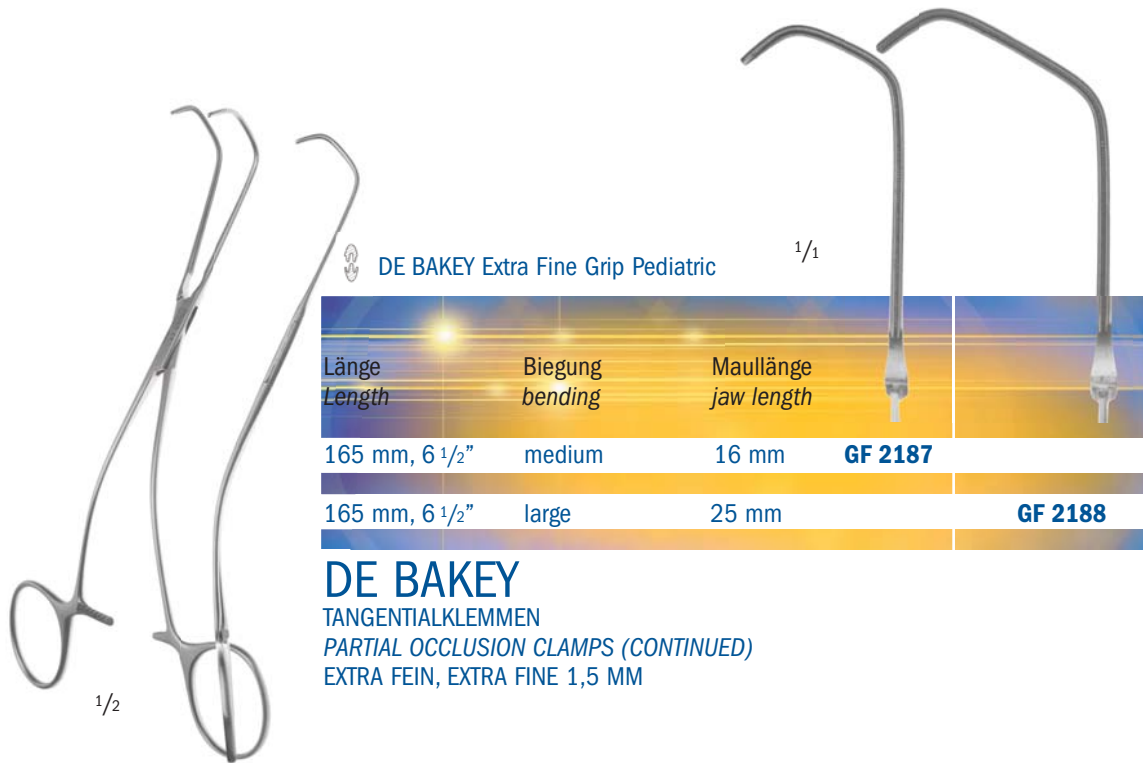

DE BAKEY Extra Fine Grip Pediatric

Länge Length	Biegung bending	Maullänge jaw length	
165 mm, 6 1/2"	medium	16 mm	<b>GF 2187</b>
165 mm, 6 1/2"	large	25 mm	<b>GF 2188</b>

**DE BAKEY**  
TANGENTIALKLEMMEN  
PARTIAL OCCLUSION CLAMPS (CONTINUED)  
EXTRA FEIN, EXTRA FINE 1,5 MM



COOLEY

Länge Length	Maullänge jaw length	
171 mm, 6 3/4"	17 mm	<b>GF 2191</b>

**COOLEY**  
ANASTOMOSENKLEMME  
ANASTOMOSIS CLAMP  
EXTRA FEIN, EXTRA FINE 1,5 MM

NEONATAL RENALKLEMMEN  
CLINIC BABY RENAL CLAMPS



DE BAKEY Extra Fine Grip Pediatric

Länge Length	Biegung bending	
149 mm, 5 7/8"	left	<b>GF 2192</b>

**CLEVELAND**  
EXTRA FEIN, EXTRA FINE 1,5 MM

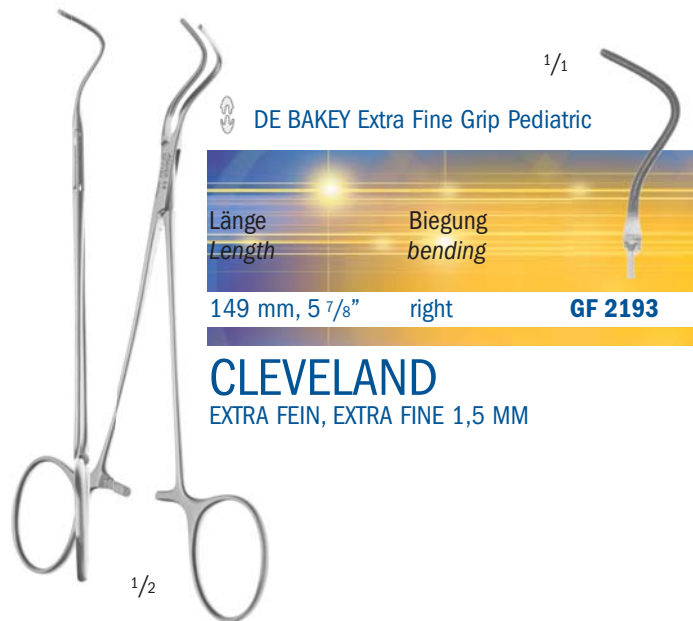

DE BAKEY Extra Fine Grip Pediatric

Länge Length	Biegung bending	
149 mm, 5 7/8"	right	<b>GF 2193</b>

**CLEVELAND**  
EXTRA FEIN, EXTRA FINE 1,5 MM

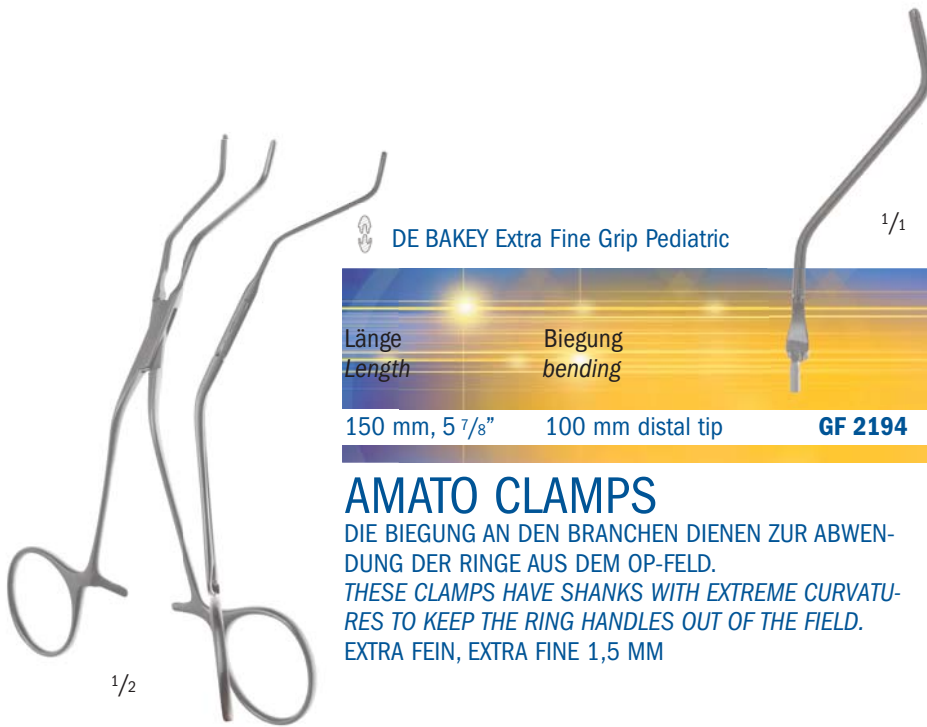

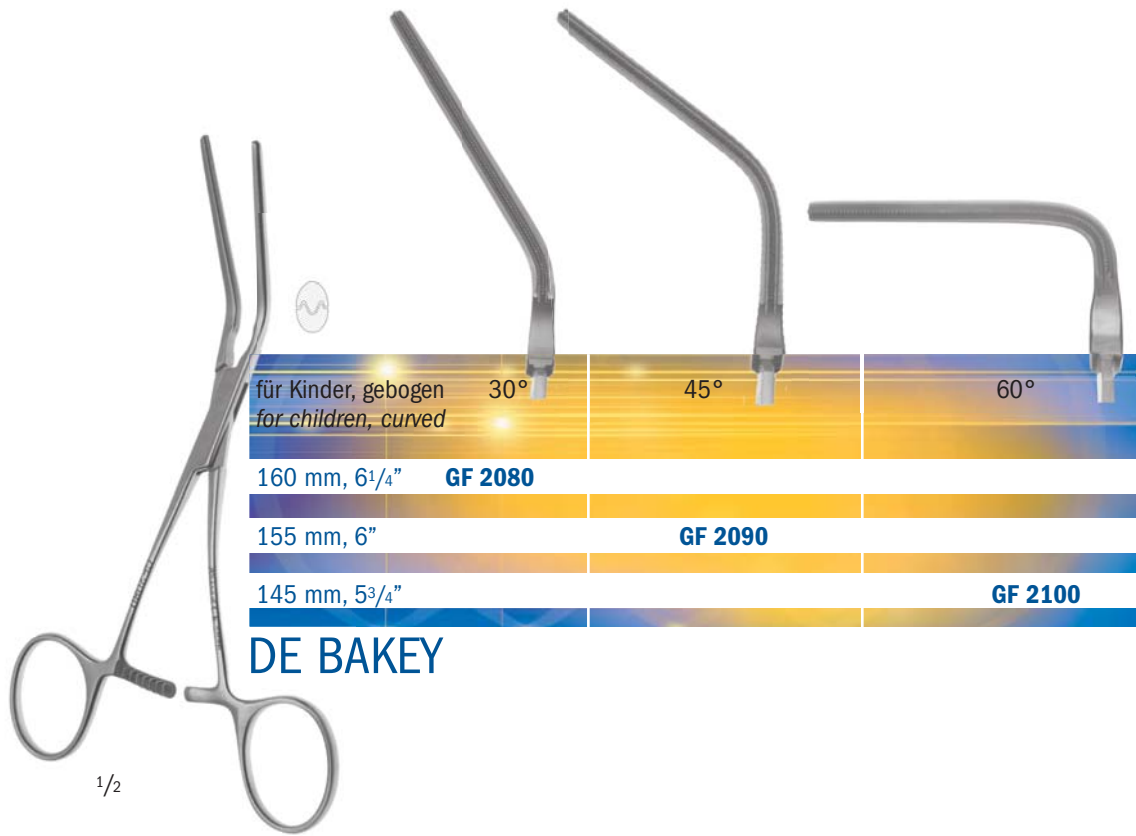



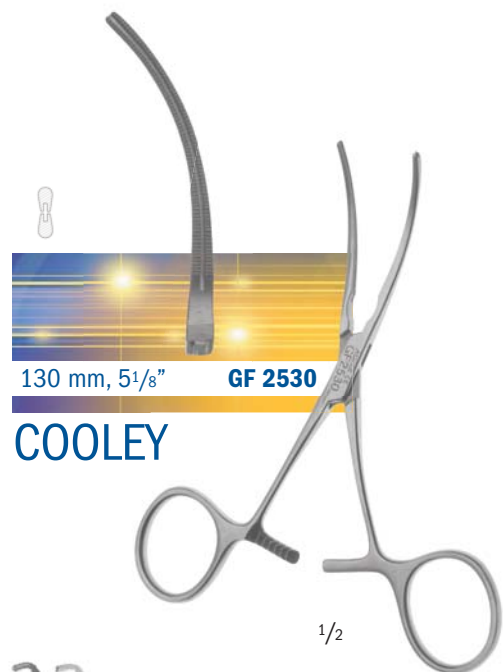
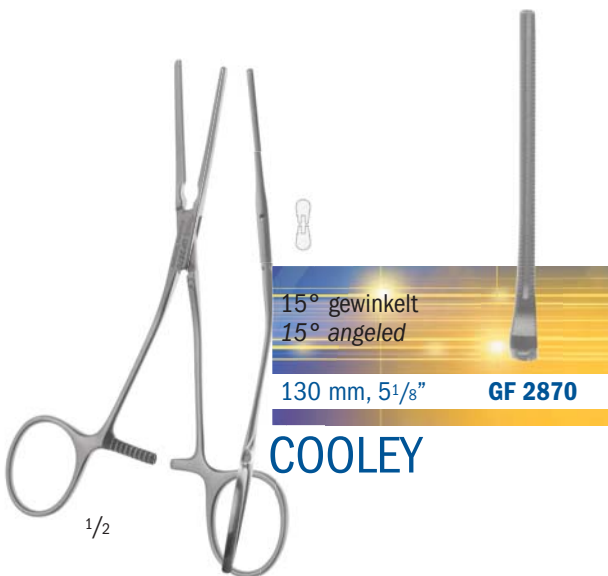
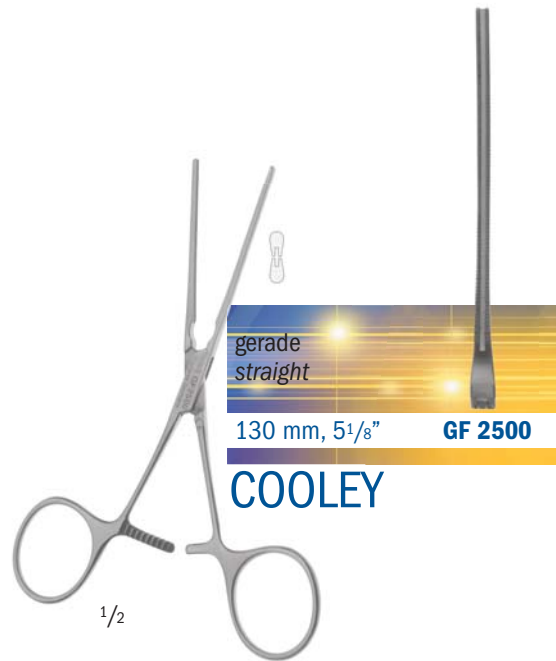
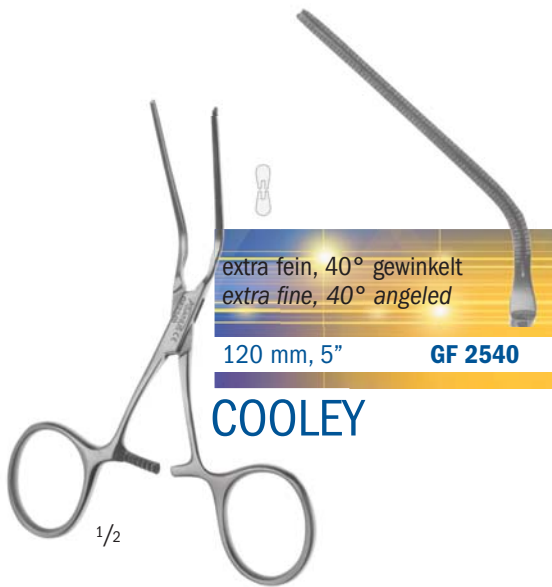

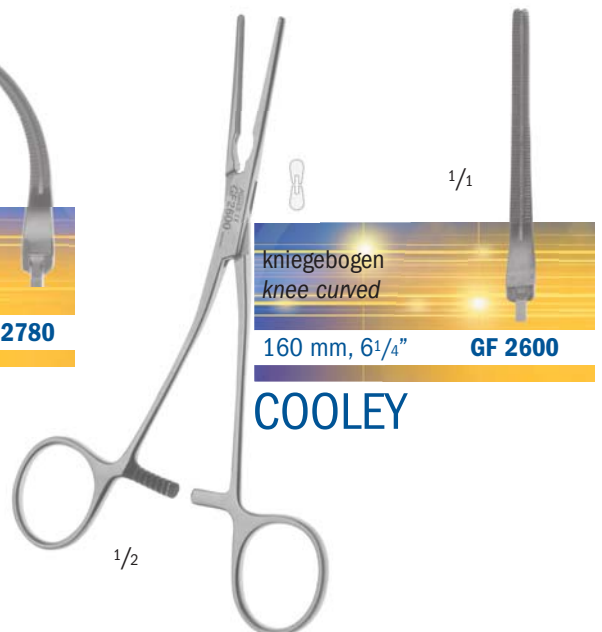
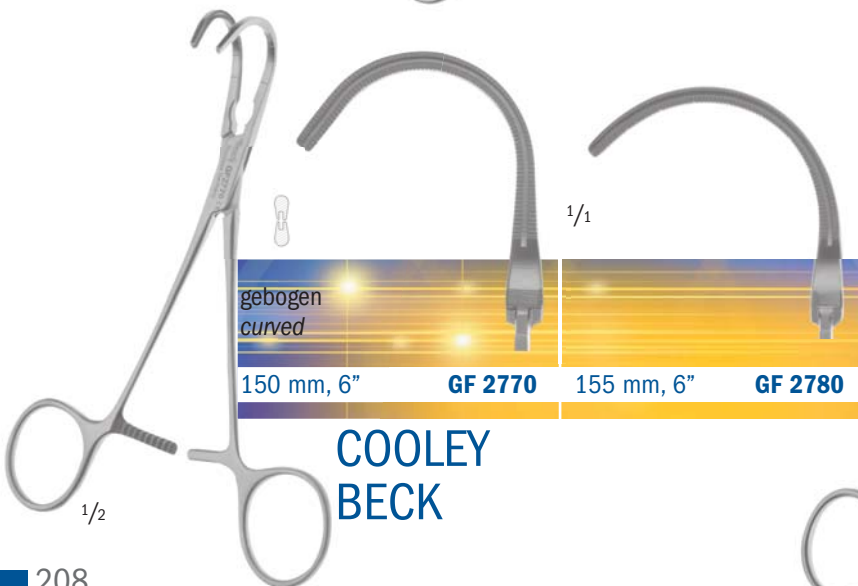
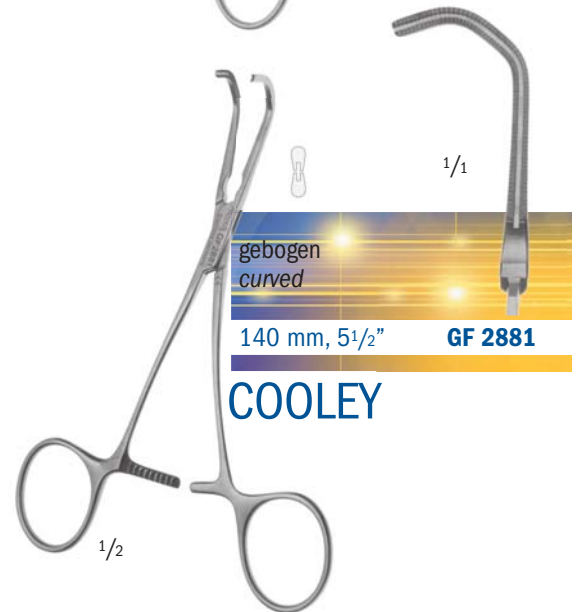
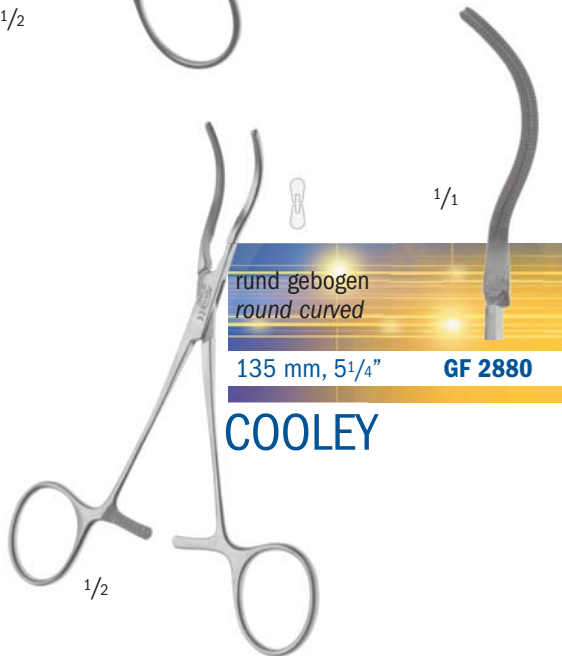
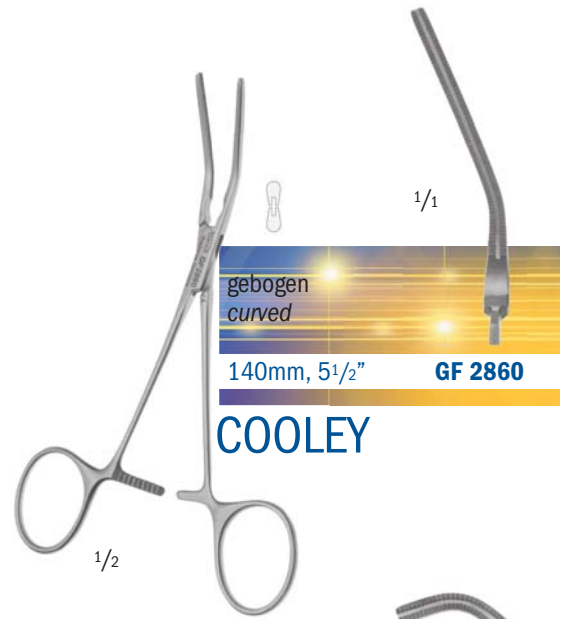
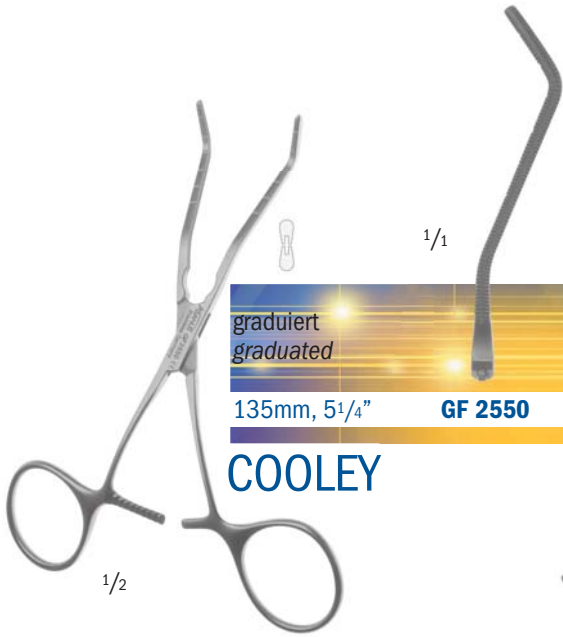

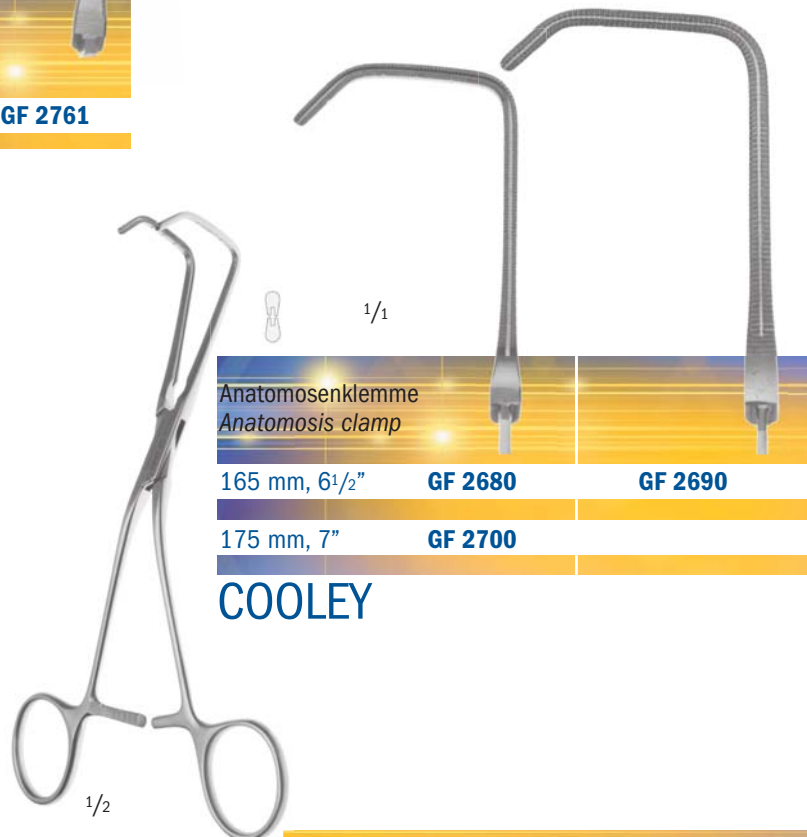
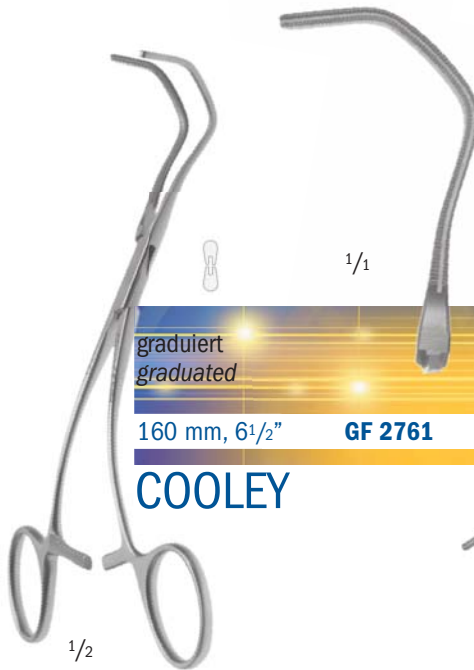
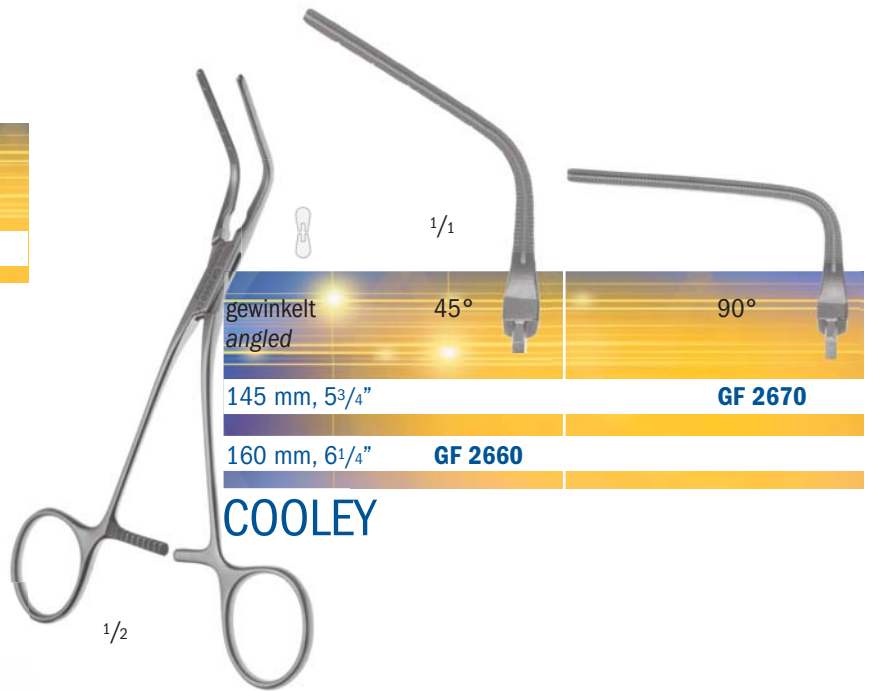
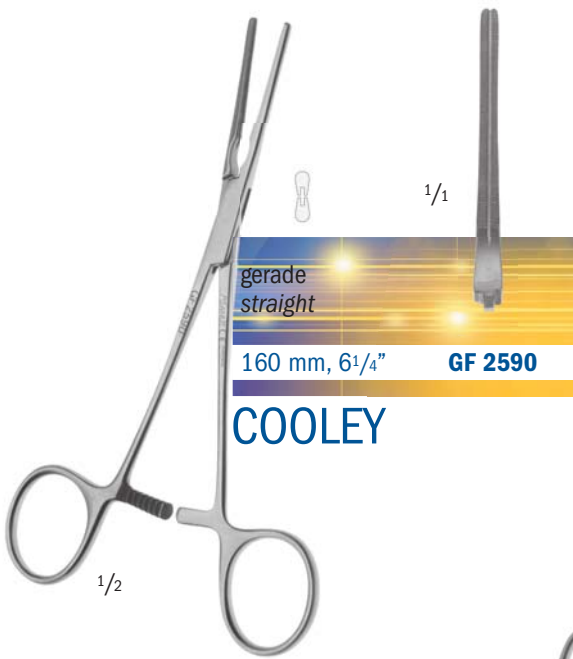

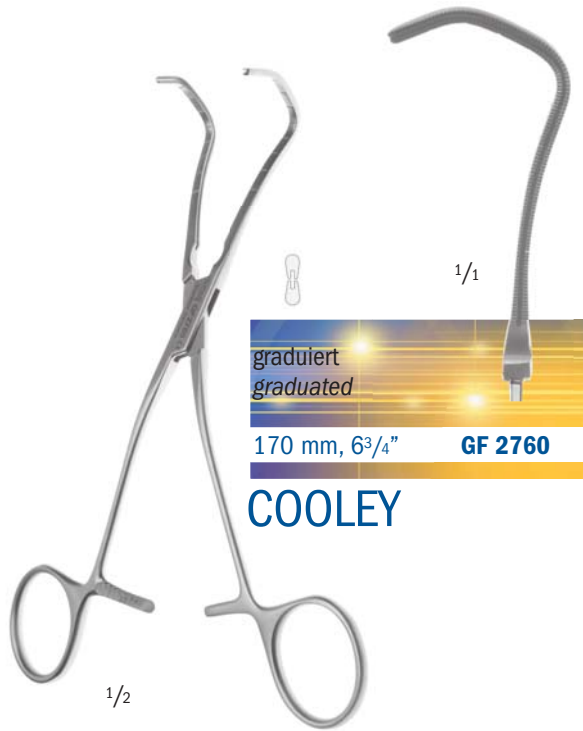

 DE BAKEY Extra Fine Grip Pediatric

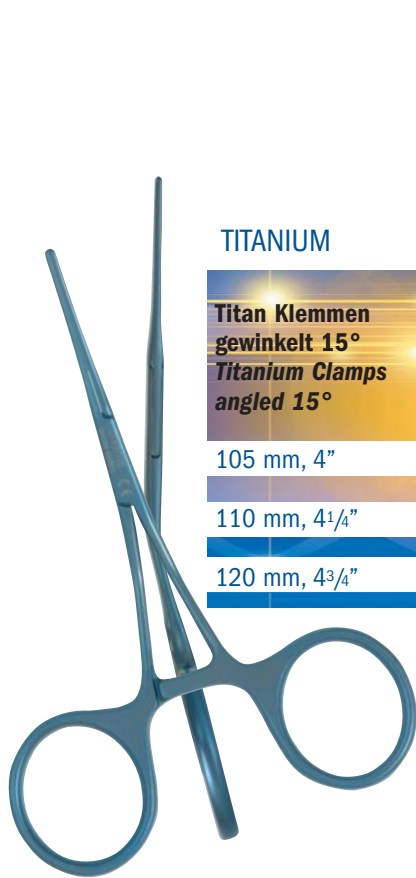

TITANIUM

<b>Titan Klemmen gewinkelt 15° Titanium Clamps angled 15°</b>	24 mm gerade 24 mm straight	45° gewinkelt 45° angled 24 mm	60° gewinkelt 60° angled	5 mm 5 mm	9 mm 9 mm
	105 mm, 4"	GFK 8019		GFK 8020	
110 mm, 4 <sup>1</sup> / <sub>4</sub> "	GFK 8018			GFK 8022	
120 mm, 4 <sup>3</sup> / <sub>4</sub> "	GFK 8017				

MICRO PEDRIATIC DE BAKEY

 DE BAKEY Extra Fine Grip Pediatric

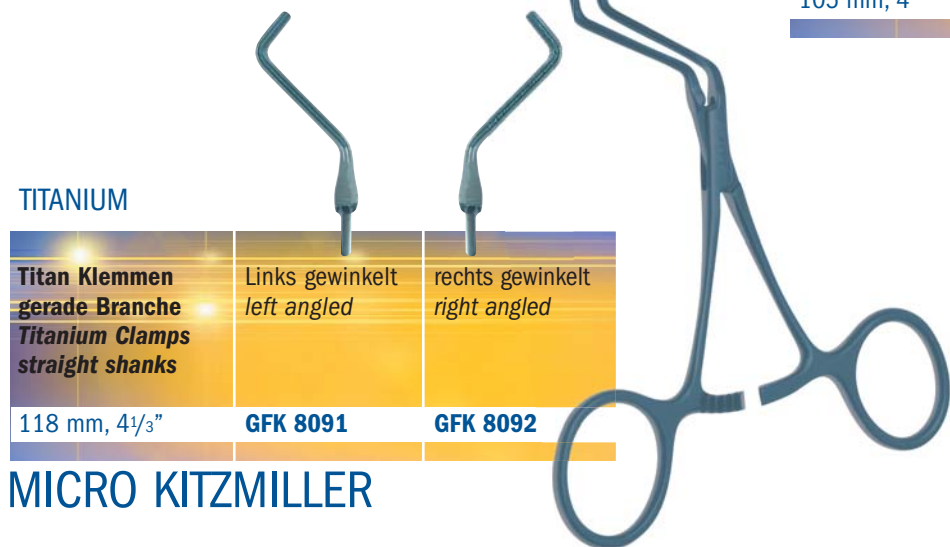

TITANIUM

<b>Titan Klemmen gerade Branche Titanium Clamps straight shanks</b>	Links gewinkelt left angled	rechts gewinkelt right angled
	118 mm, 4 <sup>1</sup> / <sub>3</sub> "	GFK 8091

<b>Titan Klemmen gerade Titanium Clamps straight</b>	6 mm Löffelmaul 6 mm Spoon Jaws
105 mm, 4"	GFK 8021

MICRO KITZMILLER



TITANIUM

205 mm, 8<sup>1</sup>/<sub>4</sub>" **GFK 8400**

**LAMBERT-KAY  
COOLEY**

1/2

TITANIUM

1/1

gewinkelt  
angled

30°

60°

90°

150 mm, 6"

**GFK 8053**

160 mm, 6<sup>1</sup>/<sub>4</sub>"

**GFK 8052**

170 mm, 6<sup>3</sup>/<sub>4</sub>"

**GFK 8051**

**COOLEY**

TITANIUM

1/1

Fig.1

Fig.2

Fig.3

165 mm, 6<sup>1</sup>/<sub>2</sub>"

**GFK 8054**

170 mm, 6<sup>3</sup>/<sub>4</sub>"

**GFK 8055**

180 mm, 7"

**GFK 8056**

**DERRA DE BAKEY**

1/2

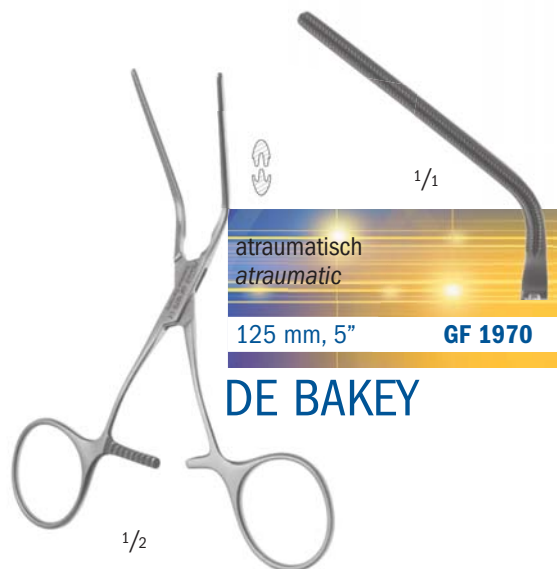
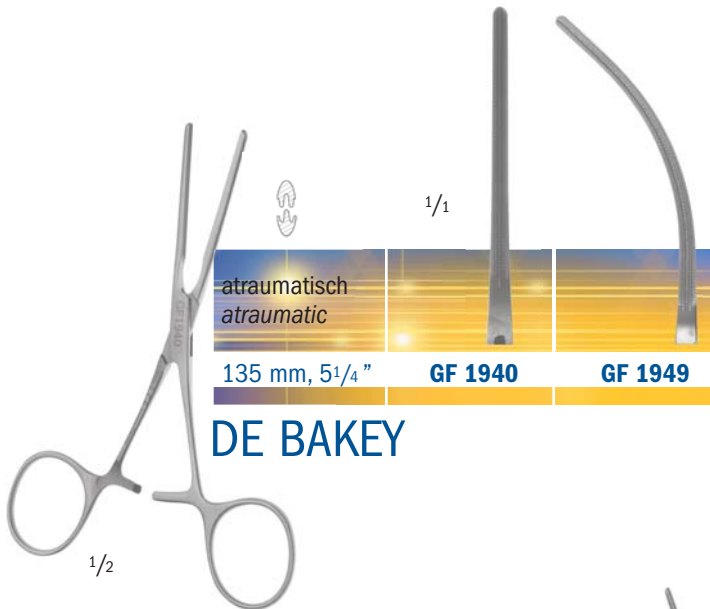
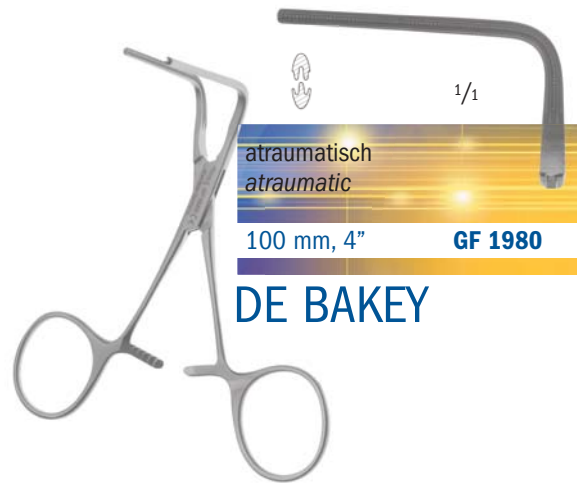



**GREGORY  
PROFUNDA**

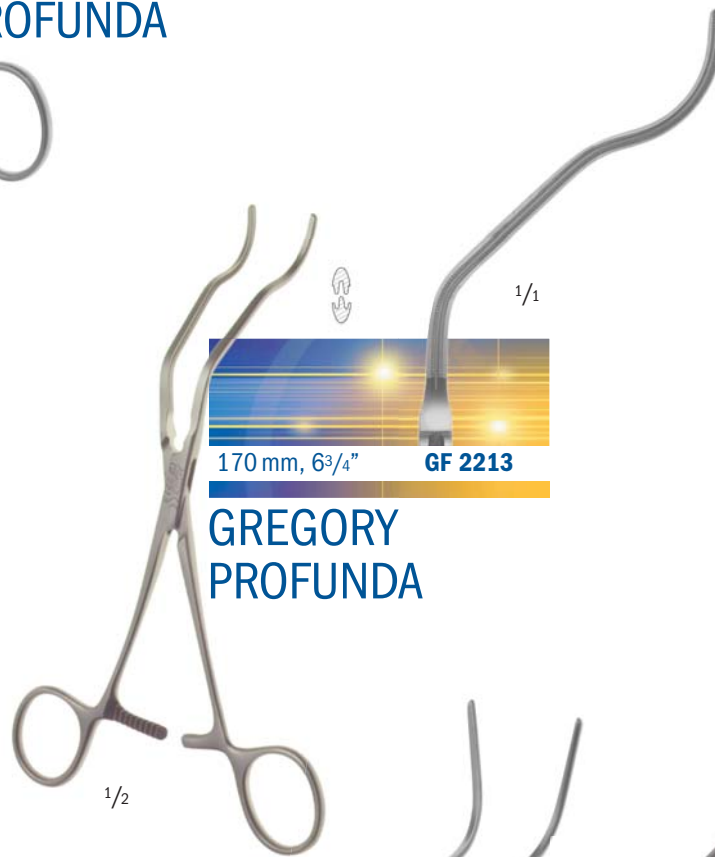

**GREGORY  
PROFUNDA**

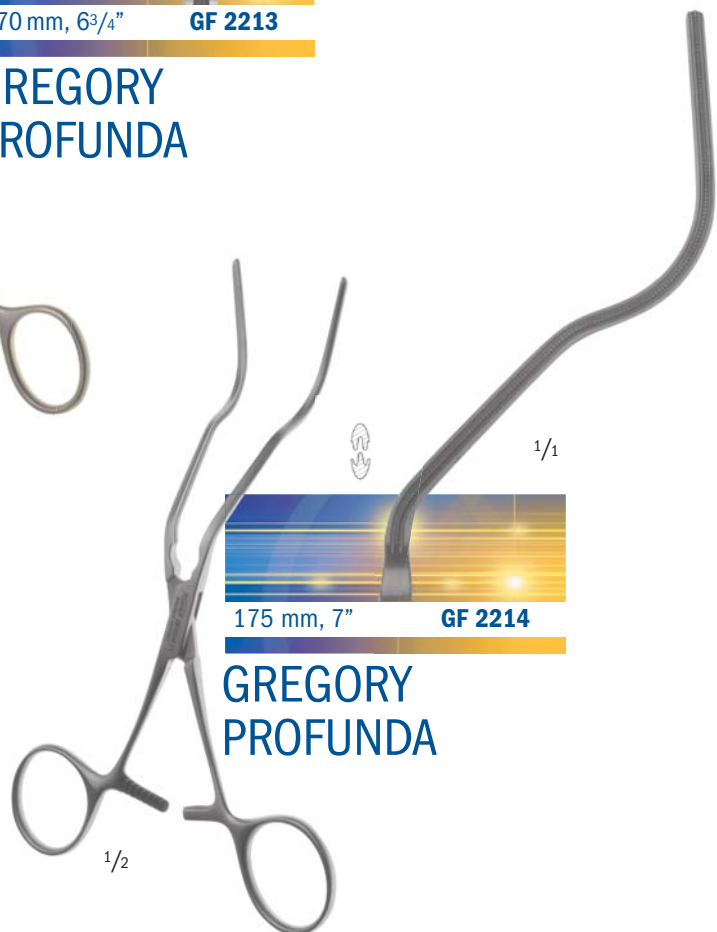

**GREGORY  
PROFUNDA**



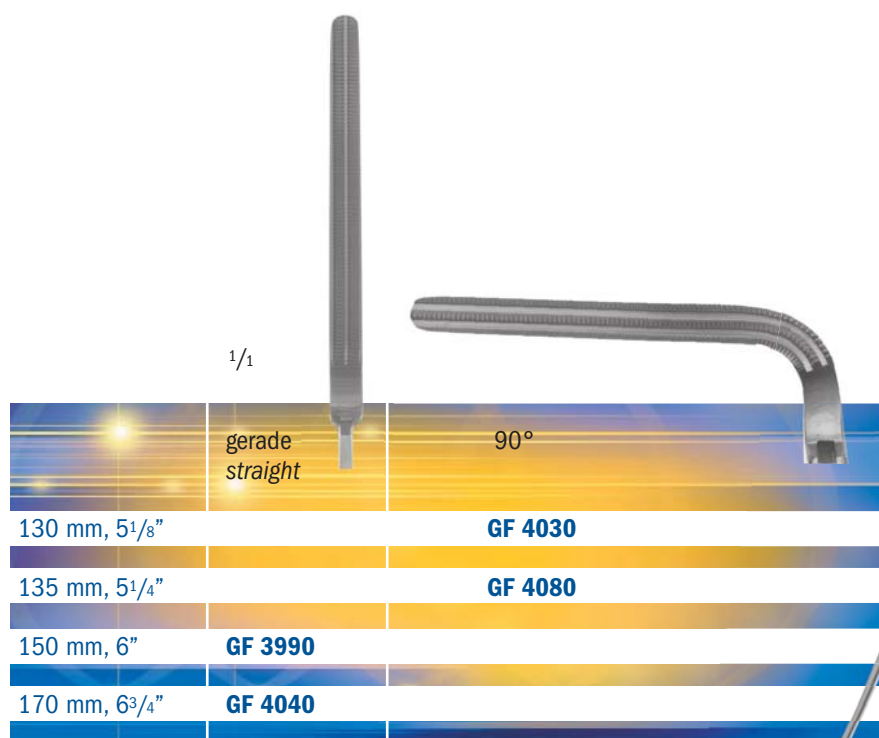

## DARDIK

PERIPHERALKLEMMEN soft elastisch  
 PERIPHERAL VASCULAR CLAMPS soft elastic

Die DARDIK Maulform ist eine 2 x 3 ineinander liegende atraumatische Zahnung.

Die Maulform ist sehr flach gehalten, um eine optimale Elastizität beim Klemmen zu erzielen.

Diese Klemme wird häufig bei stark erkrankten, geschwächten und brüchigen Gefäßen, sowie in der Urologie, eingesetzt.

*DARDIK serration type consist of 2 x 3 serrations with a flat thin elastic clamp form.*

*These type of clamps are been often used for strong defects of vessels and in the urology surgery.*

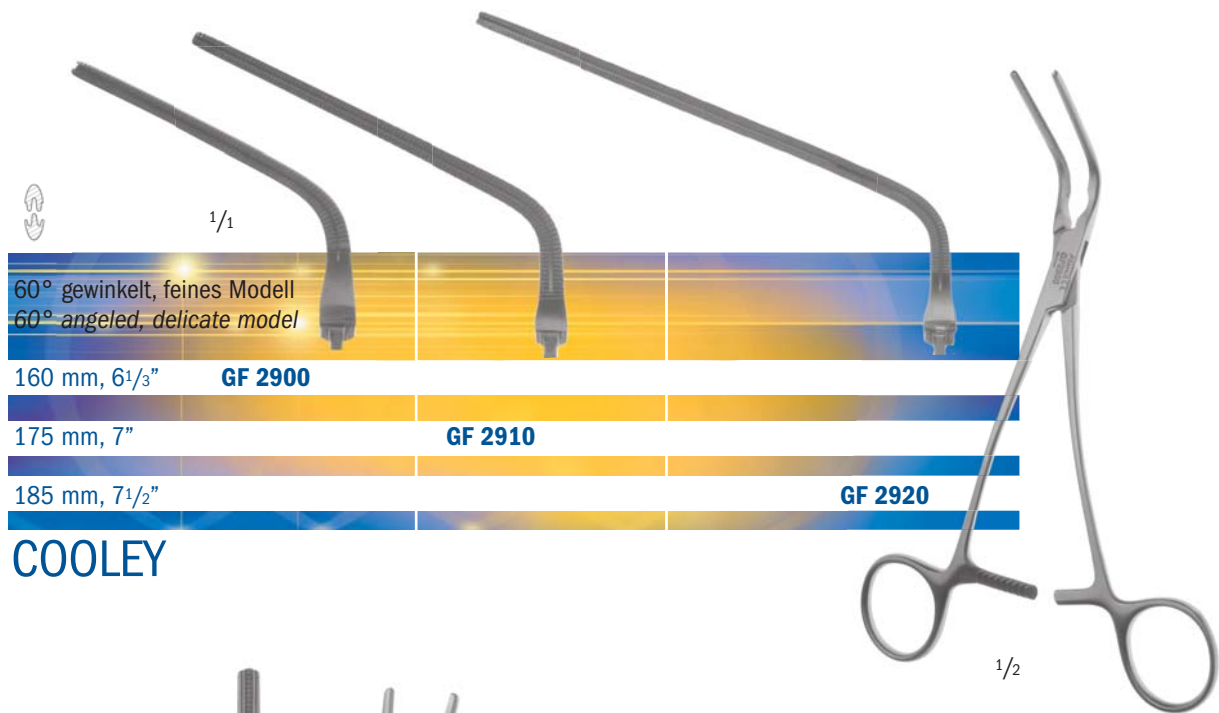

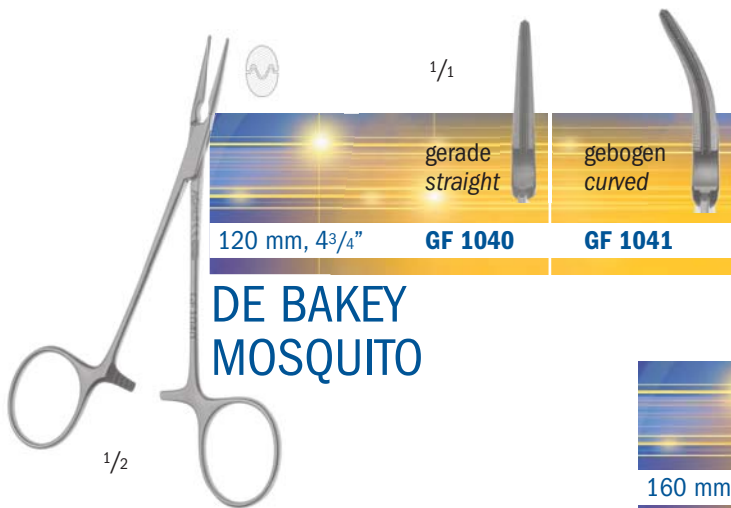

**DE BAKEY  
MOSQUITO**



**DE BAKEY  
RANKIN**

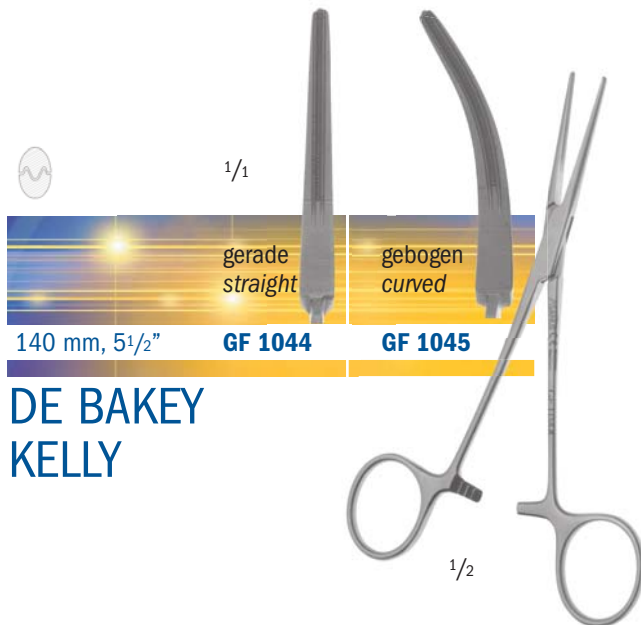

**DE BAKEY  
KELLY**

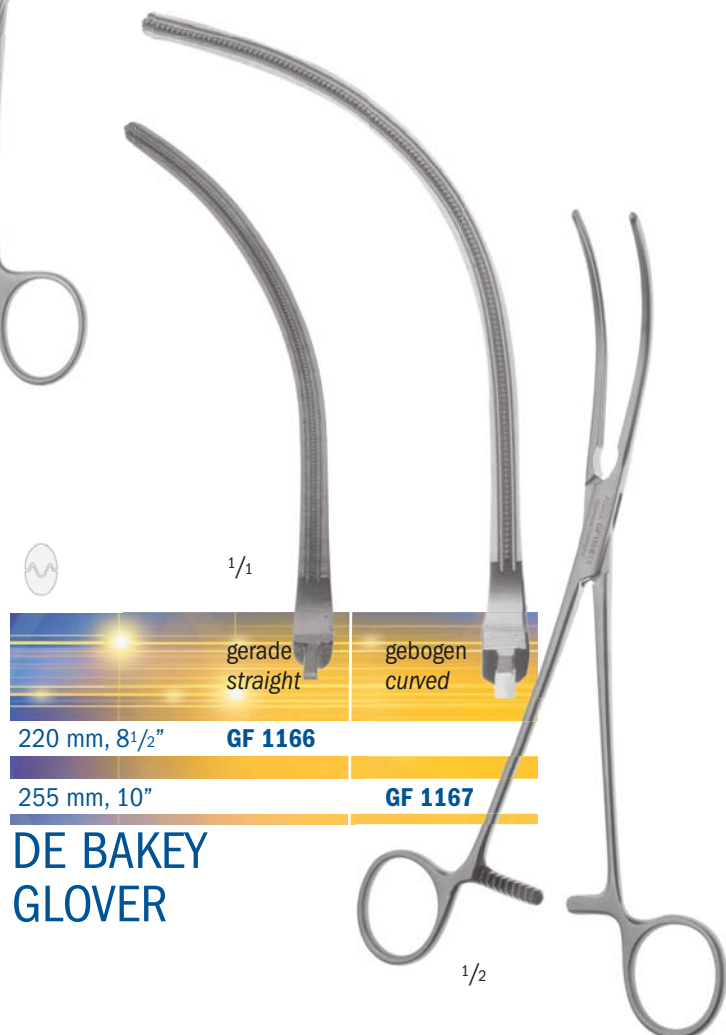

**DE BAKEY  
GLOVER**



1/1

gerade  
straight

170 mm, 6<sup>3</sup>/<sub>4</sub>"

**GF 2610**

**COOLEY**



1/2



1/1

gebogen  
curved

170 mm, 6<sup>3</sup>/<sub>4</sub>"

**GF 2615**

**COOLEY**

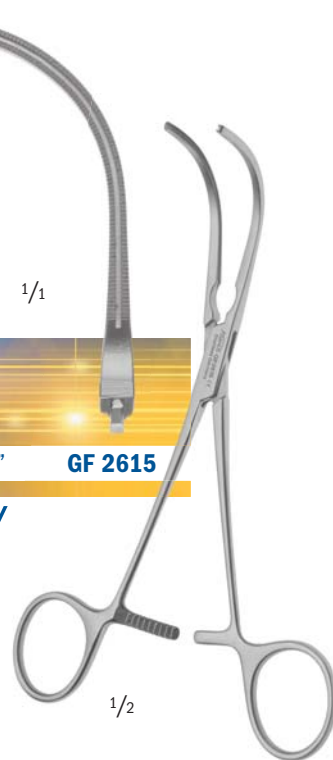

1/2



1/1

gerade  
straight

165 mm, 6<sup>1</sup>/<sub>2</sub>"

**GF 1048**

185 mm, 7<sup>1</sup>/<sub>4</sub>"

**GF 1052**

205 mm, 8"

**GF 1850**

260 mm, 10<sup>1</sup>/<sub>4</sub>"

**GF 1900**

285 mm, 11"

**GF 1920**

**DE BAKEY  
PEAN**

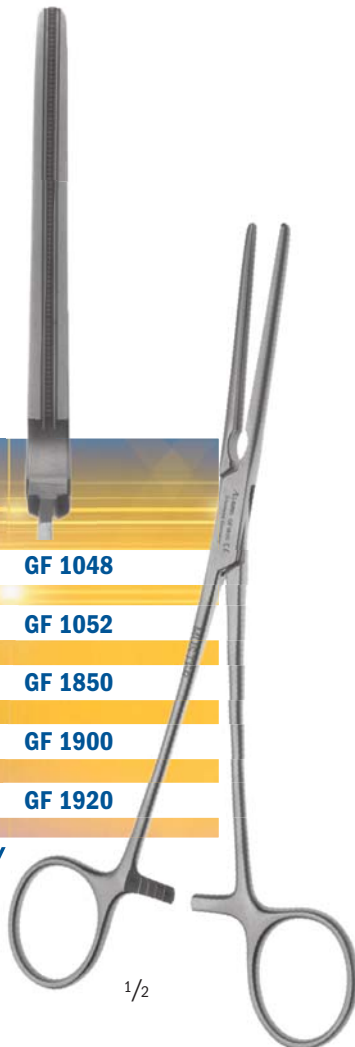

1/2



1/1

gebogen  
curved

165 mm, 6<sup>1</sup>/<sub>2</sub>"

**GF 1049**

185 mm, 7<sup>1</sup>/<sub>4</sub>"

**GF 1053**

205 mm, 8"

**GF 1860**

260 mm, 10<sup>1</sup>/<sub>4</sub>"

**GF 1911**

280 mm, 11"

**GF 1930**

**DE BAKEY  
PEAN**



1/2

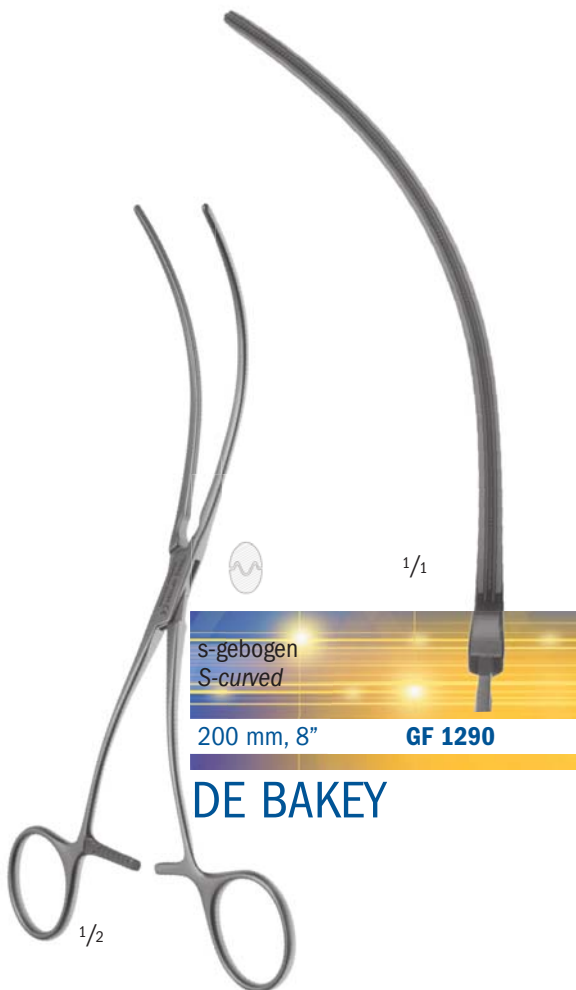
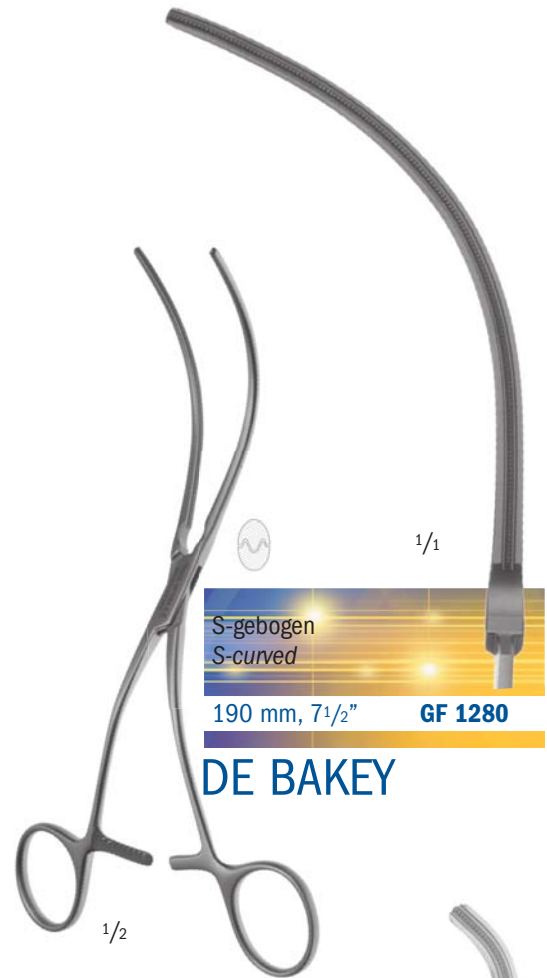



**DE BAKEY**



**LELAND-JONES  
DE BAKEY**

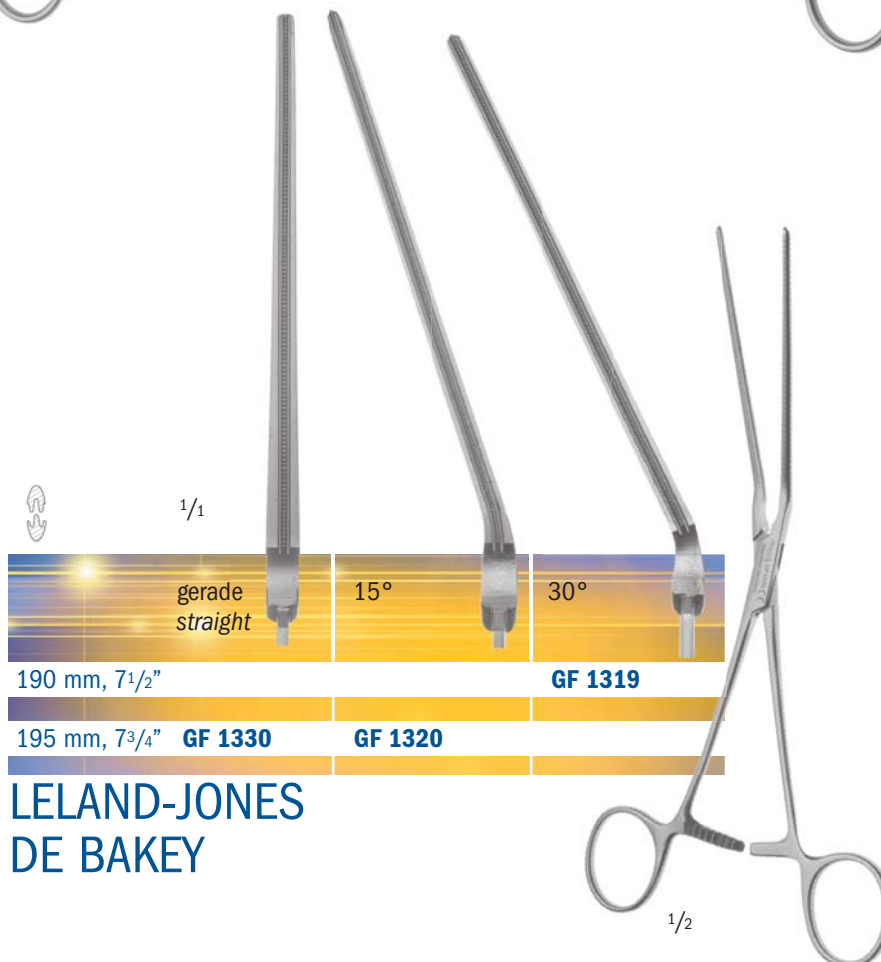
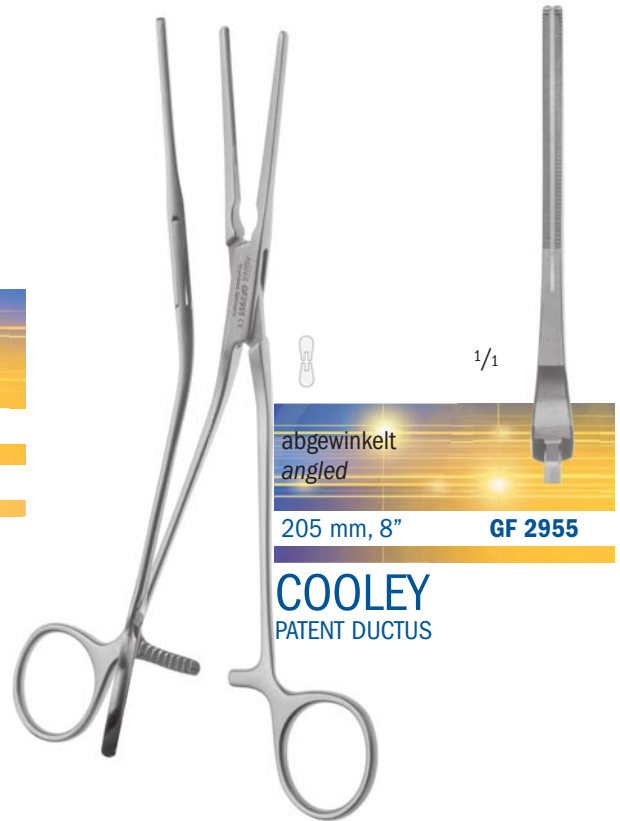
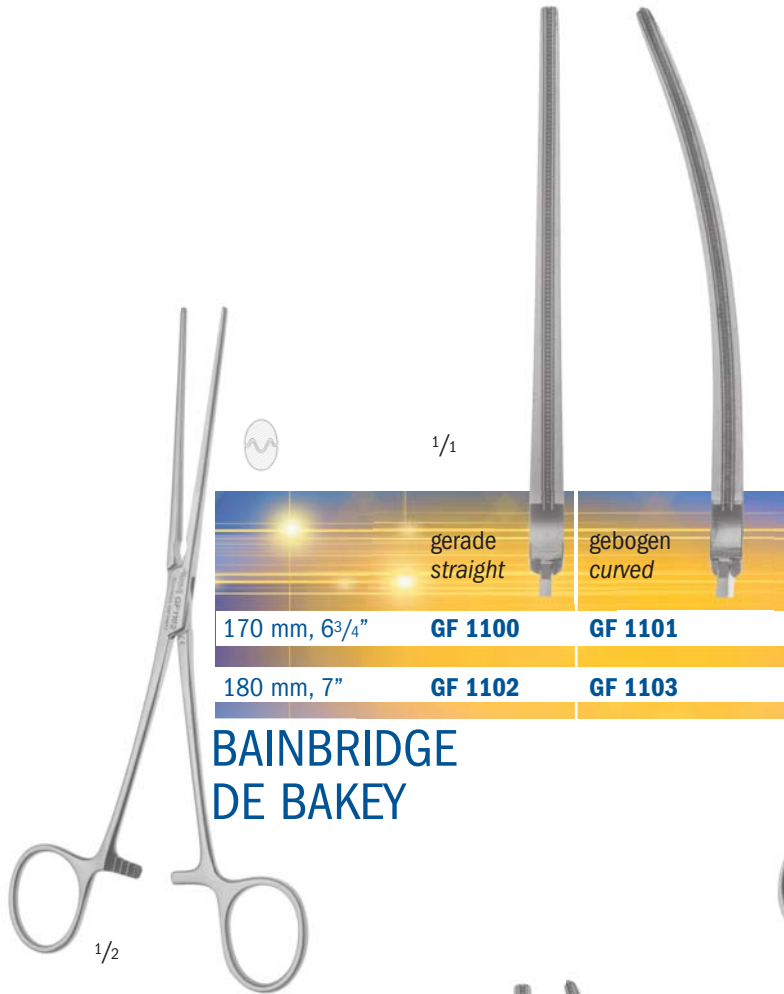

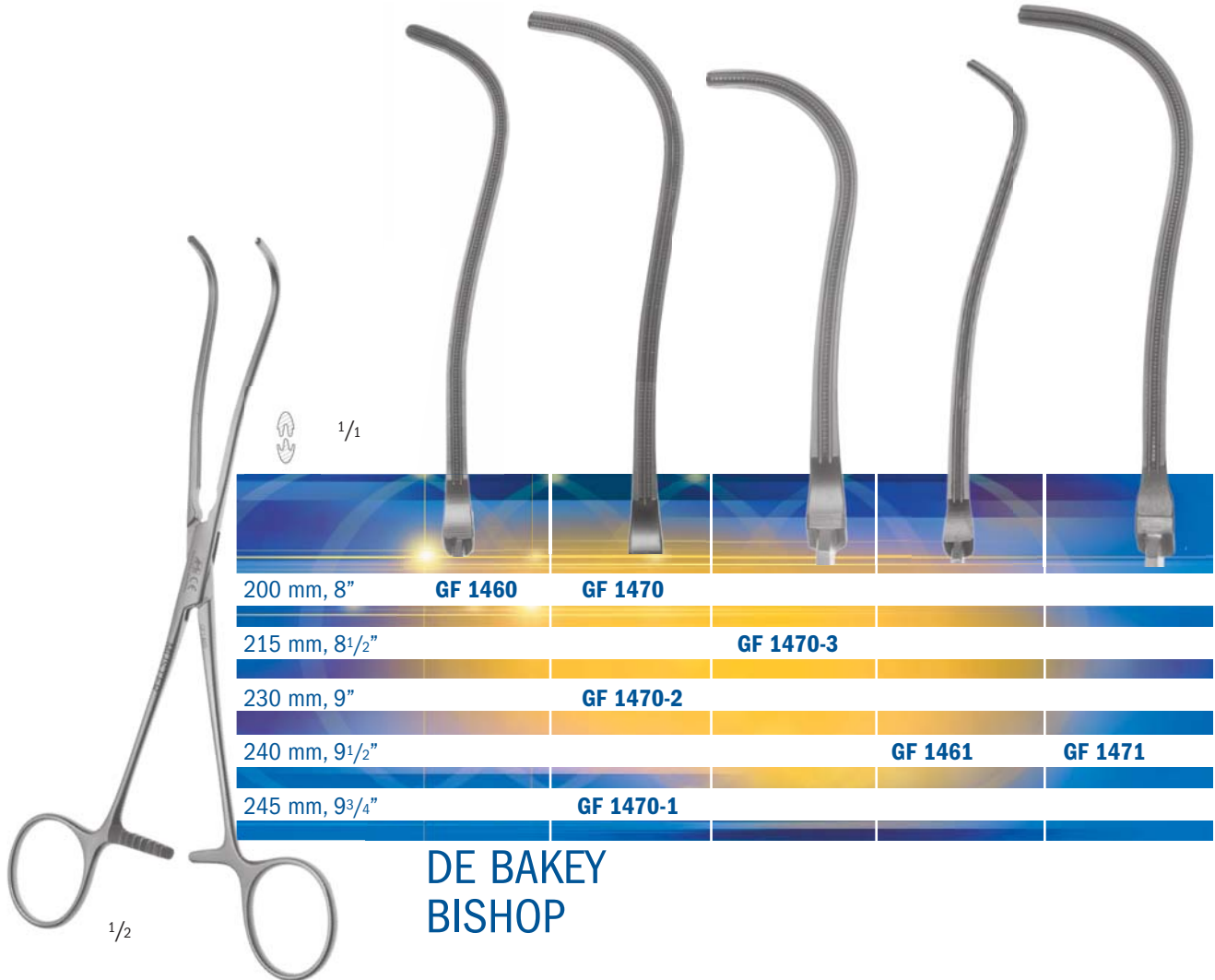





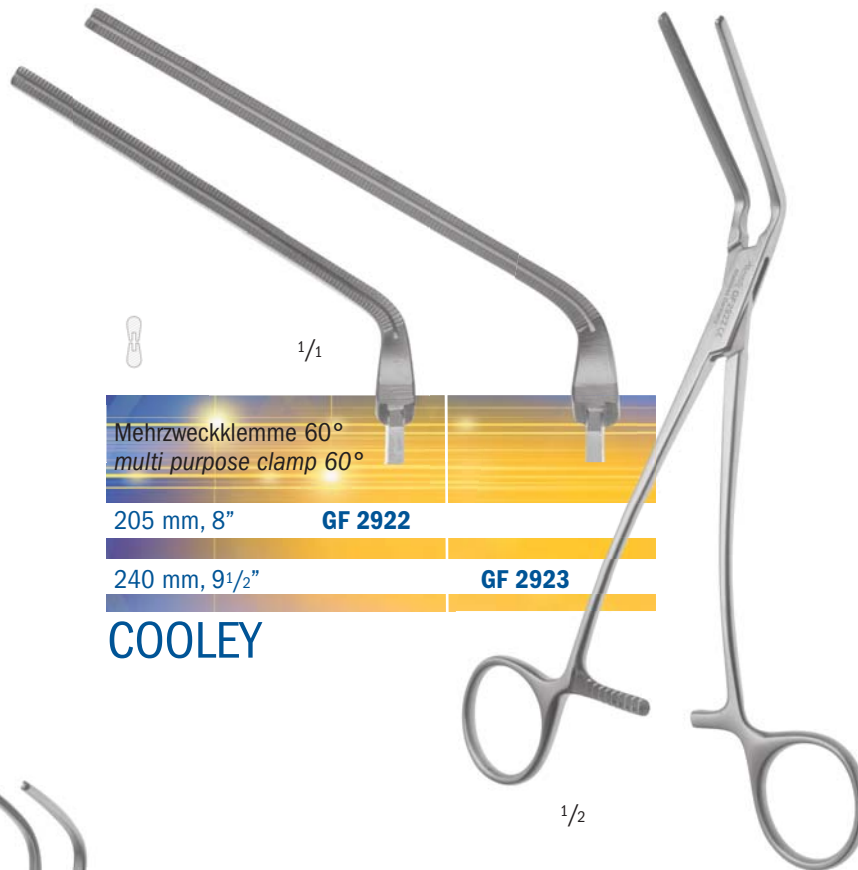

Mehrzweckklemme 60°  
multi purpose clamp 60°

205 mm, 8" **GF 2922**

240 mm, 9 1/2" **GF 2923**

**COOLEY**



Ligaturklemme  
ligature clamp

215 mm, 8 1/4" **GF 1589**

285 mm, 11 1/4" **GF 1590**

**DE BAKEY MIXTER**



Anastomosenklemme Anastomosis clamp	klein small	mittel medium	groß large
165 mm, 6 <sup>1</sup> / <sub>2</sub> "	<b>GF 2040</b>		
170 mm, 6 <sup>3</sup> / <sub>4</sub> "		<b>GF 2050</b>	
175 mm, 7"			<b>GF 2060</b>
205 mm, 8"	<b>GF 2041</b>		
210 mm, 8 <sup>1</sup> / <sub>4</sub> "		<b>GF 2051</b>	<b>GF 2061</b>
235 mm, 9 <sup>1</sup> / <sub>4</sub> "	<b>GF 2042</b>	<b>GF 2052</b>	<b>GF 2062</b>

**DE BAKY  
DERRA**



Anastomosenklemme  
Anastomosis clamp

170 mm, 6<sup>3</sup>/<sub>4</sub>" **GF 2070**

**DE BAKY**



1/1

Coarctationsklemme, gerade  
Coarctation clamp, straight

170 mm, 6<sup>3</sup>/<sub>4</sub>"

**GF 2610**

**COOLEY**

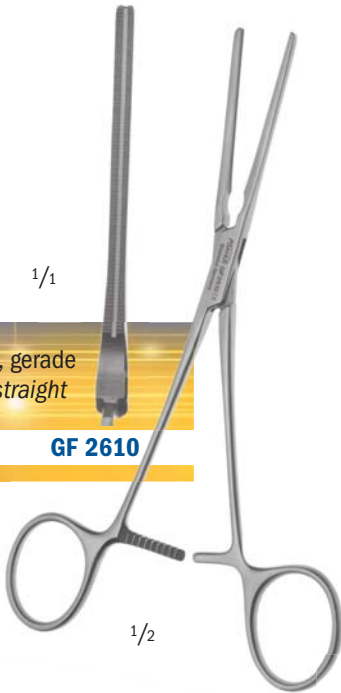

1/1

Coarctationsklemme, gebogen, graduiert  
Coarctation clamp, curved, graduated

170 mm, 6<sup>3</sup>/<sub>4</sub>"

**GF 2620**

**COOLEY**

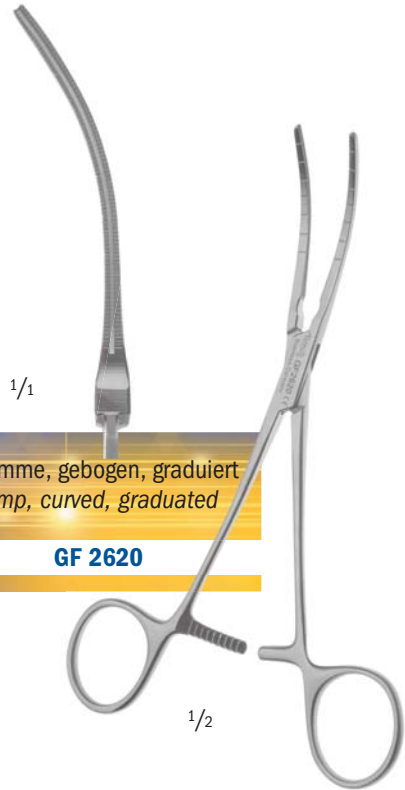

1/1

Coarctationsklemme, gebogen  
Coarctation clamp, curved

170 mm, 6<sup>3</sup>/<sub>4</sub>"

**GF 2630**

**COOLEY**



1/1

gebogen  
angled

graduiert  
graduated

165 mm, 6<sup>1</sup>/<sub>2</sub>"

**GF 2720**

175 mm, 7"

**GF 2730**

**GF 2740**

**COOLEY DERRA**



1/2



DE BAKEY 2x3

1/1

atraumatisch  
*atraumatic*

310 mm, 12<sup>3</sup>/<sub>8</sub>"

MD 0940

**KERSTING**

Abdominale Anastomosenklemme/  
*Abdominal Anastomosis Clamps*

1/2

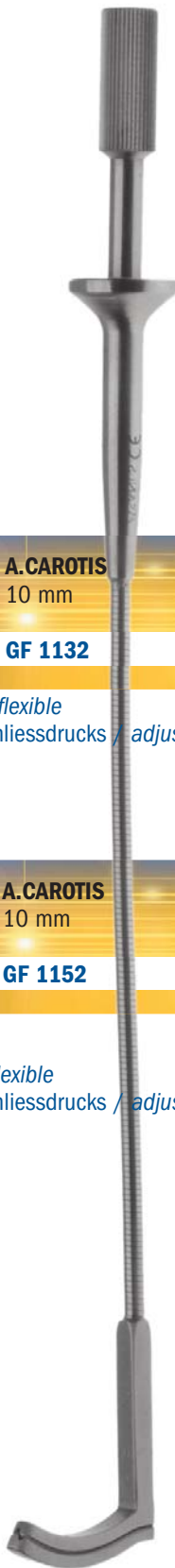

glatt smooth	<b>A.CAROTIS</b> 10 mm	<b>A.POPLITEA</b> 20 mm	<b>A.FEMORALIS</b> 30 mm
210 mm, 8 <sup>1</sup> / <sub>4</sub> "	<b>GF 1132</b>	<b>GF 1134</b>	<b>GF 1136</b>

halbflexibel / semi flexible  
Regulierung der Schliessdrucks / adjustment of closing pressure

atraumatisch atraumatic	<b>A.CAROTIS</b> 10 mm	<b>A.POPLITEA</b> 20 mm	<b>A.FEMORALIS</b> 30 mm
220 mm, 8 <sup>3</sup> / <sub>4</sub> "	<b>GF 1152</b>	<b>GF 1154</b>	<b>GF 1156</b>

## COOLEY

völlig flexibel / all flexible  
Regulierung der Schliessdrucks / adjustment of closing pressure

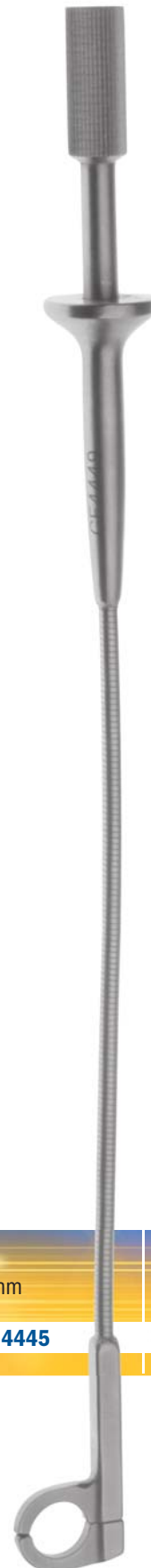

	3 mm	5 mm	7 mm	9 mm
220 mm, 8 <sup>3</sup> / <sub>4</sub> "	<b>GF 4443</b>	<b>GF 4445</b>	<b>GF 4447</b>	<b>GF 4449</b>

## SHUNT

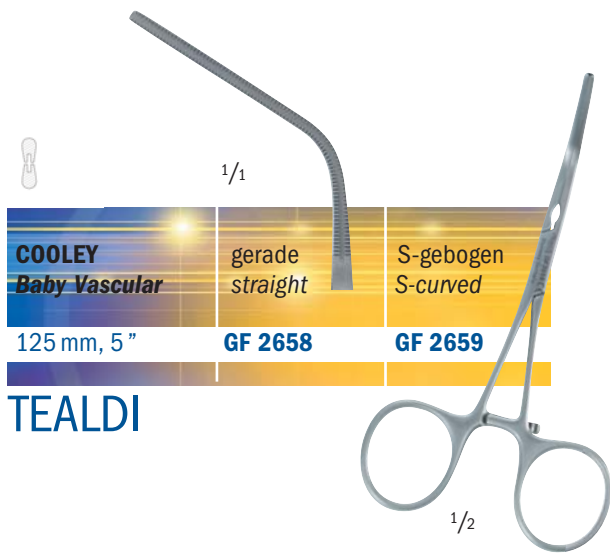

TEALDI

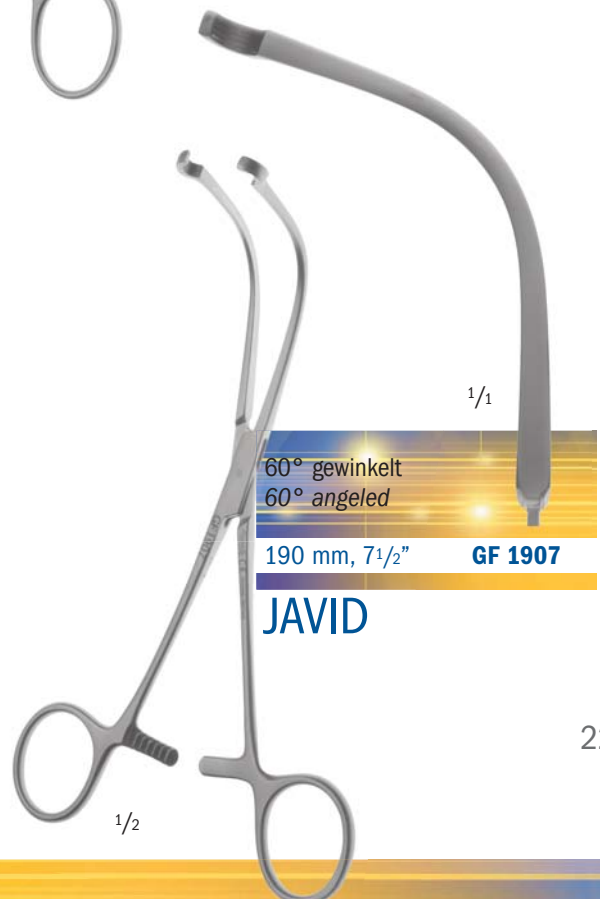
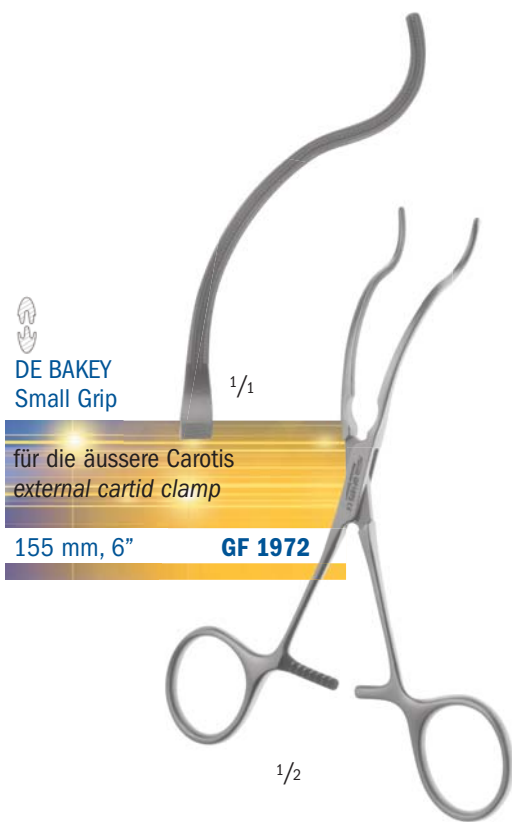
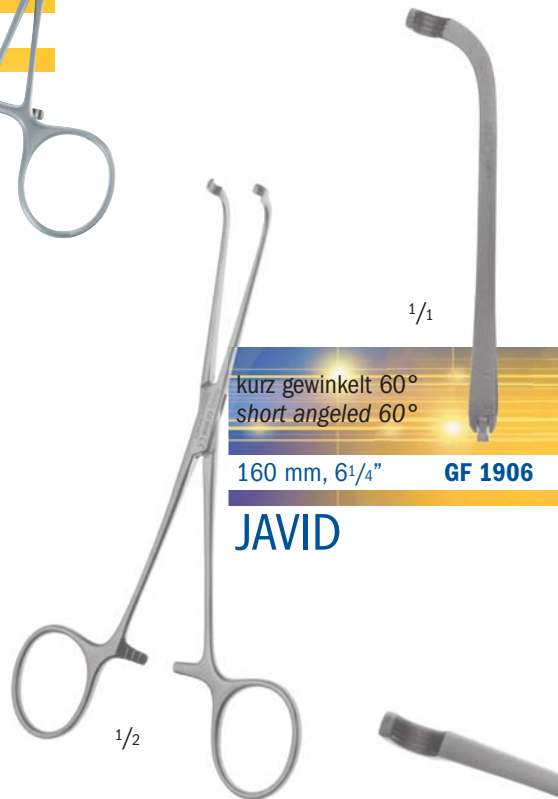

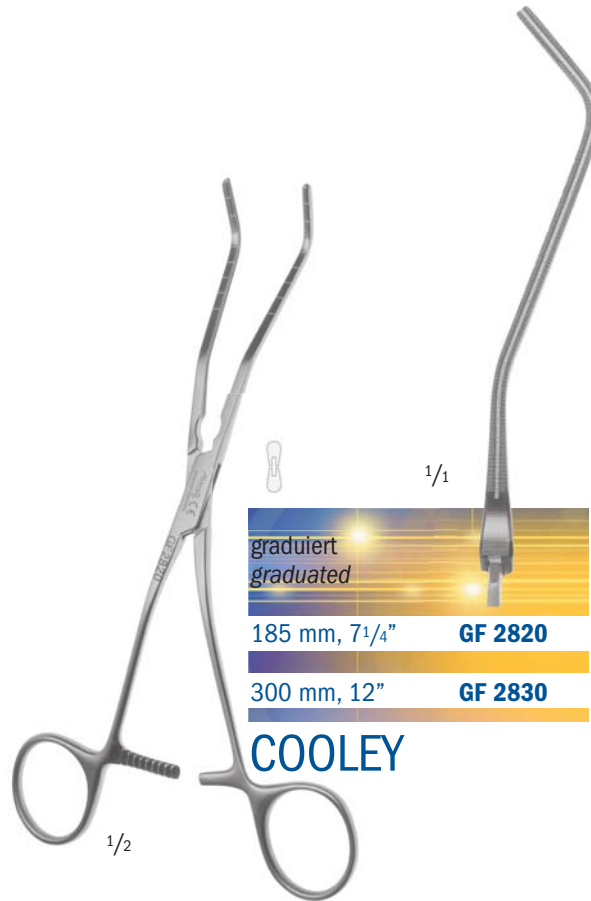





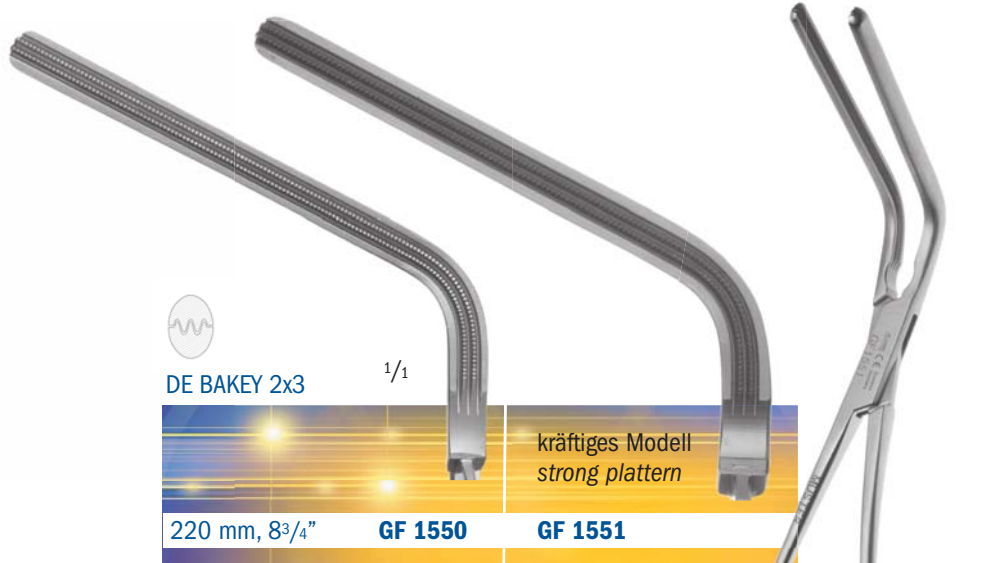

**MORRIS**

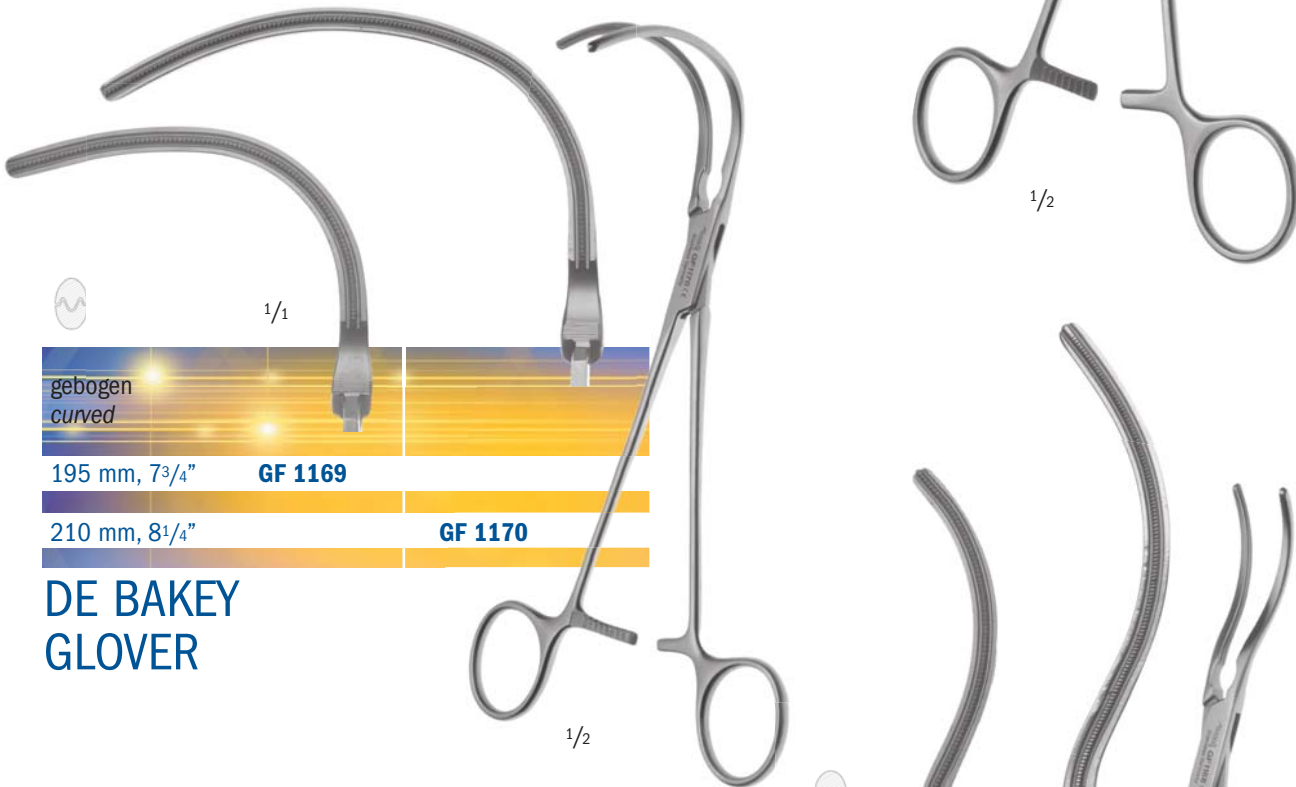

**DE BAKEY  
GLOVER**



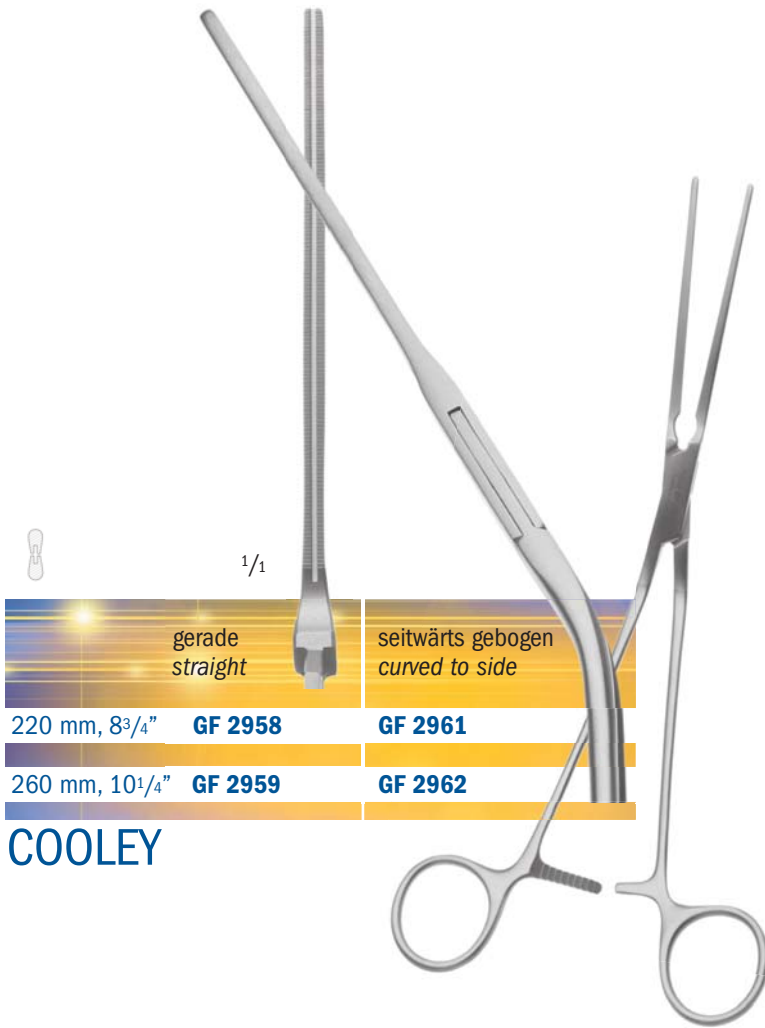

**DE BAKEY  
GLOVER  
SPOON SHARPED**

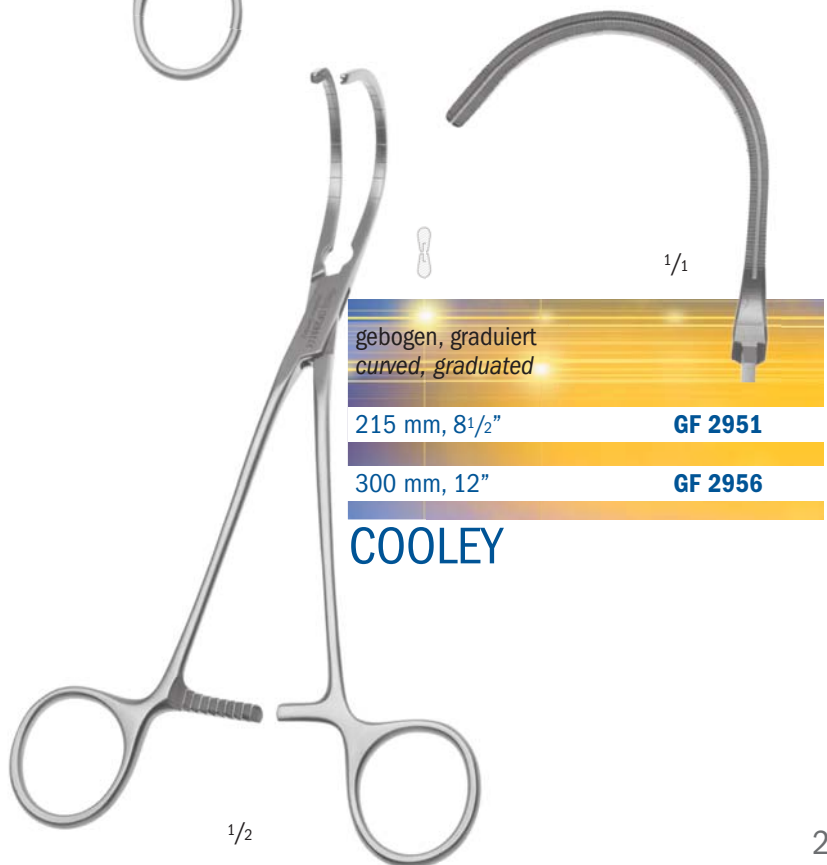

	1/1	gerade straight	seitwärts gebogen curved to side
220 mm, 8 <sup>3</sup> / <sub>4</sub> "	<b>GF 2958</b>	<b>GF 2961</b>	
260 mm, 10 <sup>1</sup> / <sub>4</sub> "	<b>GF 2959</b>	<b>GF 2962</b>	

**COOLEY**



	1/1	gebogen, graduiert curved, graduated
215 mm, 8 <sup>1</sup> / <sub>2</sub> "	<b>GF 2951</b>	
300 mm, 12"	<b>GF 2956</b>	

**COOLEY**

1/2

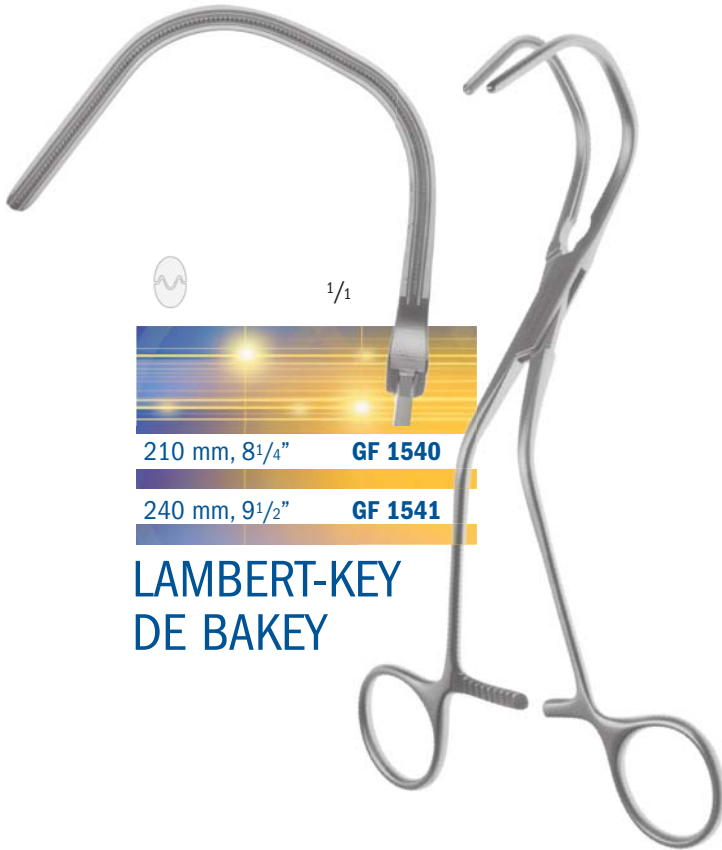

210 mm, 8 <sup>1</sup> / <sub>4</sub> "	<b>GF 1540</b>
240 mm, 9 <sup>1</sup> / <sub>2</sub> "	<b>GF 1541</b>

**LAMBERT-KEY  
DE BAKEY**



215 mm, 8 <sup>1</sup> / <sub>2</sub> "	<b>GF 1520</b>
---	----------------

**LAMBERT-KEY  
DE BAKEY**

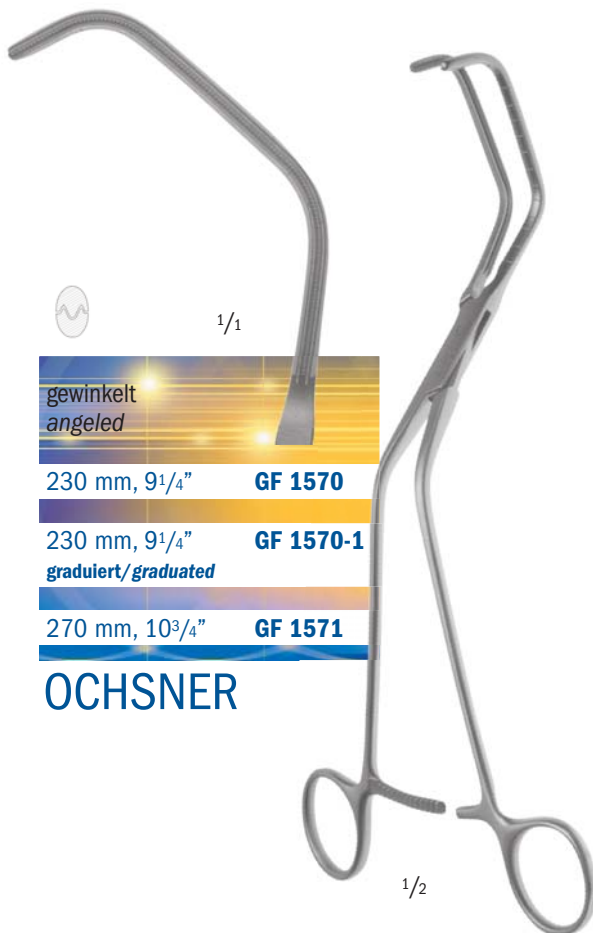

gewinkelt angeled	
230 mm, 9 <sup>1</sup> / <sub>4</sub> "	<b>GF 1570</b>
230 mm, 9 <sup>1</sup> / <sub>4</sub> " graduirt/graduated	<b>GF 1570-1</b>
270 mm, 10 <sup>3</sup> / <sub>4</sub> "	<b>GF 1571</b>

**OCHSNER**

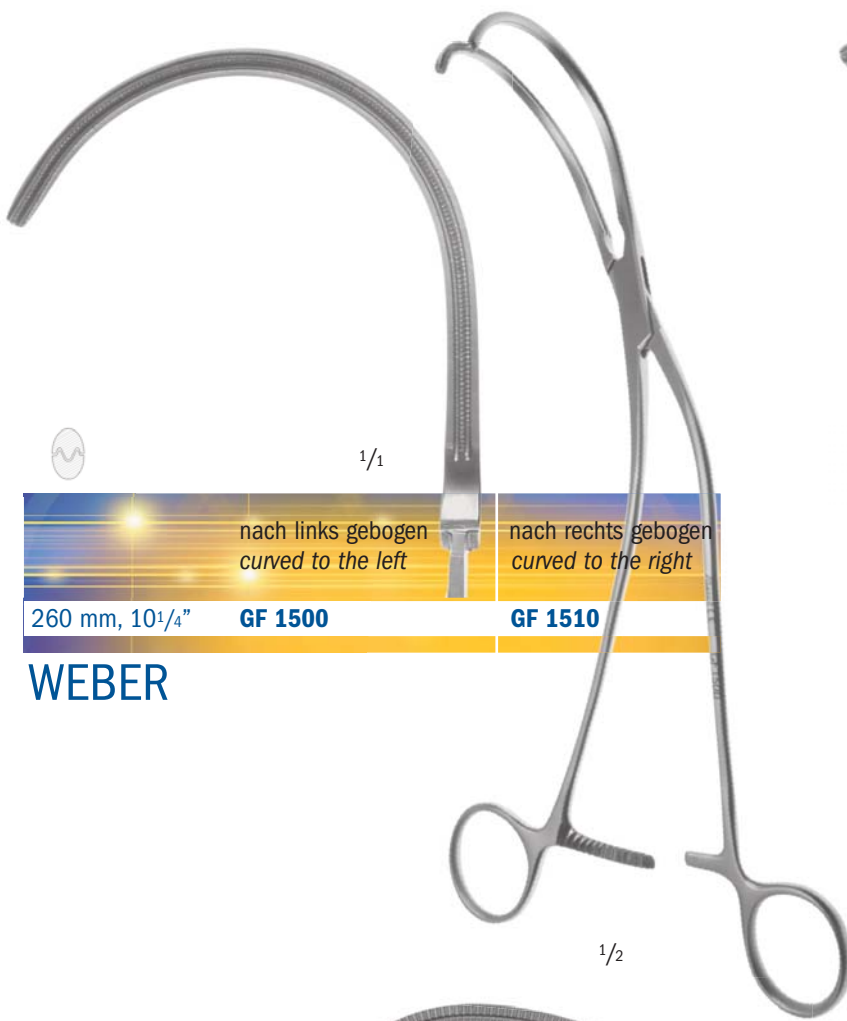

1/1  
nach links gebogen  
curved to the left  
260 mm, 10<sup>1</sup>/<sub>4</sub>" **GF 1500**

1/1  
nach rechts gebogen  
curved to the right  
260 mm, 10<sup>1</sup>/<sub>4</sub>" **GF 1510**

**WEBER**



1/1  
abgewinkelt  
angled  
210 mm, 8<sup>1</sup>/<sub>4</sub>" **GF 1840**

**DIETRICH**

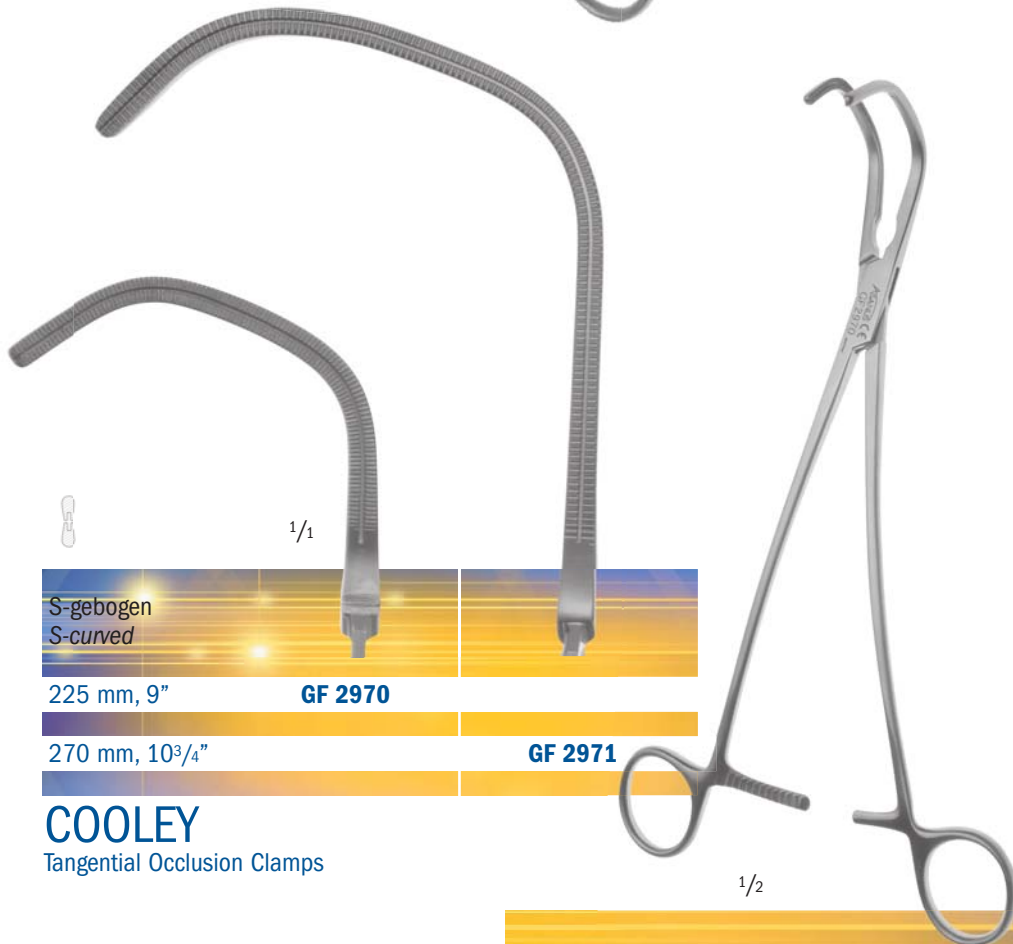

1/1  
S-gebogen  
S-curved  
225 mm, 9" **GF 2970**

1/1  
270 mm, 10<sup>3</sup>/<sub>4</sub>" **GF 2971**

**COOLEY**  
Tangential Occlusion Clamps



S-gebogen  
S-curved  
260 mm, 10<sup>1</sup>/<sub>4</sub>" **GF 2972**

**COOLEY**

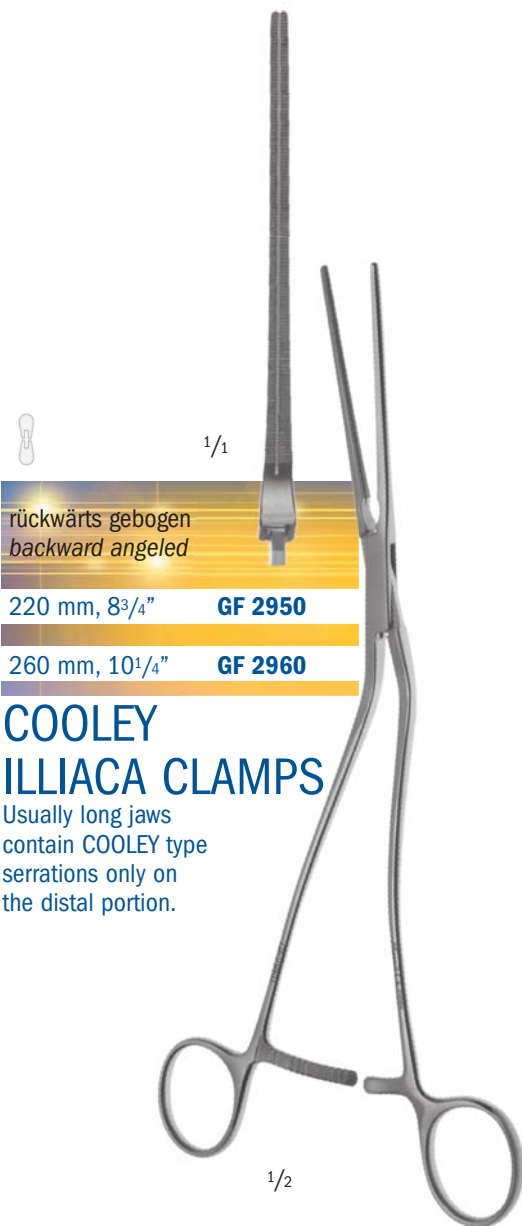

rückwärts gebogen  
backward angled  
220 mm, 8<sup>3</sup>/<sub>4</sub>" **GF 2950**  
260 mm, 10<sup>1</sup>/<sub>4</sub>" **GF 2960**

**COOLEY  
ILLIACA CLAMPS**

Usually long jaws contain COOLEY type serrations only on the distal portion.

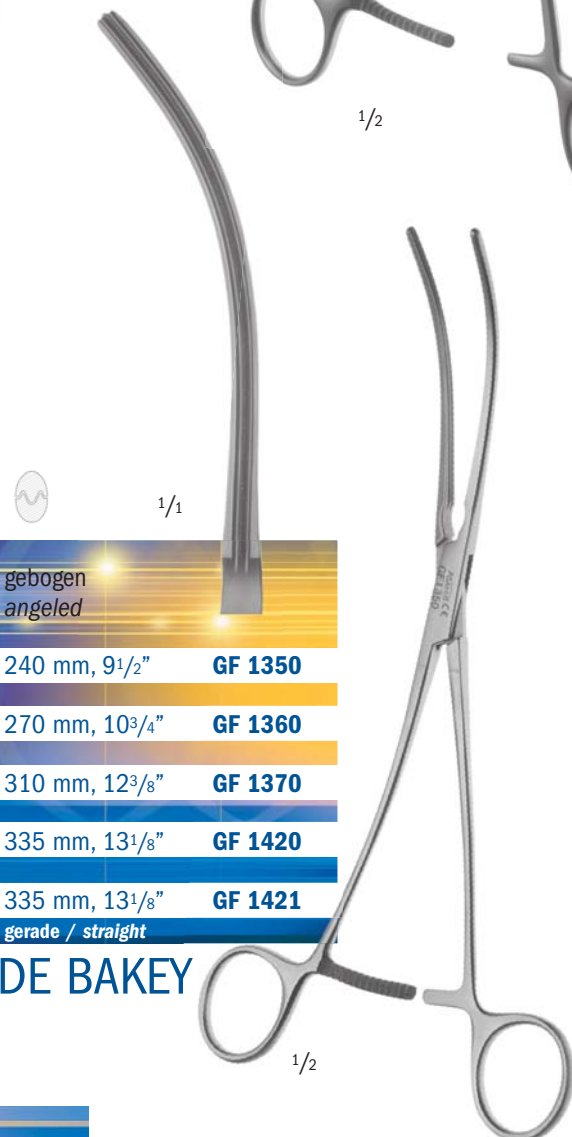

gebogen  
angled  
240 mm, 9<sup>1</sup>/<sub>2</sub>" **GF 1350**  
270 mm, 10<sup>3</sup>/<sub>4</sub>" **GF 1360**  
310 mm, 12<sup>3</sup>/<sub>8</sub>" **GF 1370**  
335 mm, 13<sup>1</sup>/<sub>8</sub>" **GF 1420**  
335 mm, 13<sup>1</sup>/<sub>8</sub>" **GF 1421**  
gerade / straight

**DE BAKEY**



 1/1  
245 mm, 9<sup>3</sup>/<sub>4</sub>" **GF 1390**  
255 mm, 10" **GF 1400**

DE BAKY  
BAHNSON



 1/1  
265 mm, 10<sup>1</sup>/<sub>4</sub>" **GF 1430**

DE BAKY



 1/1  
245 mm, 9<sup>3</sup>/<sub>4</sub>" **GF 2933**  
335 mm, 13<sup>1</sup>/<sub>8</sub>" **GF 2935**

COOLEY

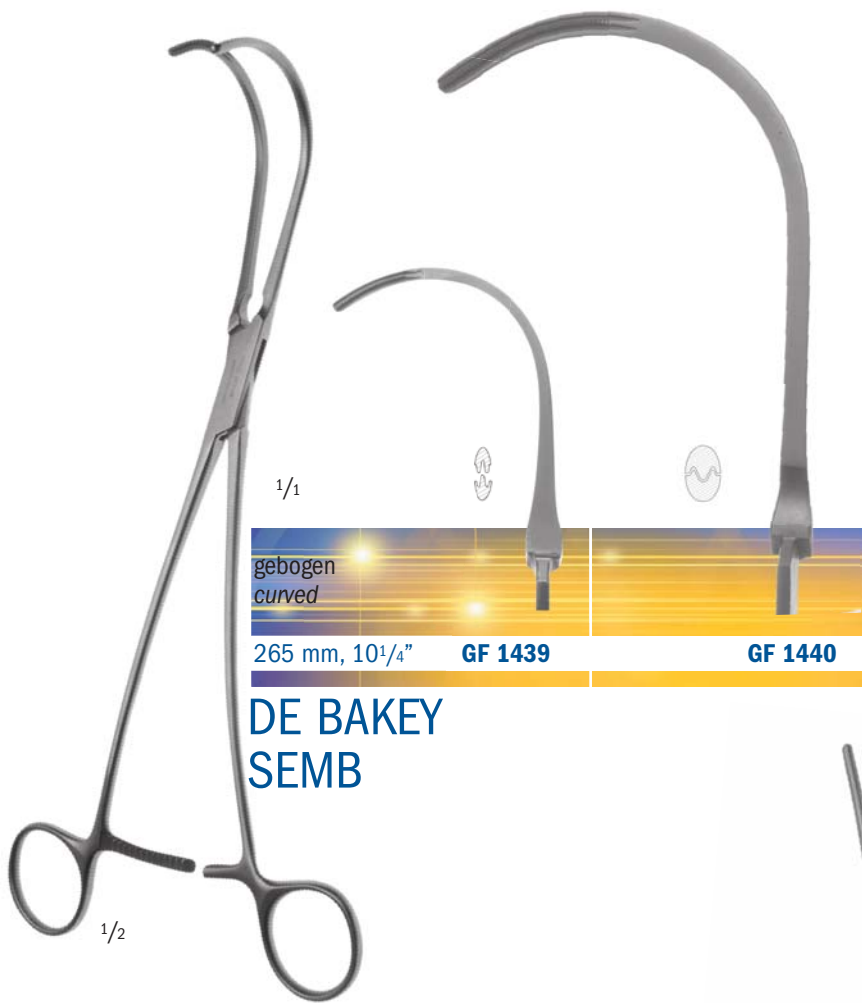

**DE BAKEY  
SEMB**

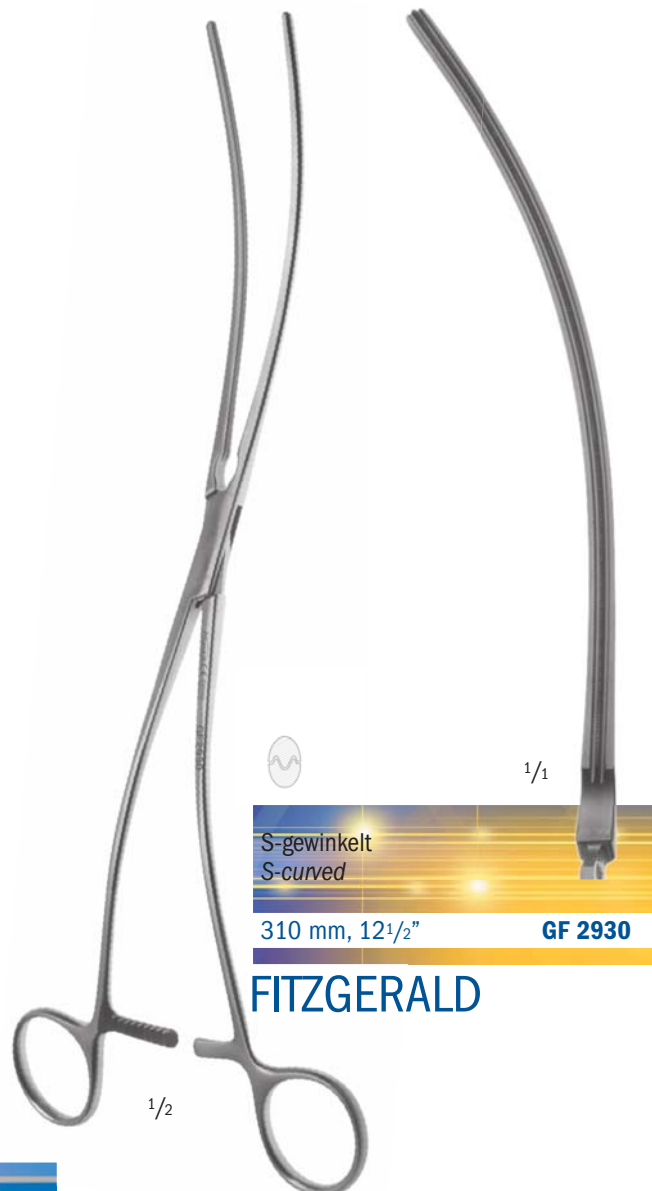

**FITZGERALD**





VIGANO

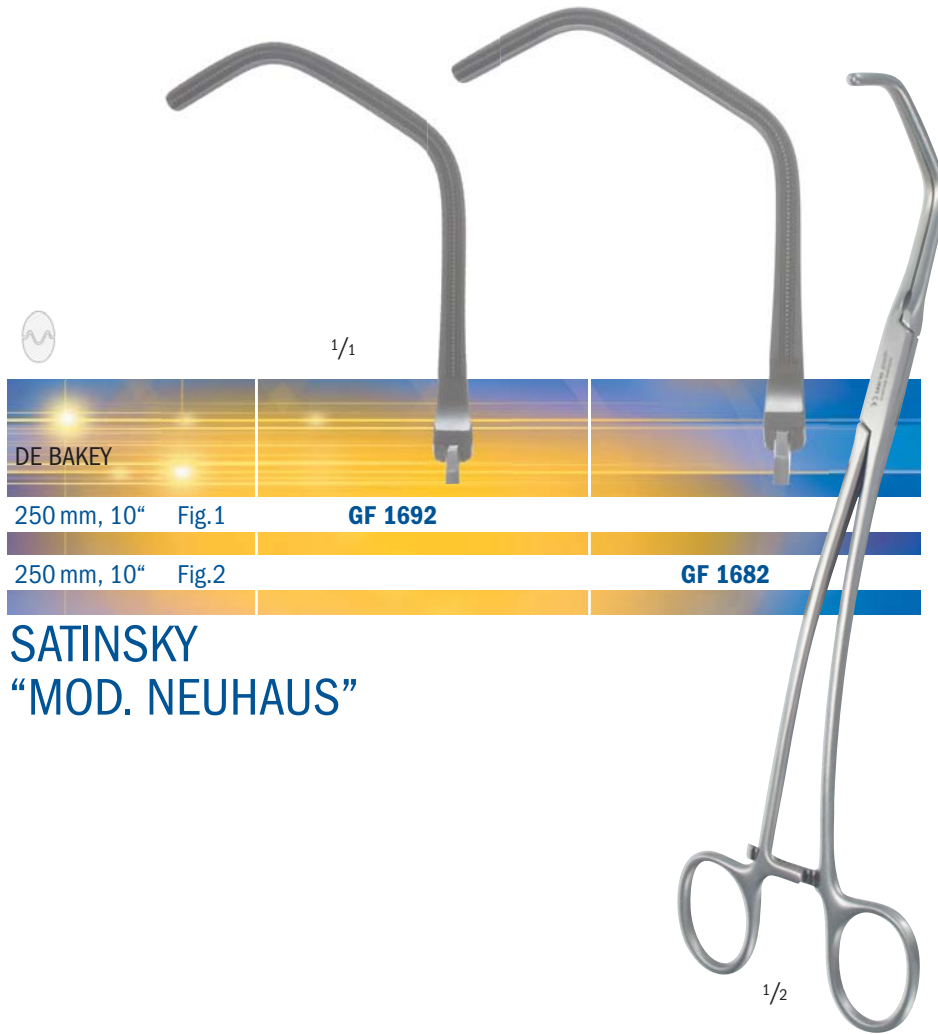

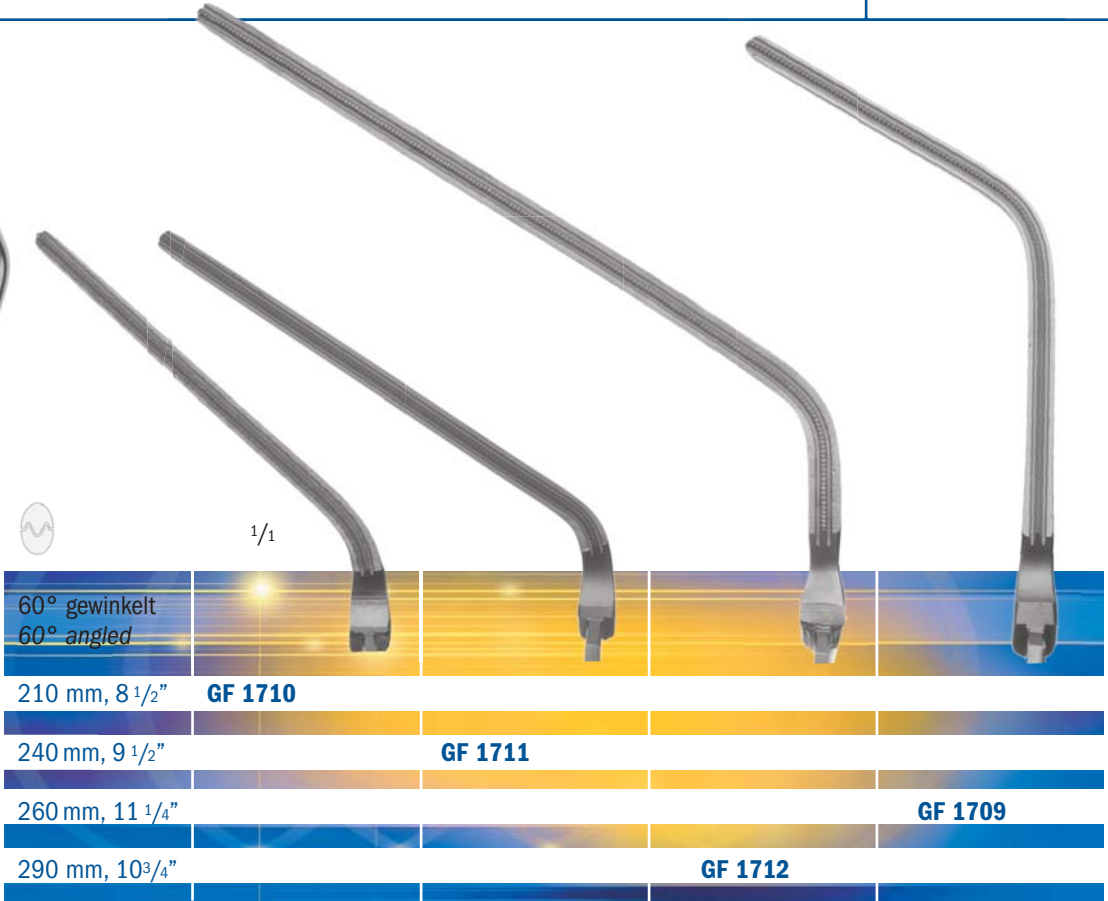
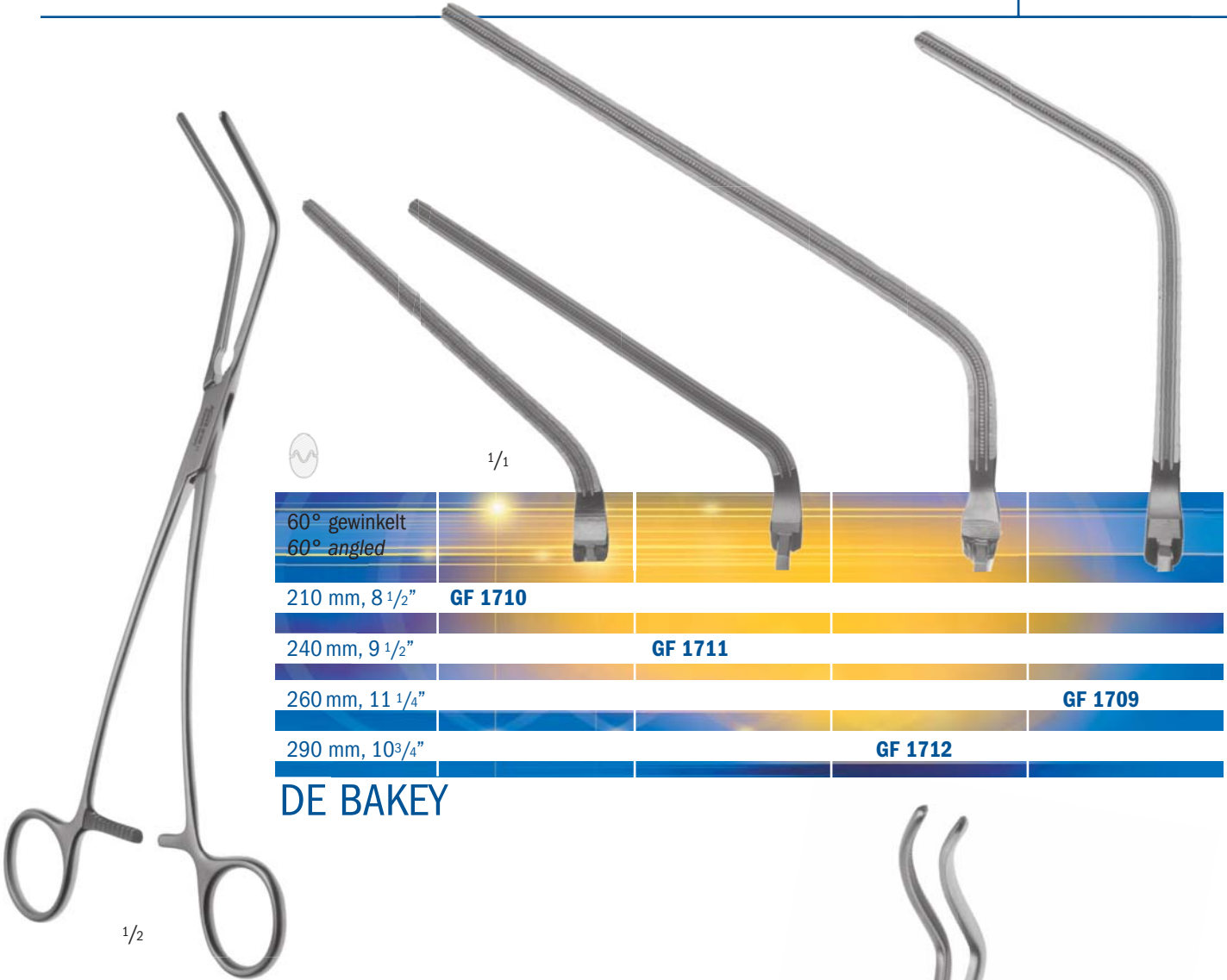

**DE BAKEY**



**DE BAKEY**



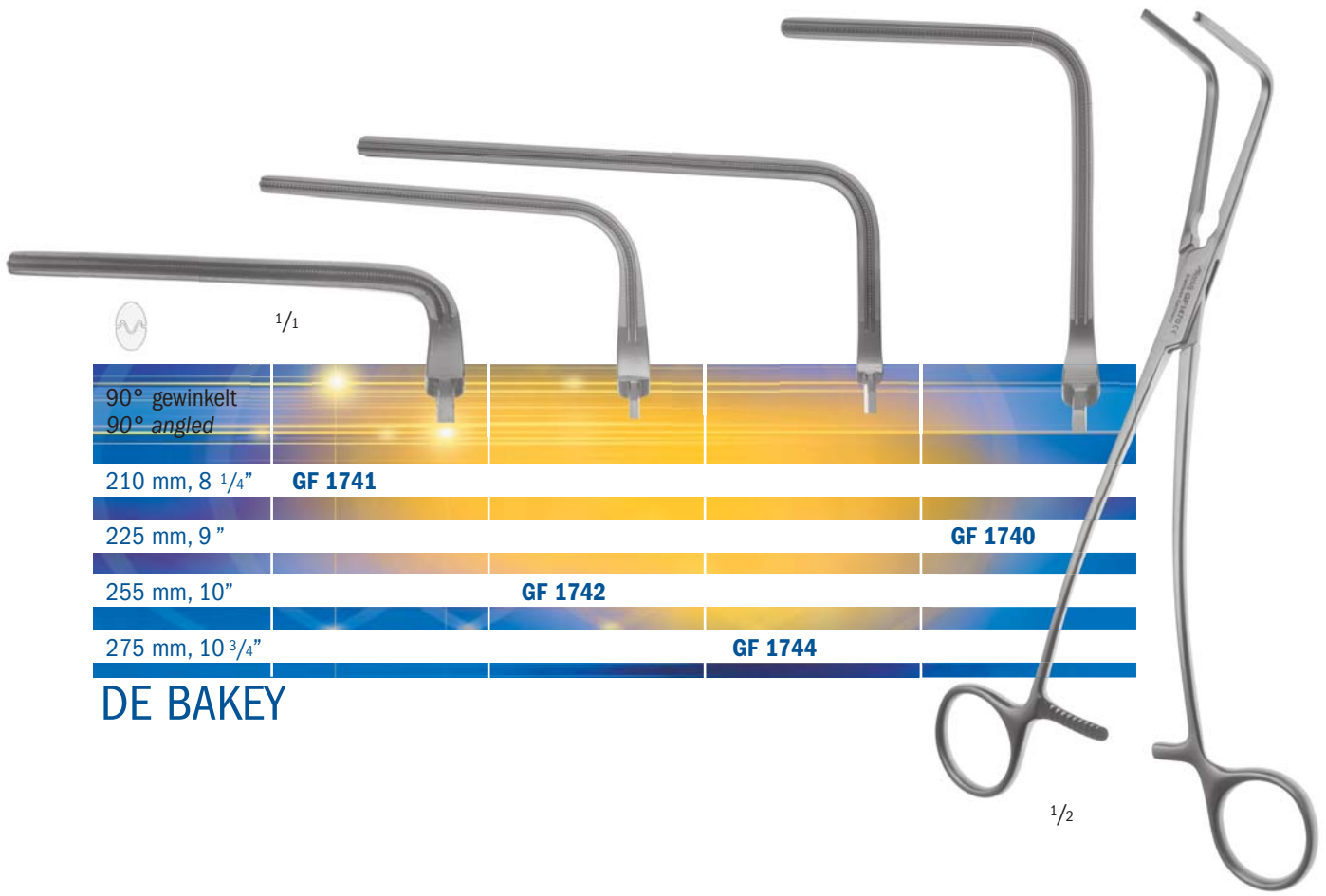

**DE BAKAY**

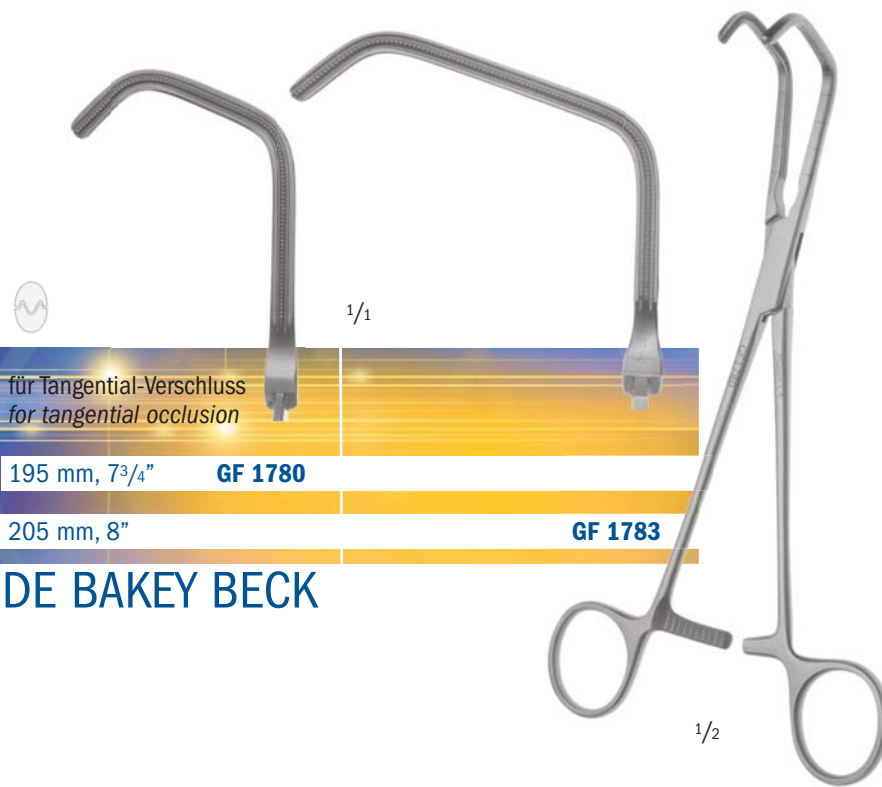

**DE BAKAY BECK**

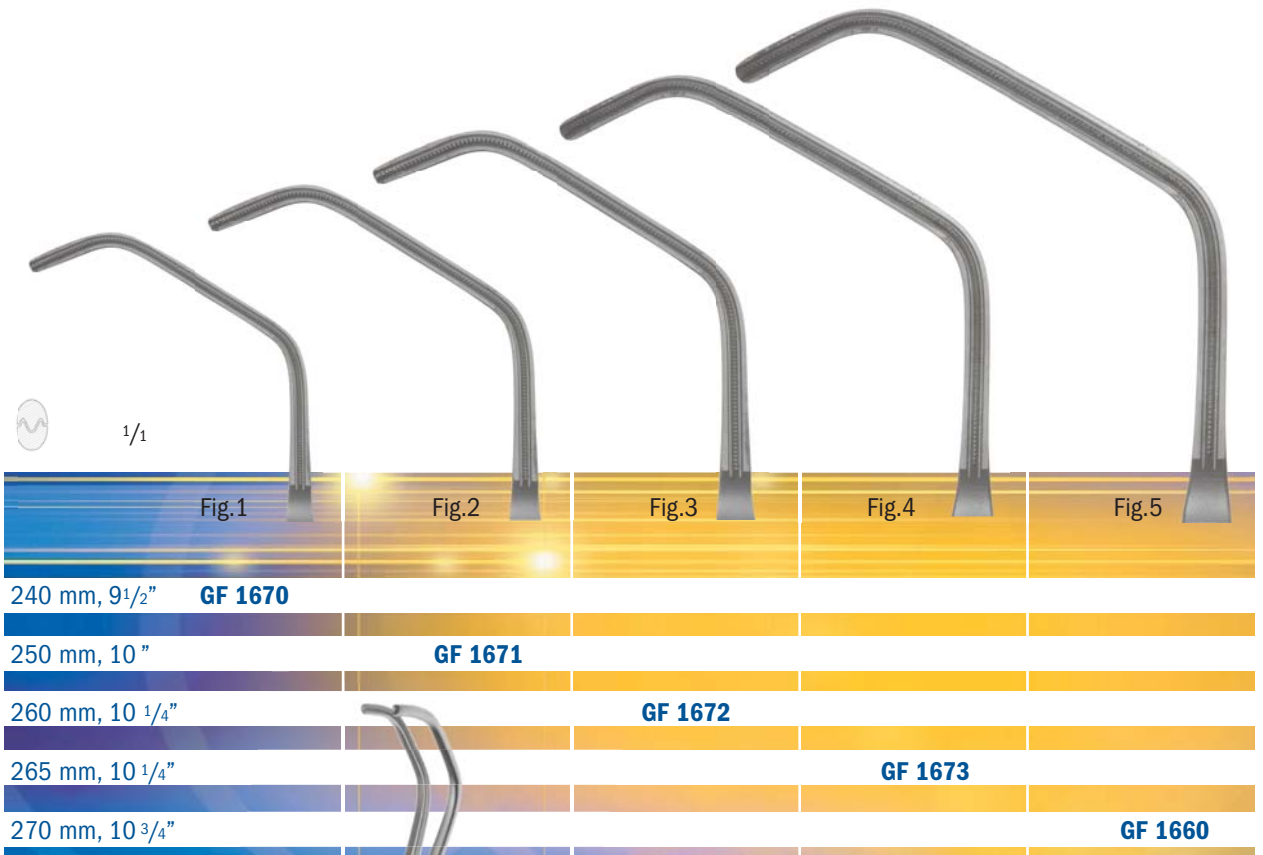

DE BAKEY  
SATINSKY



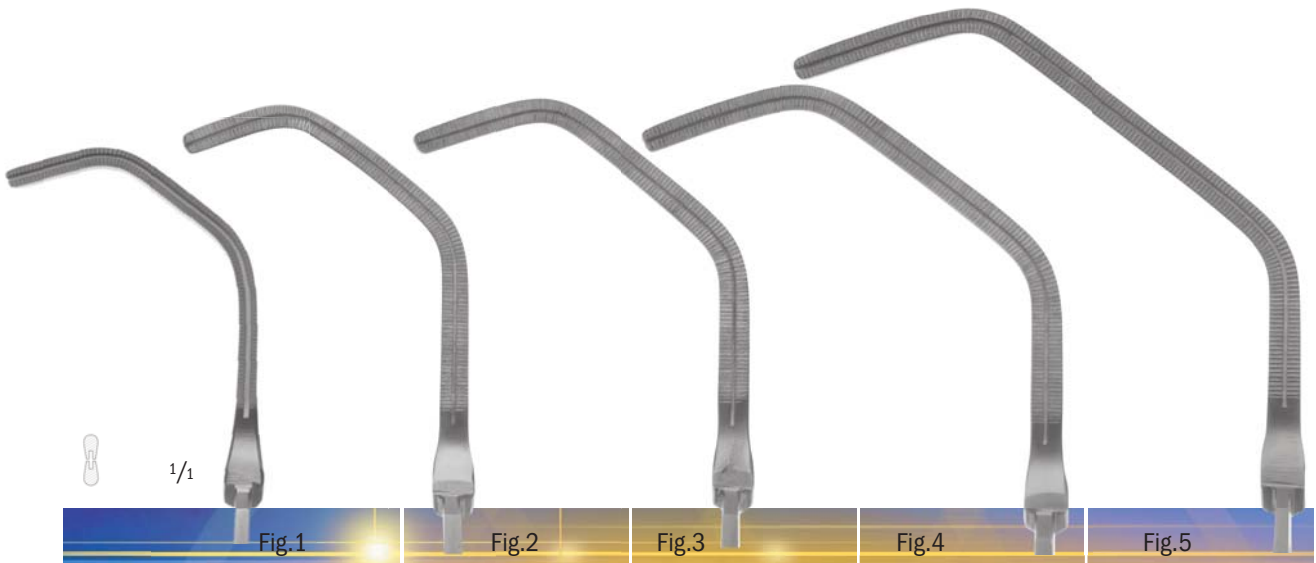

Fig.1	Fig.2	Fig.3	Fig.4	Fig.5
195 mm, 7 3/4"	<b>GF 3000</b>			
250 mm, 10"		<b>GF 3010</b>		
255 mm, 10"			<b>GF 3020</b>	
265 mm, 10 1/4"				<b>GF 3030</b>
270 mm, 10 3/4"				<b>GF 3040</b>

**COOLEY  
SATINSKY**





Vena Cava Klemme  
Vena Cava clamp

240 mm, 9 1/2" **GF 2320**

HARKEN



für den Herzvorhof  
gebogen  
Auricle Clamps  
curved

250 mm, 10" **GF 1800**

DE BAKEY  
HARKEN

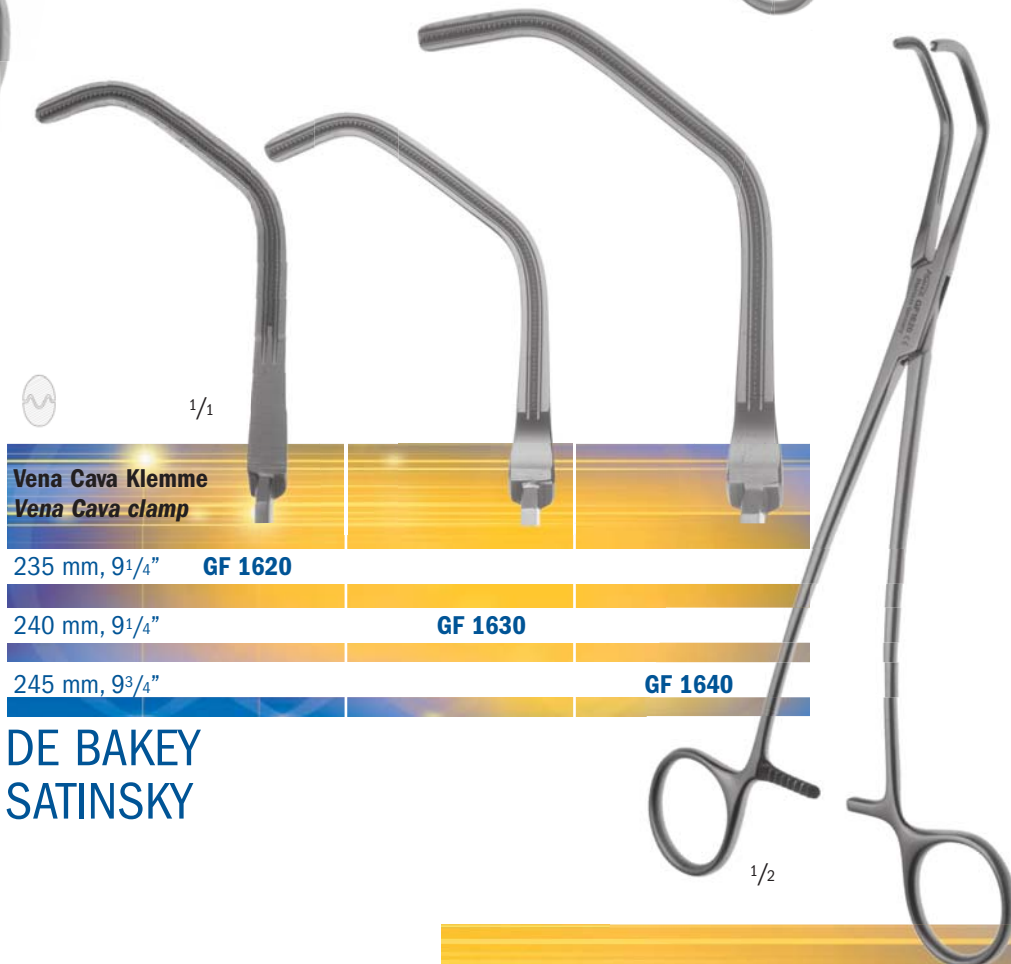

Vena Cava Klemme  
Vena Cava clamp

235 mm, 9 1/4" **GF 1620**

240 mm, 9 1/4" **GF 1630**

245 mm, 9 3/4" **GF 1640**

DE BAKEY  
SATINSKY



<b>60° gewinkelt</b> <b>60° angled</b>		Mauleinsatz Jaw insert
145 mm, 5 <sup>3</sup> / <sub>4</sub> "	<b>GF 2400</b>	<b>33 mm</b>
250 mm, 10"	<b>GF 2480</b>	<b>61 mm</b>
255 mm, 10"	<b>GF 2481</b>	<b>87 mm</b>

<b>gerade</b> <b>straight</b>		Mauleinsatz Jaw insert
170 mm, 6 <sup>3</sup> / <sub>4</sub> "	<b>GF 2440</b>	<b>33 mm</b>
300 mm, 12"	<b>GF 2442</b>	<b>61 mm</b>
300 mm, 12"	<b>GF 2482</b>	<b>86 mm</b>

**FOGART ATRAUMATIC**  
**"MULTI CHANGE"**





Cooley, 90° gebogen  
Cooley, 90° curved

230 mm, 9"

GF 1382

MERLO

gebogen  
curved

90 mm, 3 1/2"

**KL 0670**

**JONES**



1/2

gebogen  
curved

95 mm, 3 3/4"

**KL 0740**

105 mm, 4 1/2"

**KL 0780**

110 mm, 4 3/8"

**KL 0750**

135 mm, 5 1/4"

**KL 0760**

155 mm, 6"

**KL 0762**

**BACKHAUS**



1/2

mit Schlauchhalterung  
with suction hose fixation

110 mm, 4 3/8"

**KL 0810**

**BACKHAUS-CLIP**

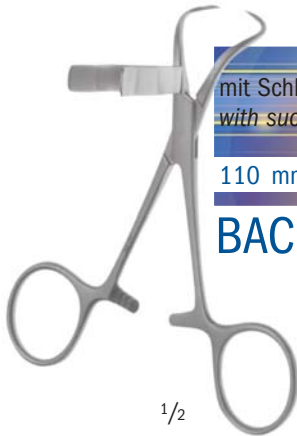

1/2

mit Kugel und Höhle  
with ball and socket

100 mm, 4"

**KL 0908**

115 mm, 4 1/8"

**KL 0920**

140 mm, 5 1/2"

**KL 0910**

150 mm, 6"

**KL 0911**

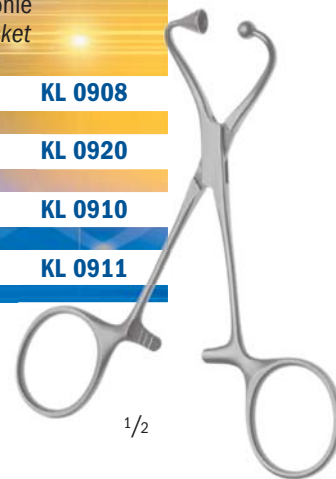

1/2

atraumatisch  
atraumatic

115 mm, 4 1/8"

**KL 0878**

130 mm, 5"

**KL 0879**

145 mm, 5 3/4"

**KL 0880**

**PEERS**



1/2

2 x 2 Zähne  
2 x 2 teeth

180 mm, 7"

**KL 0720**

**DOYEN**



1/2

Sortierklemme  
Instrument Organizer

140 mm, 5 1/2"

**KL 0091**

**MAYO**

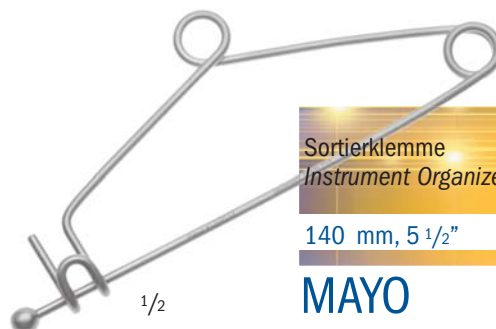

1/2



gerade, elastisch  
straight, elastic

130 mm, 5 1/8" **GF 2514**

**KRÖNLEIN**

1/2

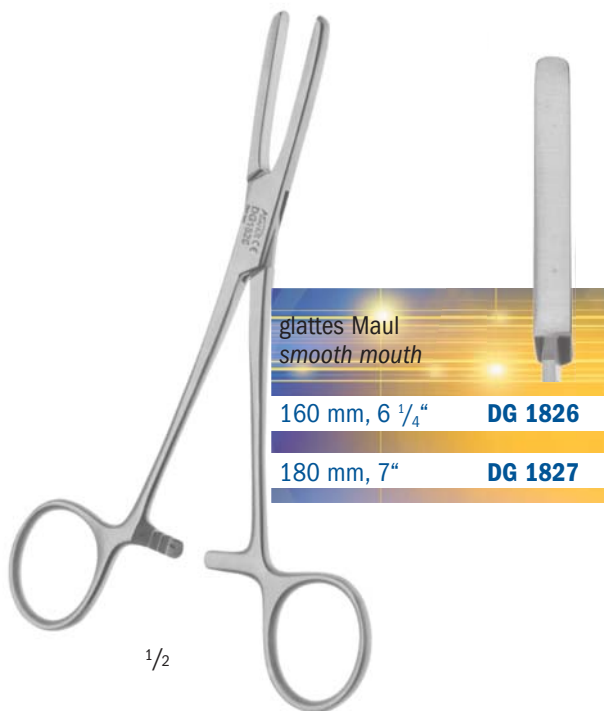

glattes Maul  
smooth mouth

160 mm, 6 1/4" **DG 1826**

180 mm, 7" **DG 1827**

1/2



mit Teflon-Rollen  
with tube miking roller

155 mm, 6" **GF 2525**

**BROMTON**

1/2

mit Stahl-Rollen  
with tube miking roller

185 mm, 7 1/4" **GF 2526**

**GUNNAR-HEY**



1/2

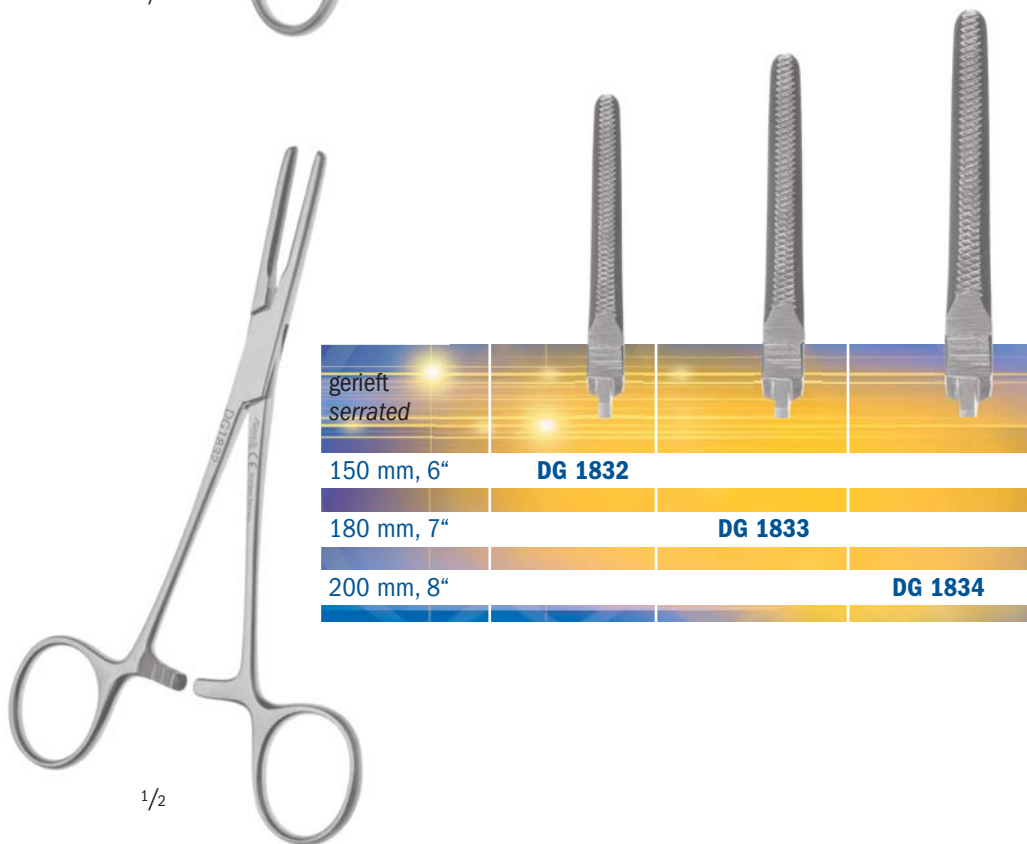
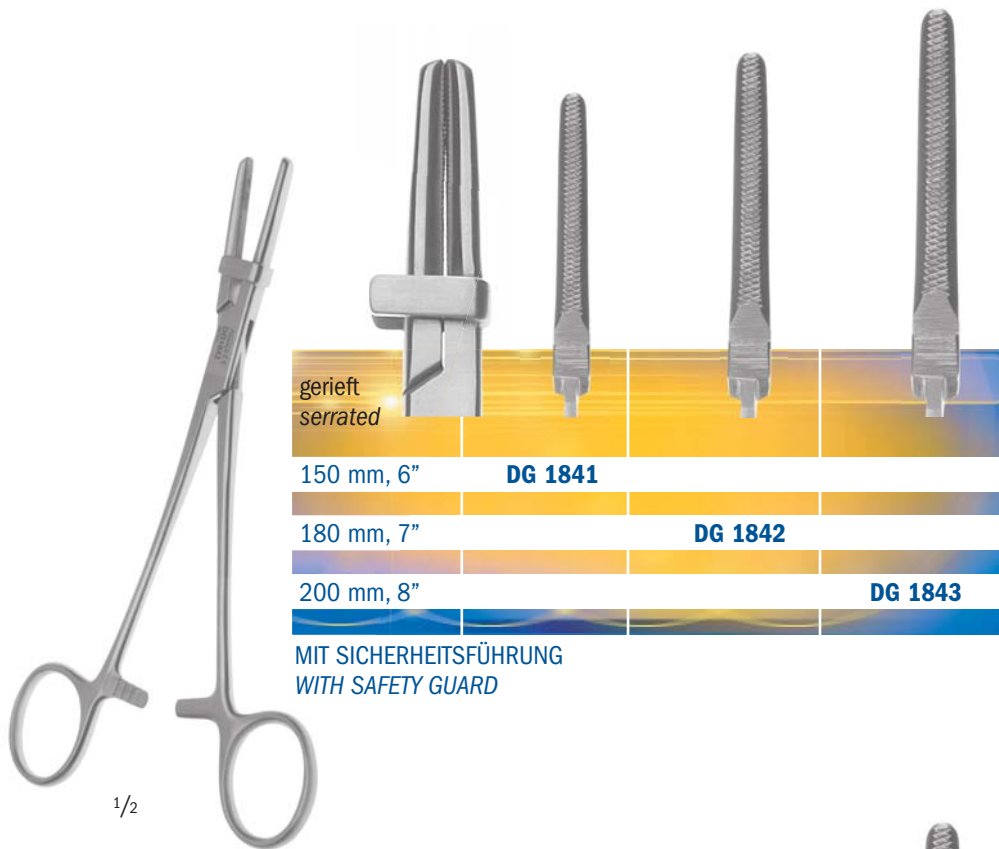

Spezial Stahlinstrumente Resterilisierbar  
Special Steel Instruments Sterilisable

Fadenhalterung  
Suture Fixation

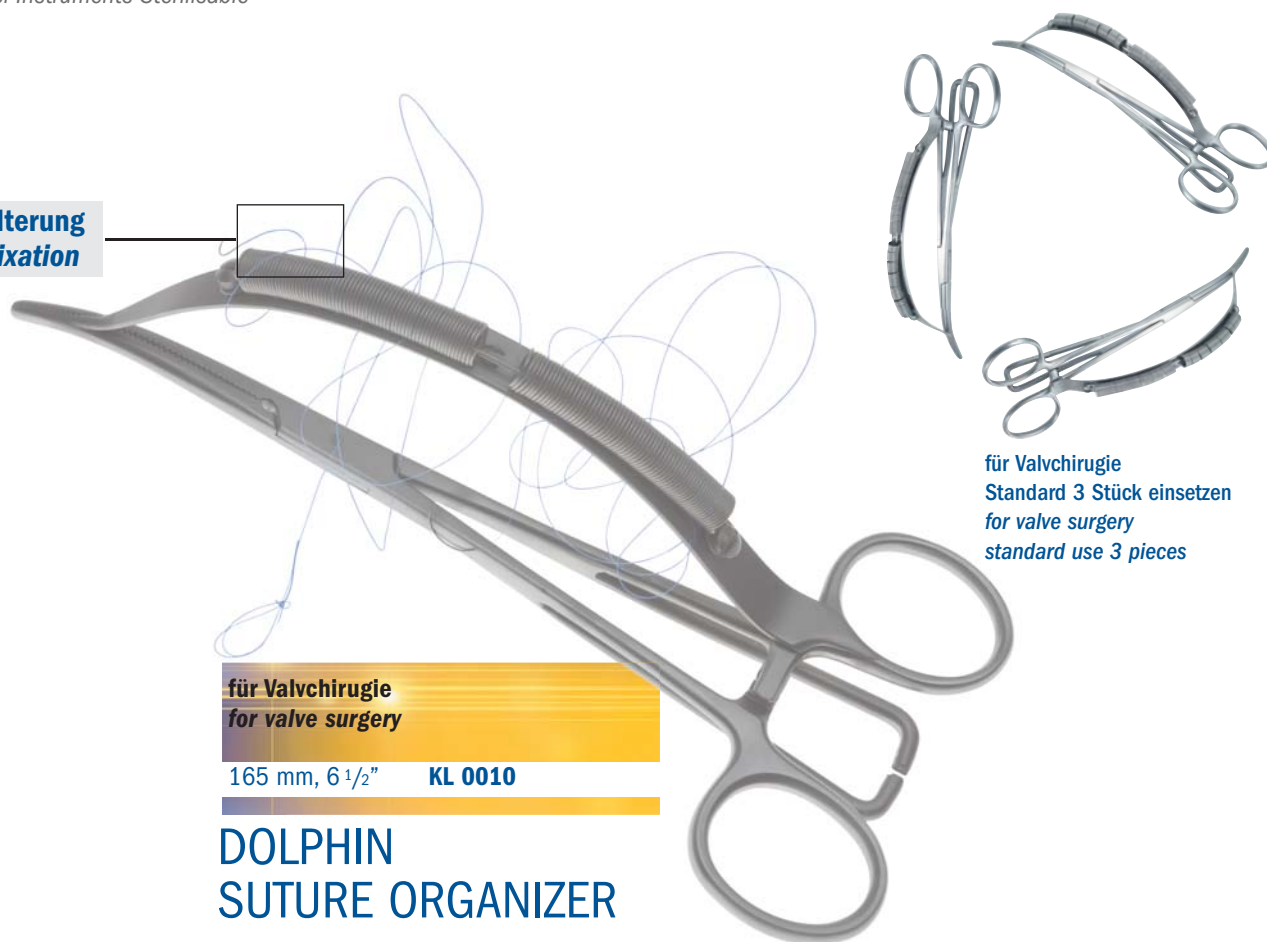

für Valvchirurgie  
for valve surgery

165 mm, 6 1/2" KL 0010

**DOLPHIN  
SUTURE ORGANIZER**

für Valvchirurgie  
Standard 3 Stück einsetzen  
for valve surgery  
standard use 3 pieces



	für Schlauch-Ø for tube Ø	für Aussen-Ø for outside Ø	
130 mm, 5"	1/4"	11 mm	<b>KL 0741</b>
140 mm, 5 1/2"	3/8"	14 mm	<b>KL 0742</b>
160 mm, 6 1/4"	1/2"	17 mm	<b>KL 0743</b>

**IORIO  
TUBE ORGANIZER**

Occludes the Vena Cava and allows blood flow through the cannula or catheter.

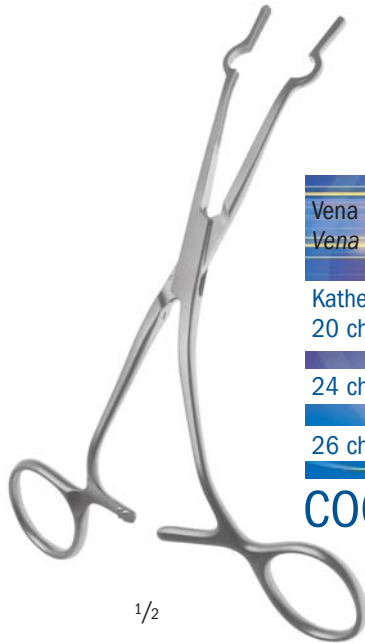

1/2



1/1

Vena Cava Klemme für Kinder, 160 mm, 6<sup>3</sup>/<sub>4</sub>"  
Vena Cava clamp for children, 160 mm, 6<sup>3</sup>/<sub>4</sub>"

Katheter-Größe/size of catheter  
20 ch. **GF 2622**

24 ch. **GF 2623**

26 ch. **GF 2624**

**COOLEY**



1/2



1/1

Vena Cava Klemme für Erwachsene, 200 mm, 8"  
Vena Cava clamp for adults, 200 mm, 8"

Katheter-Größe/size of catheter  
28 ch. **GF 2631**

30 ch. **GF 2632**

32 ch. **GF 2633**

34 ch. **GF 2634**

36 ch. **GF 2635**

38 ch. **GF 2636**

40 ch. **GF 2637**

**COOLEY**



gerade straight	
220 mm, 8 3/4"	<b>KL 0300</b>
265 mm, 10 1/2"	<b>KL 0320</b>

**ULRICH**



gebogen curved	
220 mm, 8 3/4"	<b>KL 0310</b>
265 mm, 10 1/2"	<b>KL 0330</b>

**ULRICH**

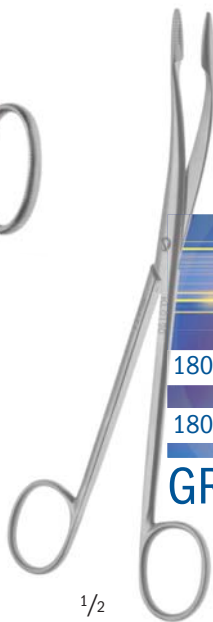

	ohne Sperre without ratchet	mit Sperre with ratchet
180 mm, 7" gerade/straight	<b>KL 0180</b>	<b>KL 0200</b>
180 mm, 7" gebogen/curved	<b>KL 0190</b>	<b>KL 0210</b>

**GROSS**



	ohne Sperre without ratchet	mit Sperre with ratchet
200 mm, 8" gerade/straight	<b>KL 0220</b>	<b>KL 0240</b>
200 mm, 8" gebogen/curved	<b>KL 0230</b>	<b>KL 0250</b>
265 mm, 10" gerade/straight	<b>KL 0260</b>	<b>KL 0280</b>
265 mm, 10" gebogen/curved	<b>KL 0270</b>	<b>KL 0290</b>
360 mm, 14" gerade/straight		<b>KL 0285</b>

**GROSS-MAIER**

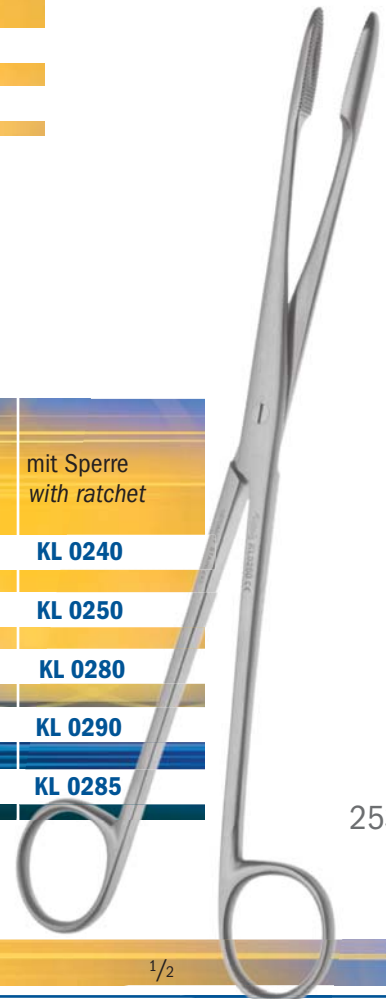

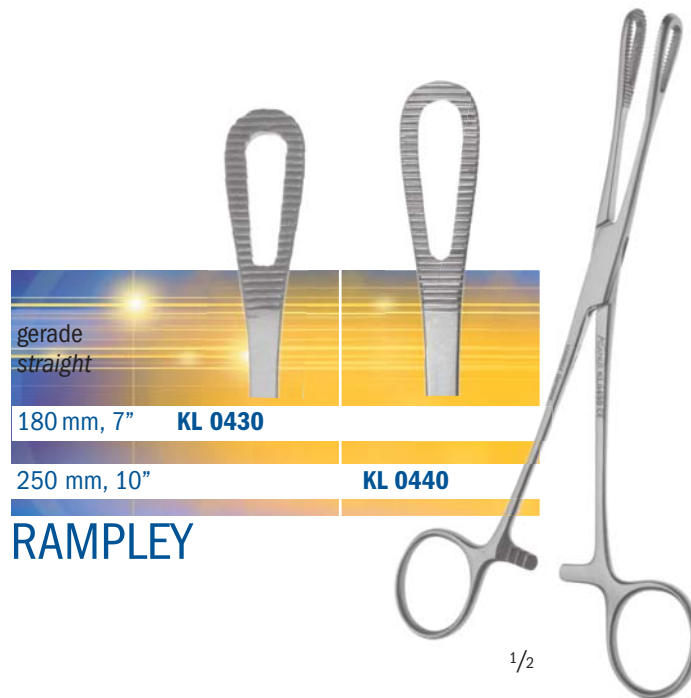
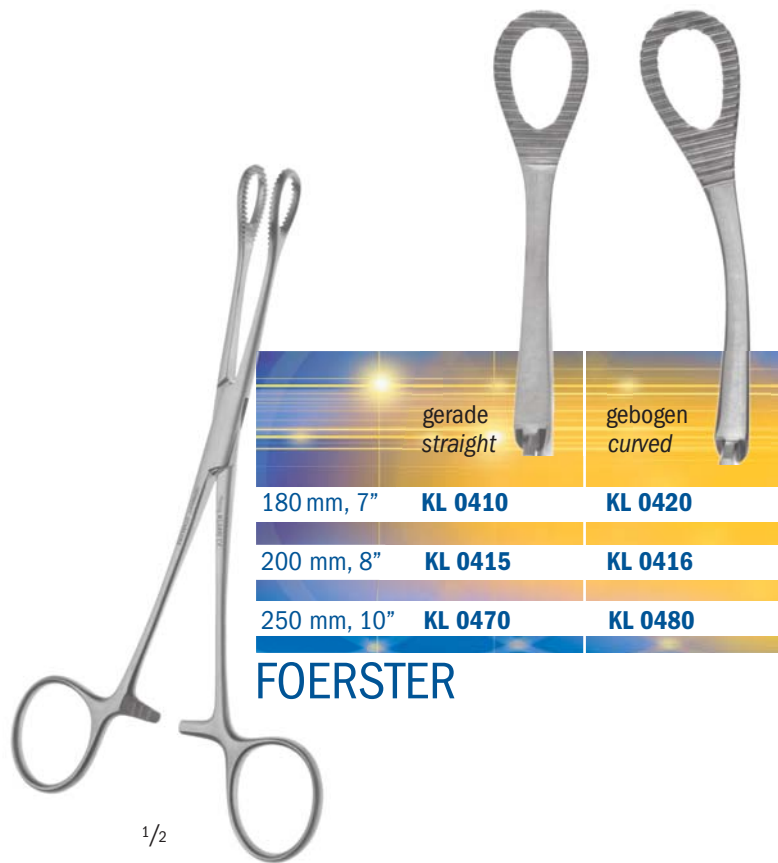



STEEL

1/1

<b>Mikro Mosquito delikat</b> <i>Micro Mosquito delicate</i>	anatomisch gerade <i>anatomic straight</i>	anatomisch gebogen <i>anatomic curved</i>	chirurgisch gerade 1x2 Zähne <i>surgical straight 1x2 teeth</i>	chirurgisch gebogen 1x2 Zähne <i>surgical curved 1x2 teeth</i>	anatomisch gerade <i>anatomic straight</i>	anatomisch gebogen <i>anatomic curved</i>
100 mm, 4"	KL 2296	KL 2297	KL 2224	KL 2225		
120 mm, 4 <sup>3</sup> / <sub>4</sub> "	KL 2202	KL 2203	KL 2204	KL 2205	KL 2208	KL 2209
150 mm, 6"	KL 2214	KL 2215	KL 2216	KL 2217		KL 2215K
150 mm, 6"		KL 2233 <small>Micro Delicate</small>				

JACOBSEN

elastisch, fein  
*elastic, fine*

PYRAMID SERRATED

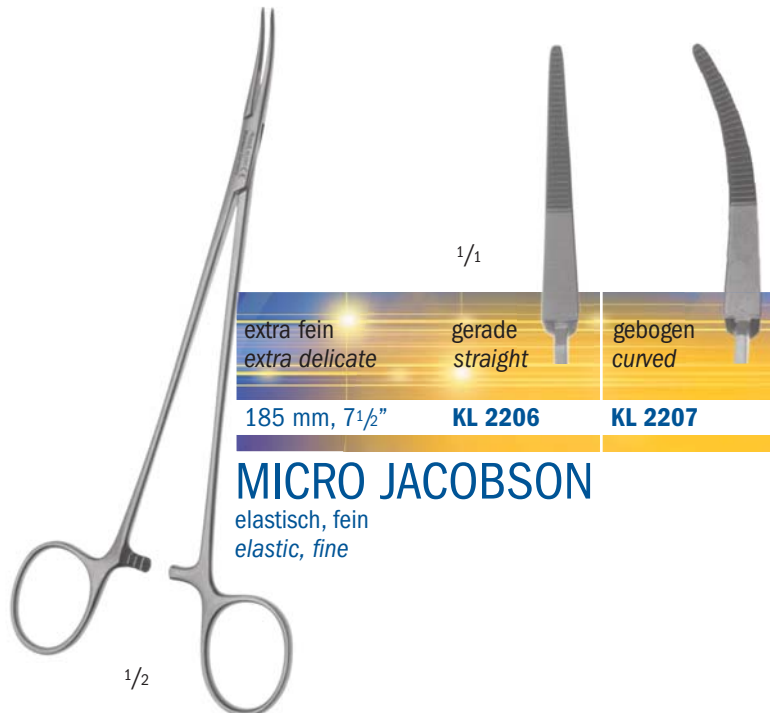
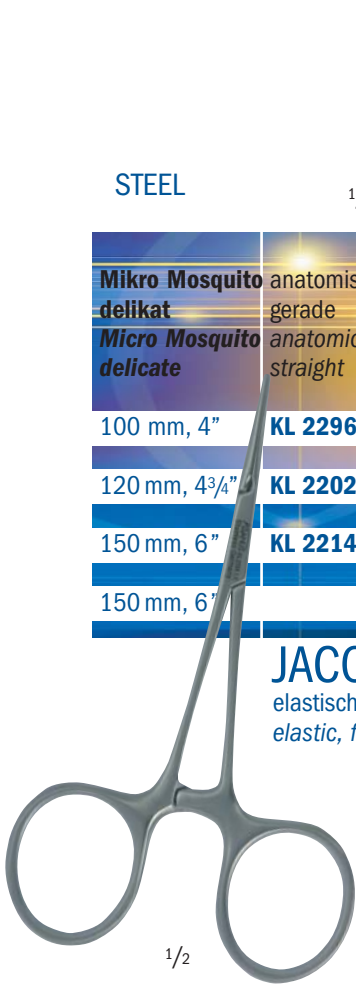

extra fein <i>extra delicate</i>	gerade <i>straight</i>	gebogen <i>curved</i>
185 mm, 7 <sup>1</sup> / <sub>2</sub> "	KL 2206	KL 2207

MICRO JACOBSON

elastisch, fein  
*elastic, fine*

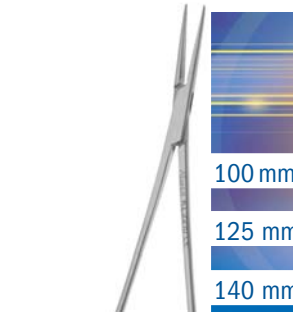

	gerade straight	gebogen curved	gerade straight 1x2 Zähne 1x2 teeth	gebogen curved 1x2 Zähne 1x2 teeth
100 mm, 4"	<b>KL 2186</b>	<b>KL 2187</b>	<b>KL 2288</b>	<b>KL 2289</b>
125 mm, 5"	<b>KL 2210</b>	<b>KL 2211</b>	<b>KL 2270</b>	<b>KL 2271</b>
140 mm, 5½"	<b>KL 2212</b>	<b>KL 2213</b>	<b>KL 2222</b>	<b>KL 2223</b>

**MICRO HALSTED-MOSQUITO**

1/2

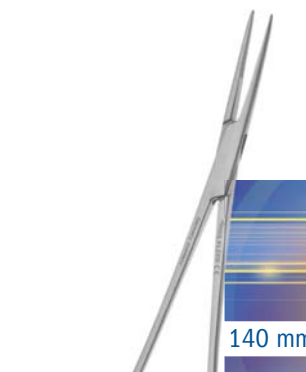

	gerade straight	gebogen curved
140 mm, 5½"	<b>KL 2310</b>	<b>KL 2311</b>

**PROVIDENCE-HOSPITAL**

1/2



	gerade straight	gebogen curved	gerade straight 1x2 Zähne 1x2 teeth	gebogen curved 1x2 Zähne 1x2 teeth
125 mm, 5"	<b>KL 2230</b>	<b>KL 2231</b>	<b>KL 2290</b>	<b>KL 2291</b>
185 mm, 7¼"	<b>KL 2620</b>	<b>KL 2621</b>	<b>KL 2690</b>	<b>KL 2700</b>
200 mm, 8"			<b>KL 2710</b>	<b>KL 2711</b>

**HALSTED-MOSQUITO**

1/2

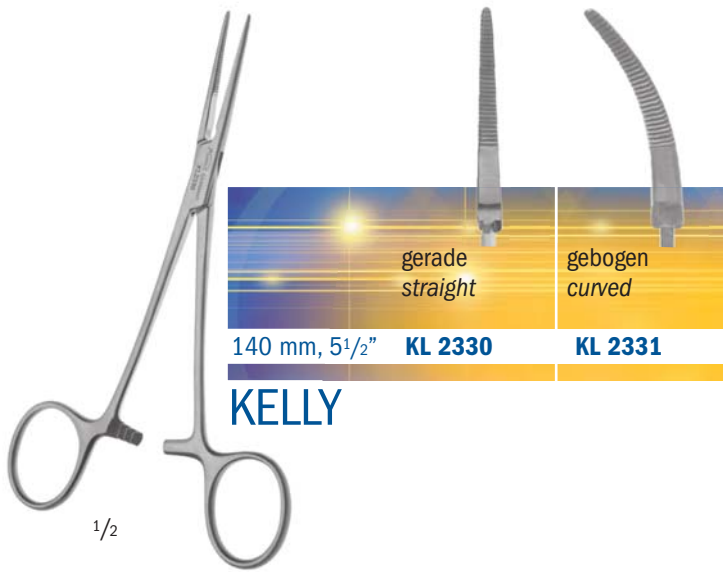

**KELLY**

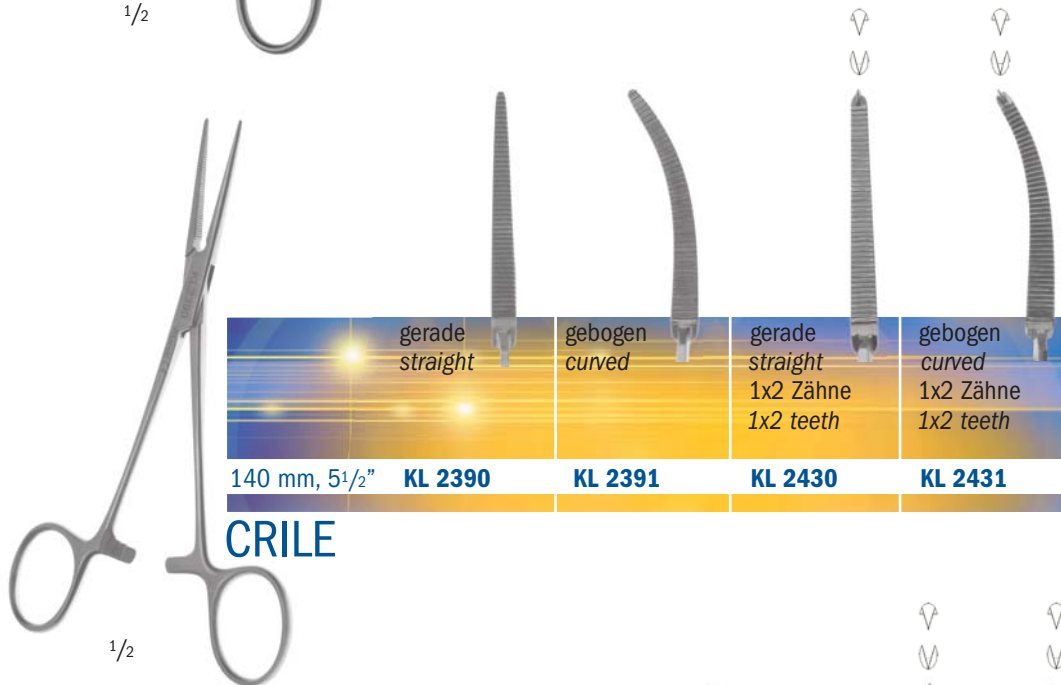

**CRILE**

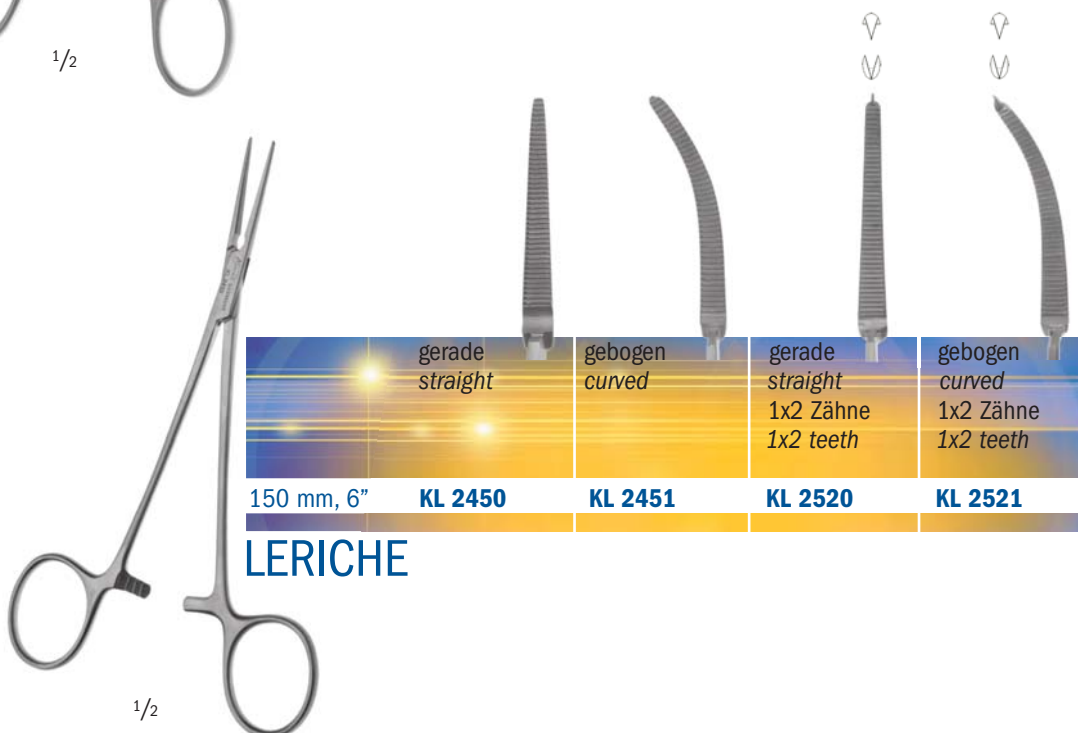

**LERICHE**

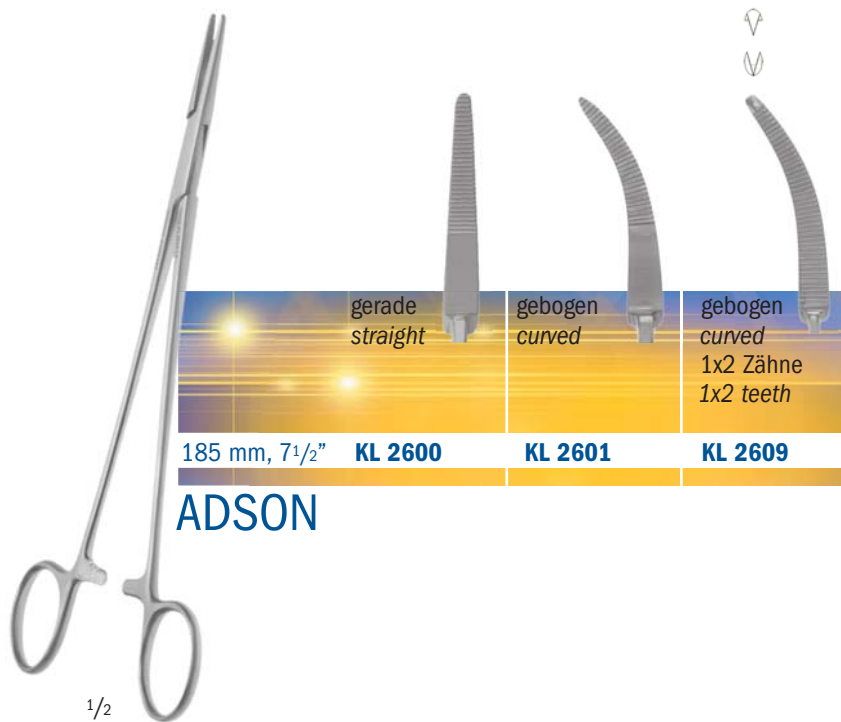



	gerade straight	gebogen curved	gerade straight 1x2 Zähne 1x2 teeth	gebogen curved 1x2 Zähne 1x2 teeth
200 mm, 8"	<b>KL 2888</b>	<b>KL 2889</b>	<b>KL 2838</b>	<b>KL 2839</b>
245 mm, 9 <sup>3</sup> / <sub>4</sub> "	<b>KL 2890</b>	<b>KL 2891</b>	<b>KL 2840</b>	<b>KL 2841</b>

**BENGOLA**

1/2

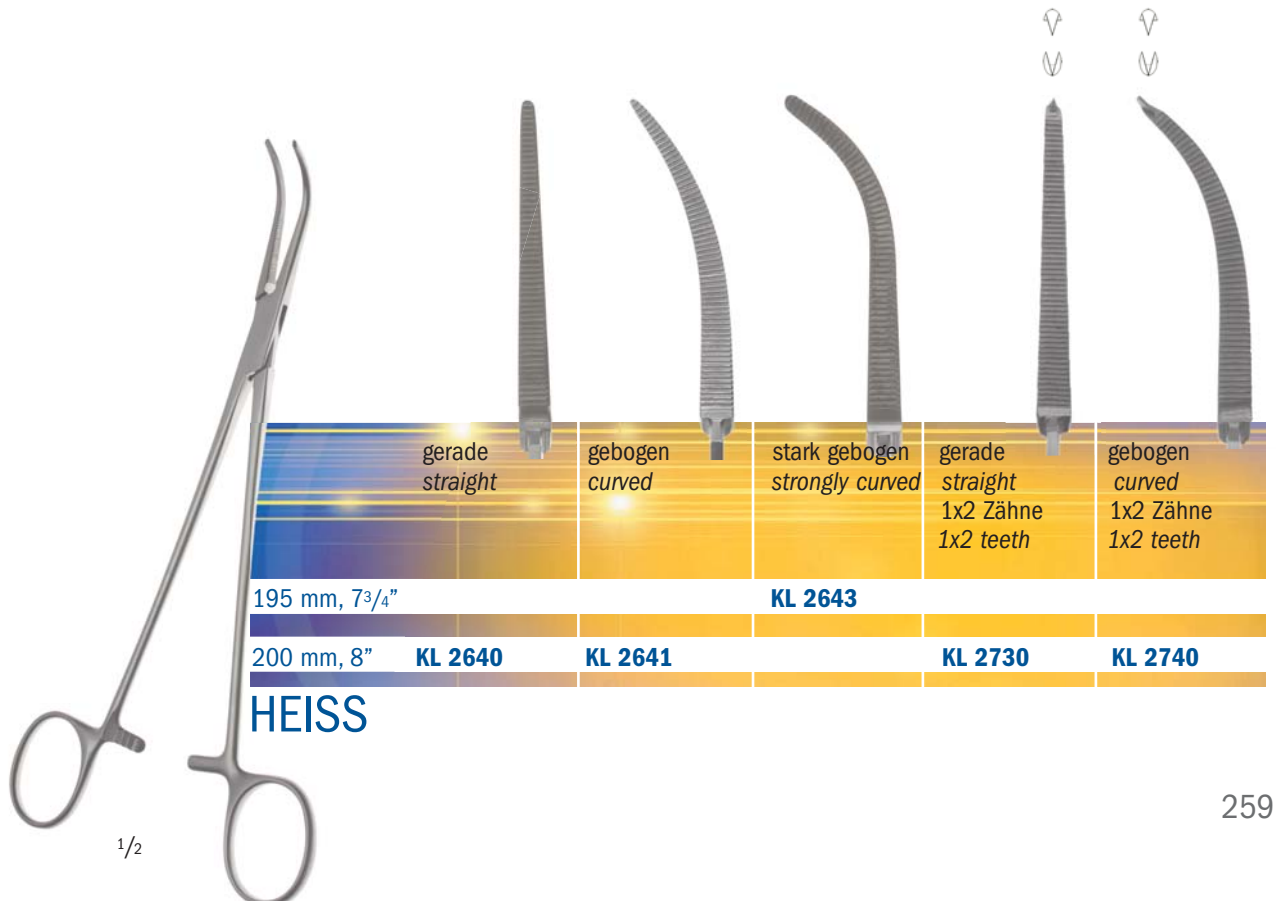

	gerade straight	gebogen curved	stark gebogen strongly curved	gerade straight 1x2 Zähne 1x2 teeth	gebogen curved 1x2 Zähne 1x2 teeth
195 mm, 7 <sup>3</sup> / <sub>4</sub> "			<b>KL 2643</b>		
200 mm, 8"	<b>KL 2640</b>	<b>KL 2641</b>		<b>KL 2730</b>	<b>KL 2740</b>

**HEISS**

1/2

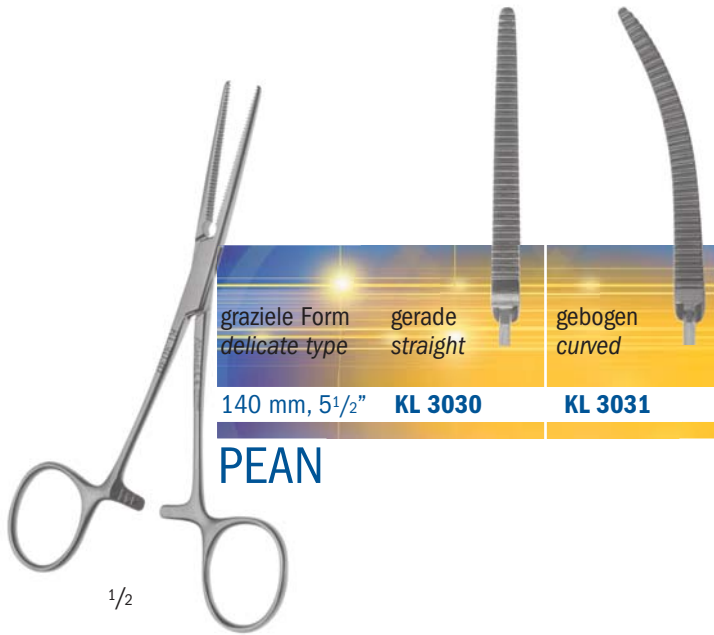

**PEAN**

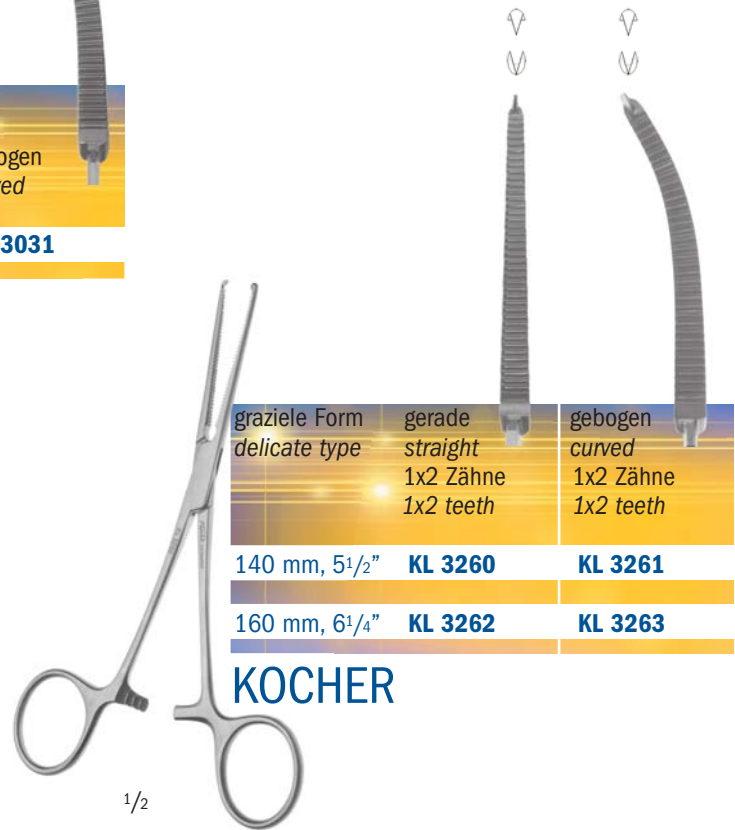

**KOCHER**

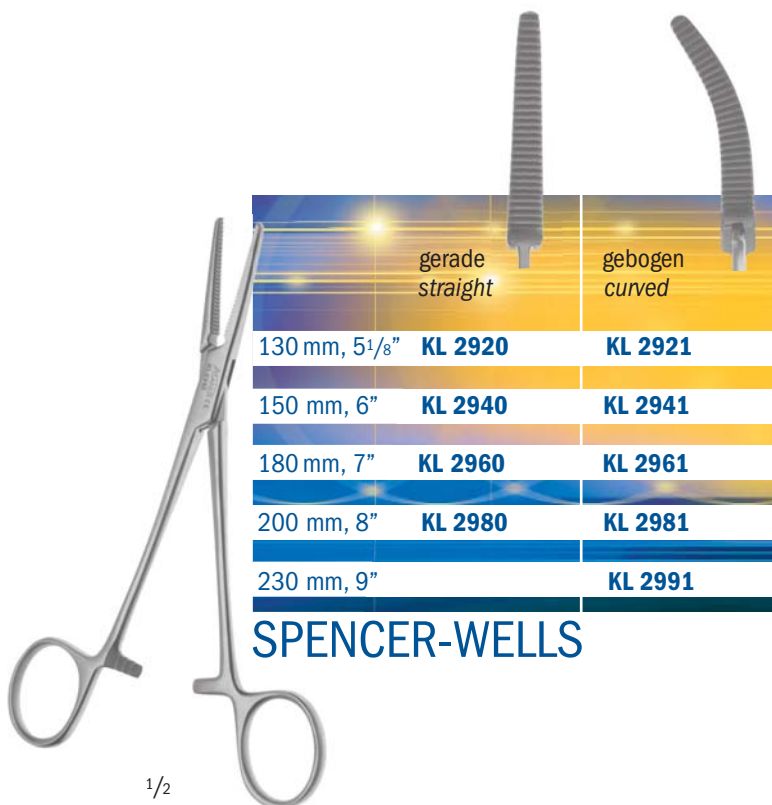

**SPENCER-WELLS**

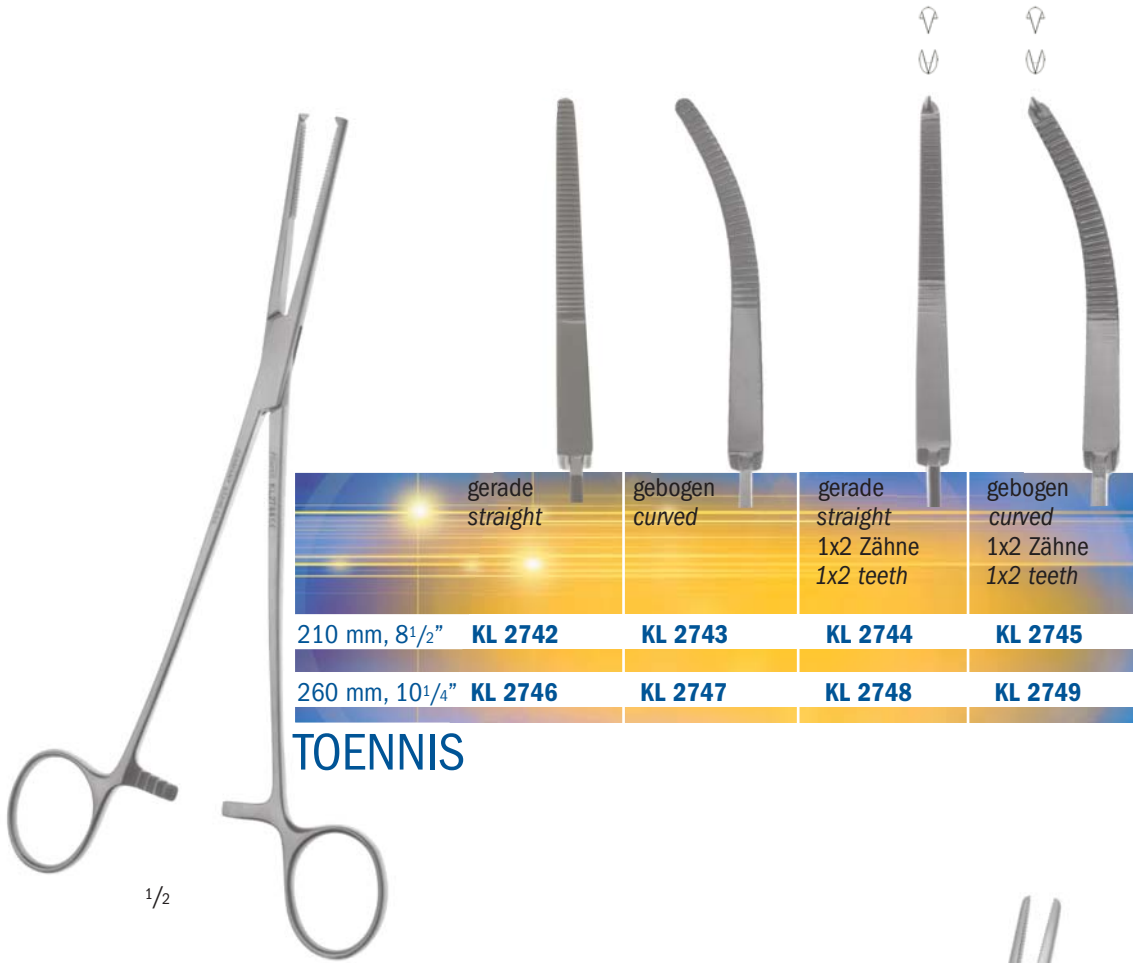

	gerade straight	gebogen curved	gerade straight 1x2 Zähne 1x2 teeth	gebogen curved 1x2 Zähne 1x2 teeth
210 mm, 8 <sup>1</sup> / <sub>2</sub> "	<b>KL 2742</b>	<b>KL 2743</b>	<b>KL 2744</b>	<b>KL 2745</b>
260 mm, 10 <sup>1</sup> / <sub>4</sub> "	<b>KL 2746</b>	<b>KL 2747</b>	<b>KL 2748</b>	<b>KL 2749</b>

**TOENNIS**

1/2

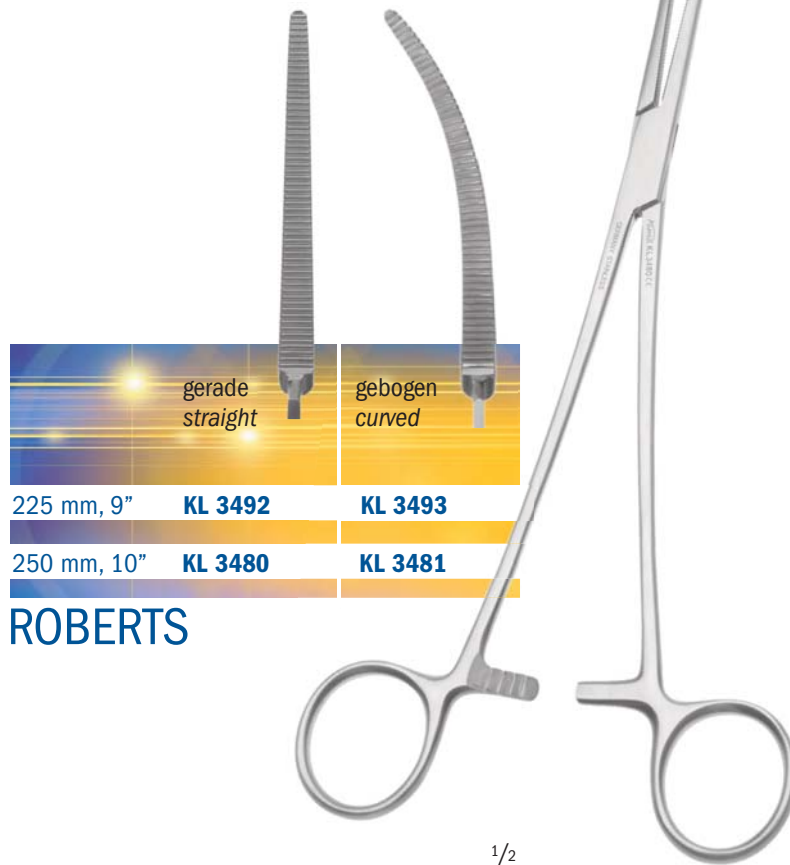

	gerade straight	gebogen curved
225 mm, 9"	<b>KL 3492</b>	<b>KL 3493</b>
250 mm, 10"	<b>KL 3480</b>	<b>KL 3481</b>

**ROBERTS**

1/2

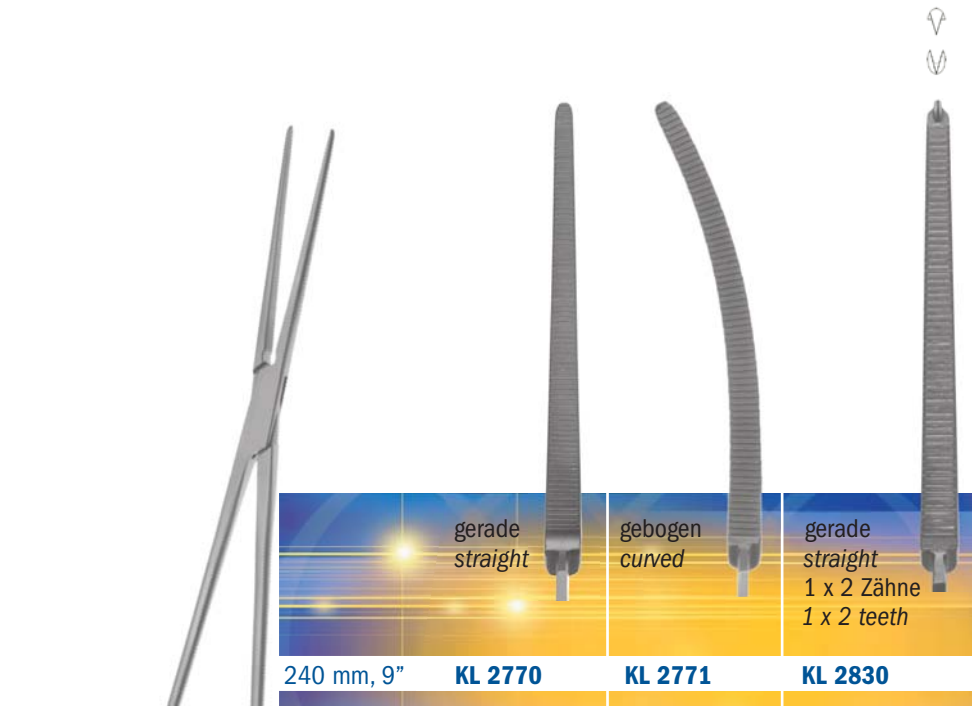

**SAROT**



**ZENKER**



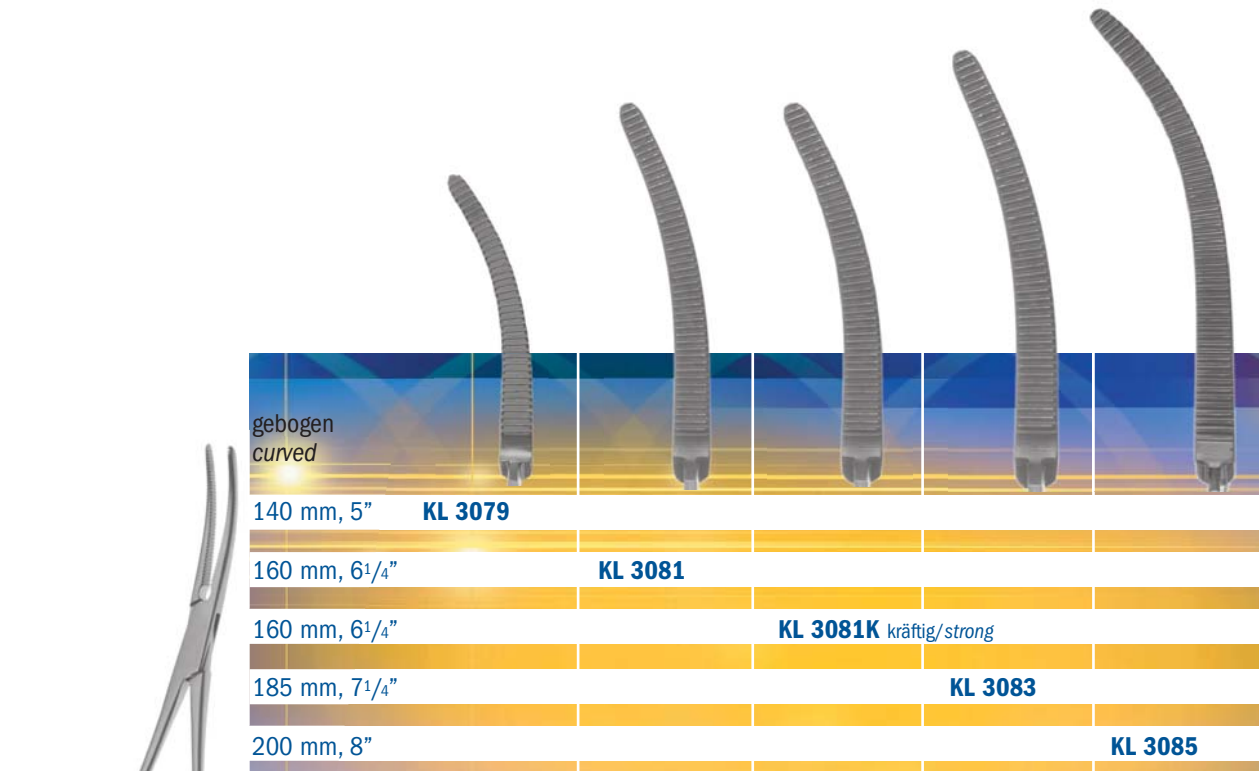



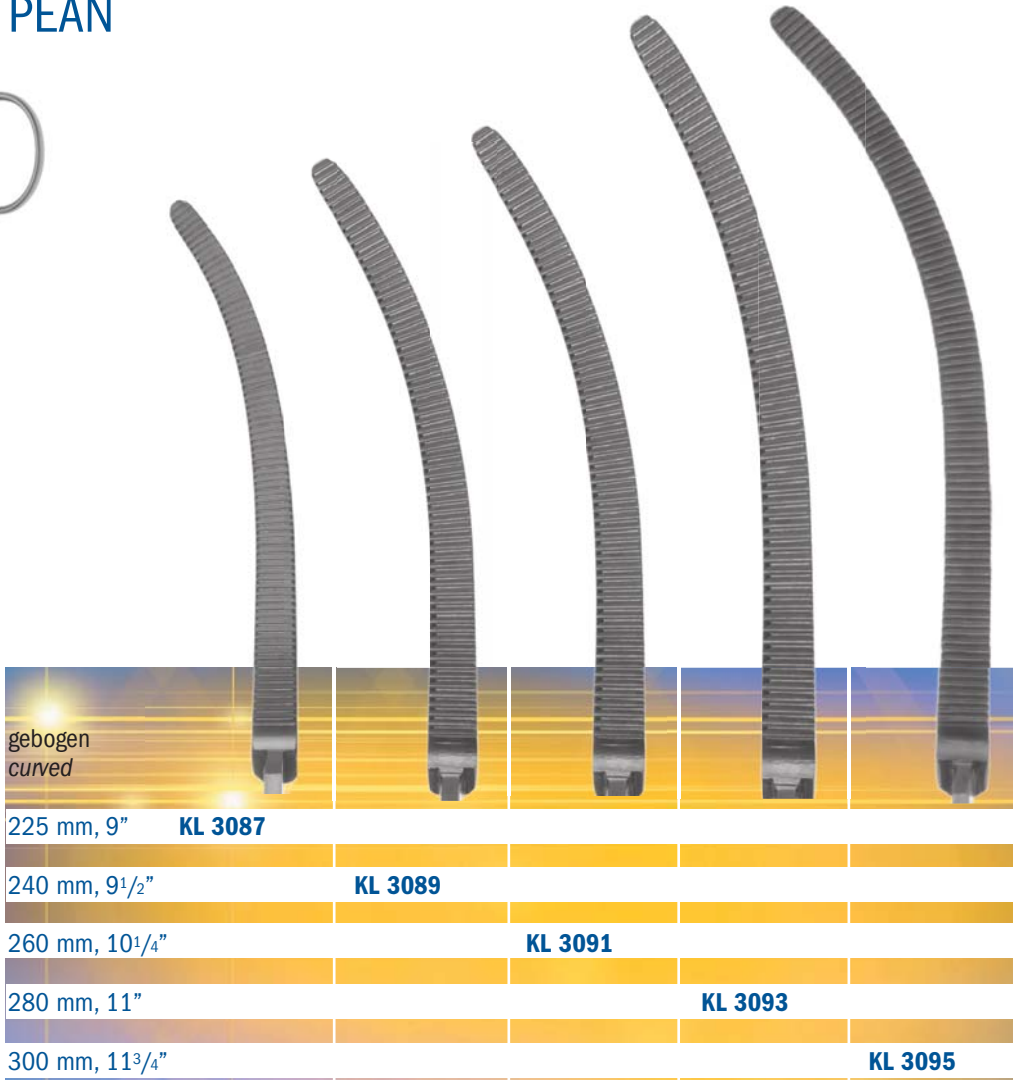

**PEAN**

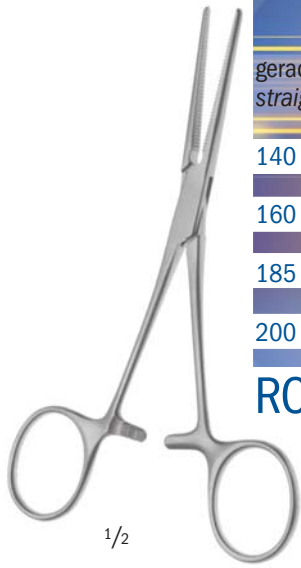





**PEAN**

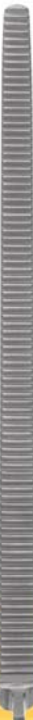

gerade straight				
	140 mm, 5"	<b>KL 3078</b>		
	160 mm, 6 <sup>1</sup> / <sub>4</sub> "		<b>KL 3080</b>	
	185 mm, 7 <sup>1</sup> / <sub>4</sub> "			<b>KL 3082</b>
	200 mm, 8"			<b>KL 3084</b>

**ROCHESTER-PEAN**

gerade straight					
	225 mm, 9"	<b>KL 3086</b>			
	240 mm, 9 <sup>1</sup> / <sub>2</sub> "		<b>KL 3088</b>		
	260 mm, 10 <sup>1</sup> / <sub>4</sub> "			<b>KL 3090</b>	
	280 mm, 11"				<b>KL 3092</b>
	300 mm, 11 <sup>3</sup> / <sub>4</sub> "				<b>KL 3094</b>

**ROCHESTER-PEAN**



gewinkelt, 1 x 2 Zähne  
*curved, 1 x 2 teeth*

140 mm, 5"	<b>KL 3319</b>		
160 mm, 6 <sup>1</sup> / <sub>4</sub> "		<b>KL 3321</b>	
180 mm, 7"			<b>KL 3323</b>
200 mm, 8"			<b>KL 3325</b>

**KOCHER-OSHSNER**

gewinkelt, 1 x 2 Zähne  
*curved, 1 x 2 teeth*

220 mm, 9"	<b>KL 3327</b>		
240 mm, 9 <sup>1</sup> / <sub>2</sub> "		<b>KL 3329</b>	
265 mm, 10 <sup>1</sup> / <sub>4</sub> "			<b>KL 3331</b>
300 mm, 11 <sup>3</sup> / <sub>4</sub> "			<b>KL 3335</b>

**KOCHER-OSHSNER**

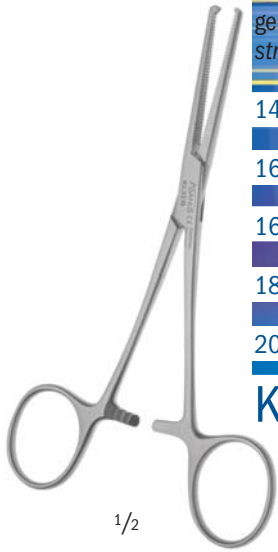

gerade, 1 x 2 Zähne straight, 1 x 2 teeth					
140 mm, 5"	<b>KL 3318</b>				
160 mm, 6 <sup>1</sup> / <sub>4</sub> "		<b>KL 3320</b>			
160 mm, 6 <sup>1</sup> / <sub>4</sub> "			<b>KL 3320K</b> kräftig/strong		
180 mm, 7"				<b>KL 3322</b>	
200 mm, 8"					<b>KL 3324</b>

**KOCHER-OCHSNER**

gerade, 1 x 2 Zähne straight, 1 x 2 teeth				
220 mm, 9"	<b>KL 3326</b>			
240 mm, 9 <sup>1</sup> / <sub>2</sub> "		<b>KL 3328</b>		
265 mm, 10 <sup>1</sup> / <sub>4</sub> "			<b>KL 3330</b>	
300 mm, 11 <sup>3</sup> / <sub>4</sub> "				<b>KL 3332</b>

**KOCHER-OCHSNER**

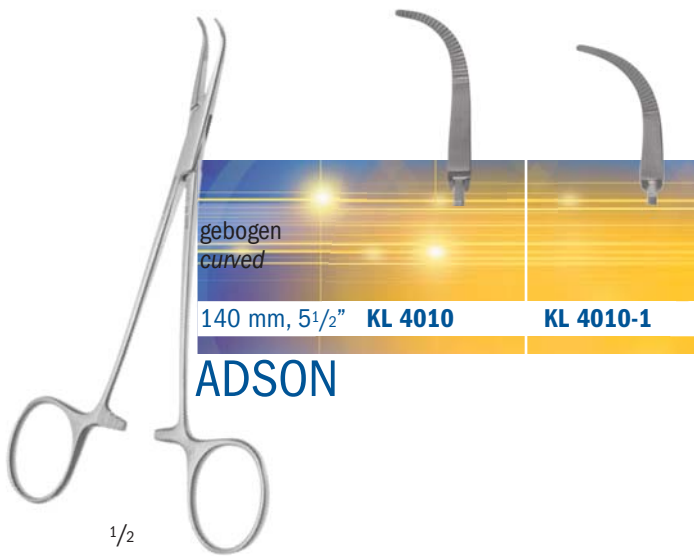

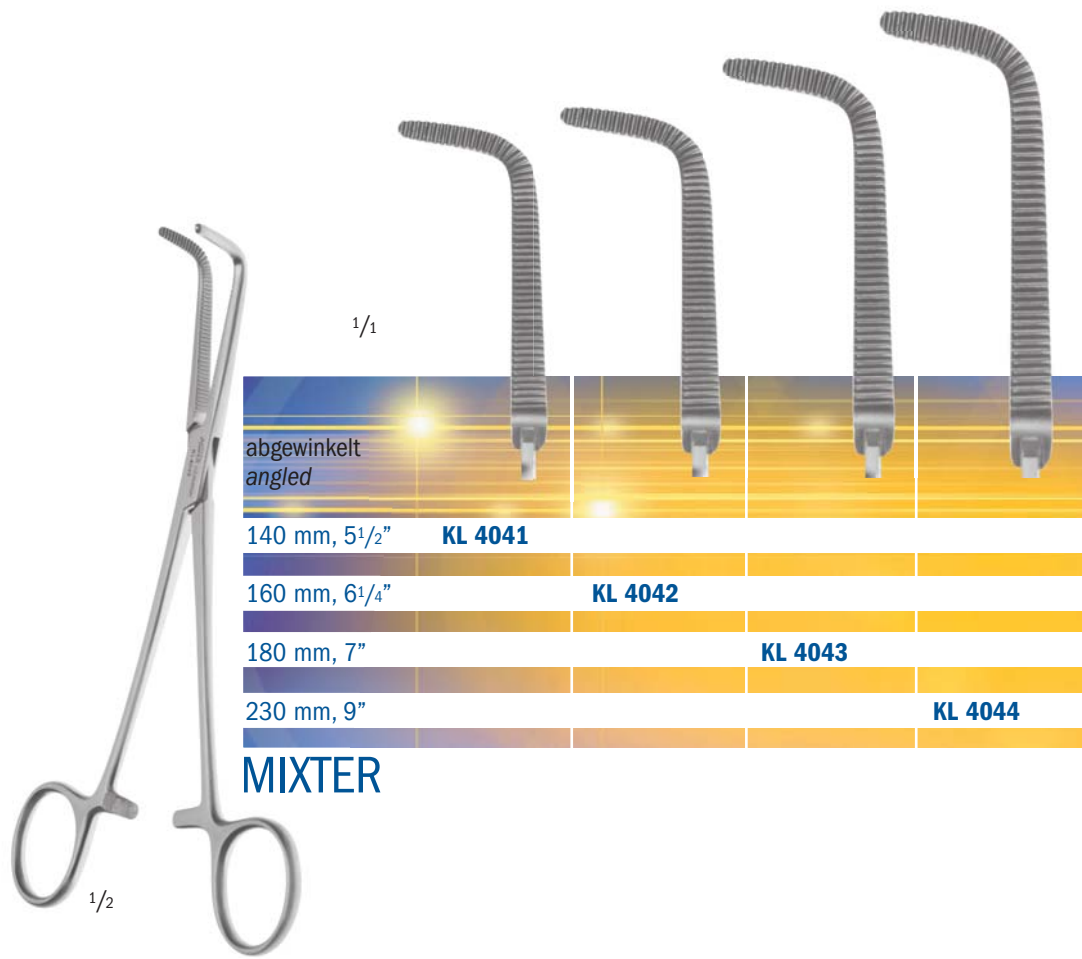

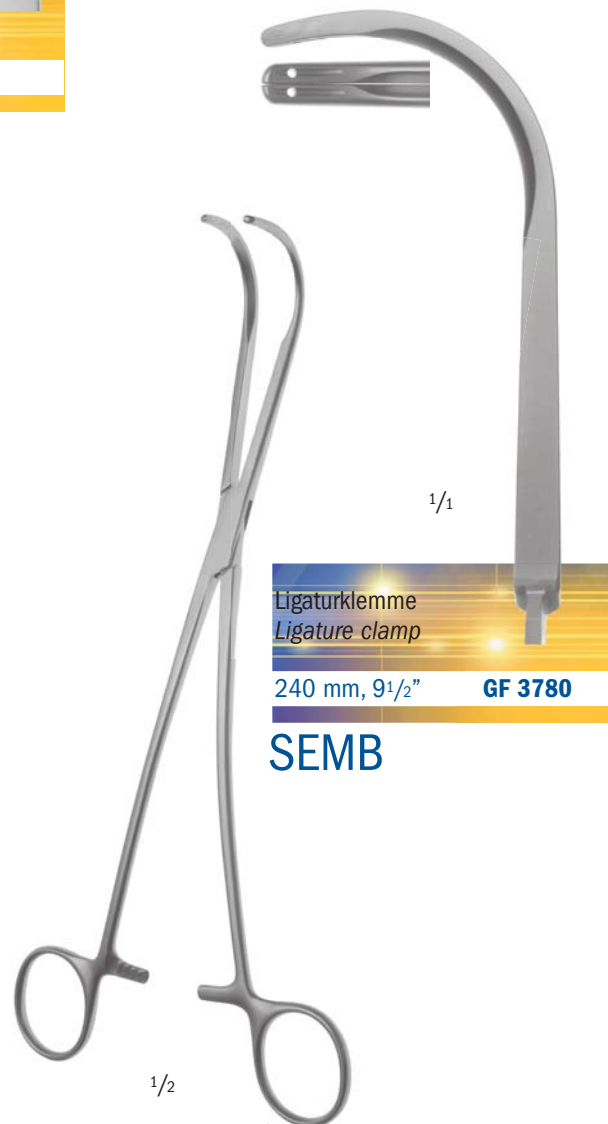
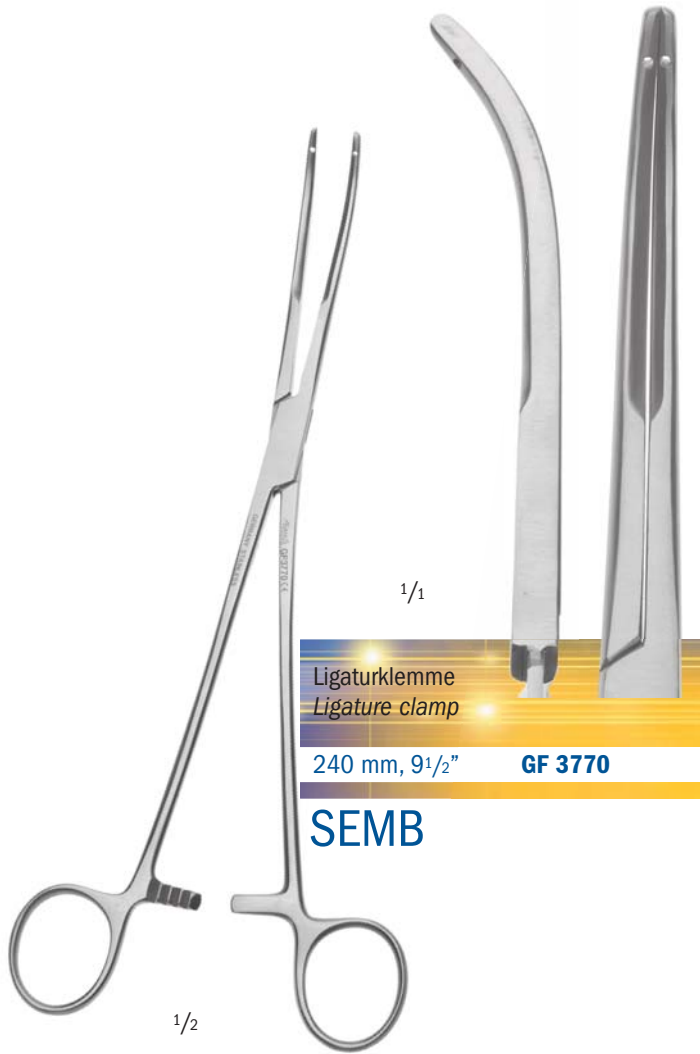



**S-gebogen**  
**S-curved**

150 mm, 6"

**KL 2593**

185 mm, 7<sup>1</sup>/<sub>4</sub>"

**KL 2594**

**HOLLE**

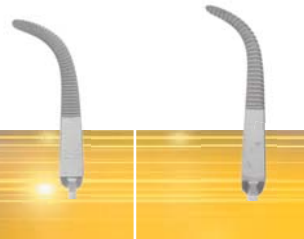

fein, elastisch  
*fine, elastic*

gerade  
*straight*

gebogen  
*curved*

150 mm, 6"

**KL 2242**

**KL 2243**

**STRELI**

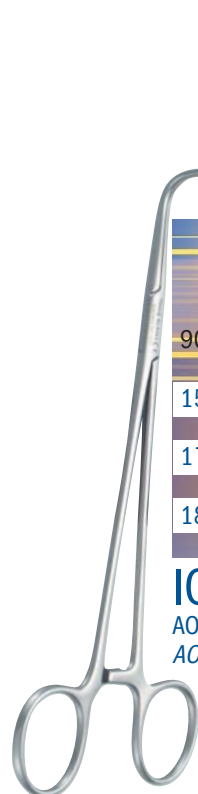

	MICRO <i>for Neonatal</i> Aorta Diameter 8-10 mm	MINI <i>for Infants</i> Aorta Diameter 14-16 mm	STANDARD <i>for Teens</i> Aorta Diameter 20-26 mm
90° angled			
150 mm, 6"	<b>KL 4051</b>		
170 mm, 6 <sup>3</sup> / <sub>4</sub> "		<b>KL 4052</b>	
180 mm, 7"			<b>KL 4053</b>

**IORIO**

AORTA PRÄPARIERKLEMME FÜR DIE KINDERCHIRURGIE  
AORTA DISSECTING CLAMPS FOR PEDIATRIC SURGERY



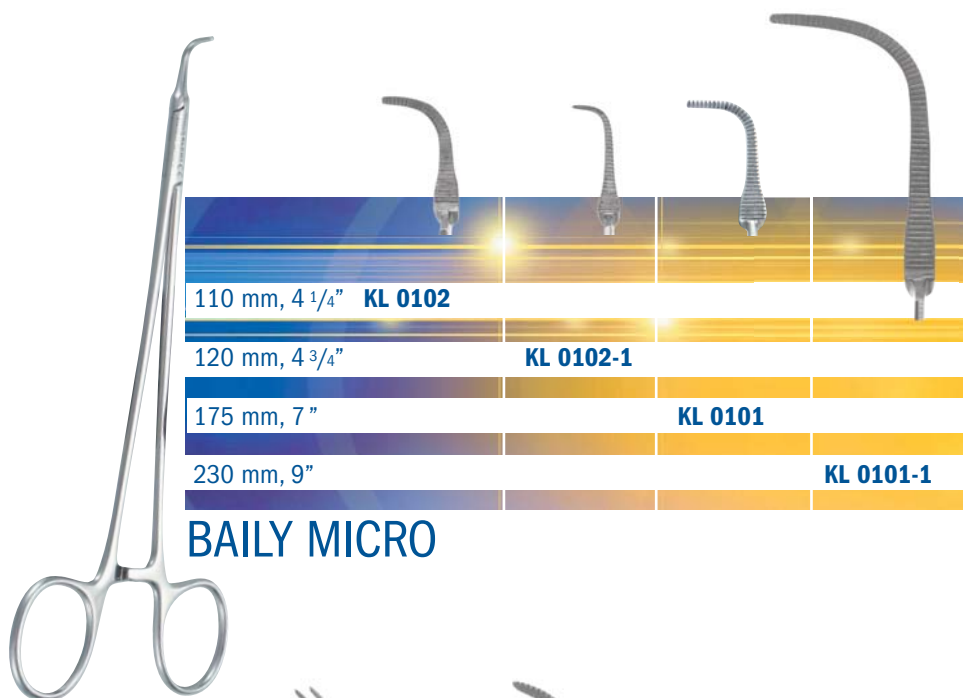

110 mm, 4 1/4"	<b>KL 0102</b>
120 mm, 4 3/4"	<b>KL 0102-1</b>
175 mm, 7"	<b>KL 0101</b>
230 mm, 9"	<b>KL 0101-1</b>

**BAILY MICRO**

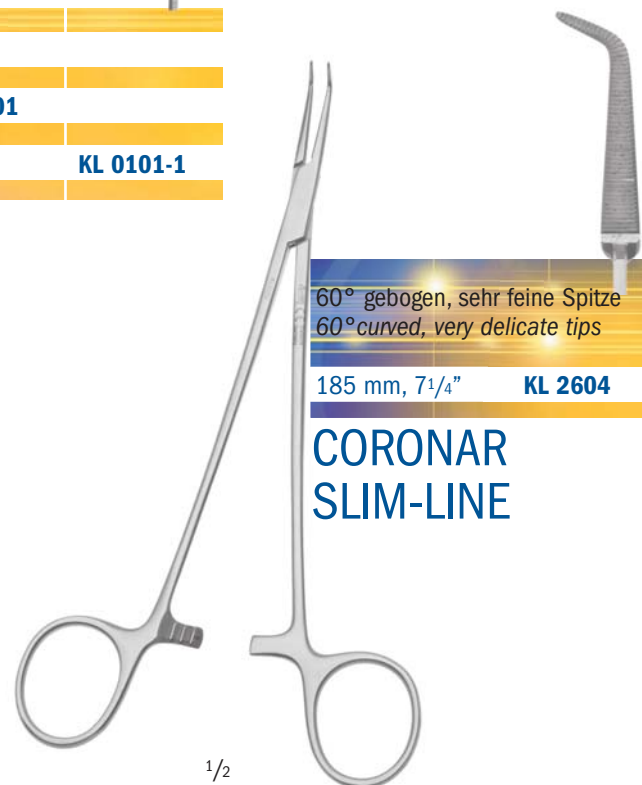

60° gebogen, sehr feine Spitze  
60° curved, very delicate tips

185 mm, 7 1/4" **KL 2604**

**CORONAR SLIM-LINE**



stark gebogen  
strongly curved

150 mm, 6" **KL 4384**

**MICRO-OVERHOLT**



gebogen  
curved

180 mm, 7" **KL 2607**

**ADSON**



gebogen, delicat  
curved, delicate

185 mm, 7 1/4" **KL 2602**

**ADSON**

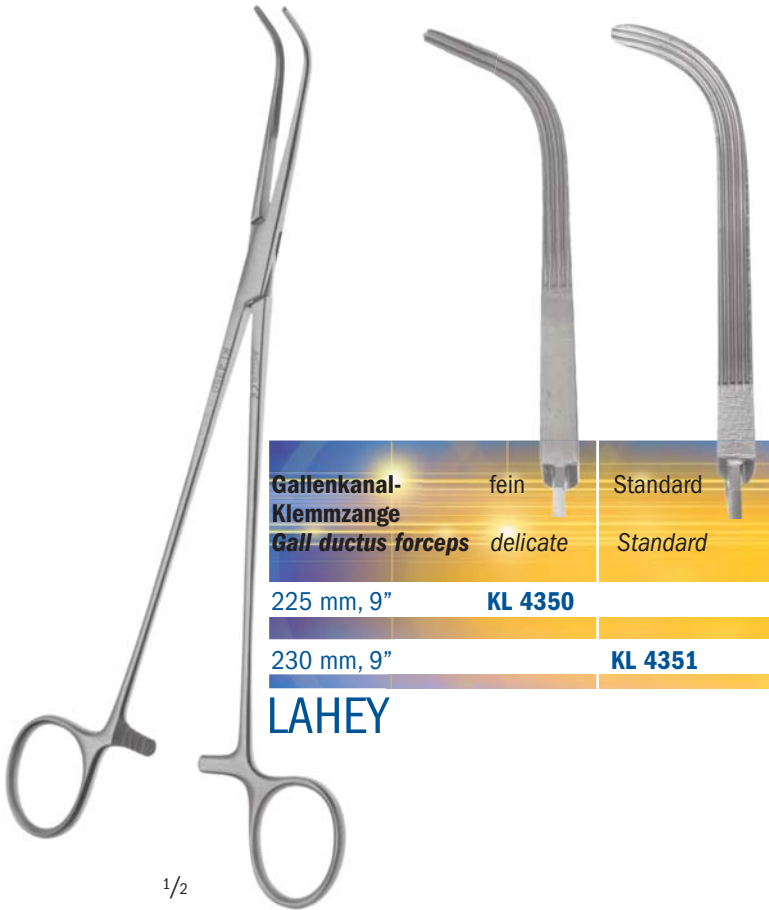

<b>Gallenkanal-Klemmzange</b>	fein	Standard
<b>Gall ductus forceps</b>	delicate	Standard

225 mm, 9" **KL 4350**

230 mm, 9" **KL 4351**

**LAHEY**

1/2



gebogen  
curved

180 mm, 7" **KL 2623**

**HALSTED-FINO**

1/2



gebogen  
curved

180 mm, 7" **KL 4040**

**BABY-MIXTER**

1/2

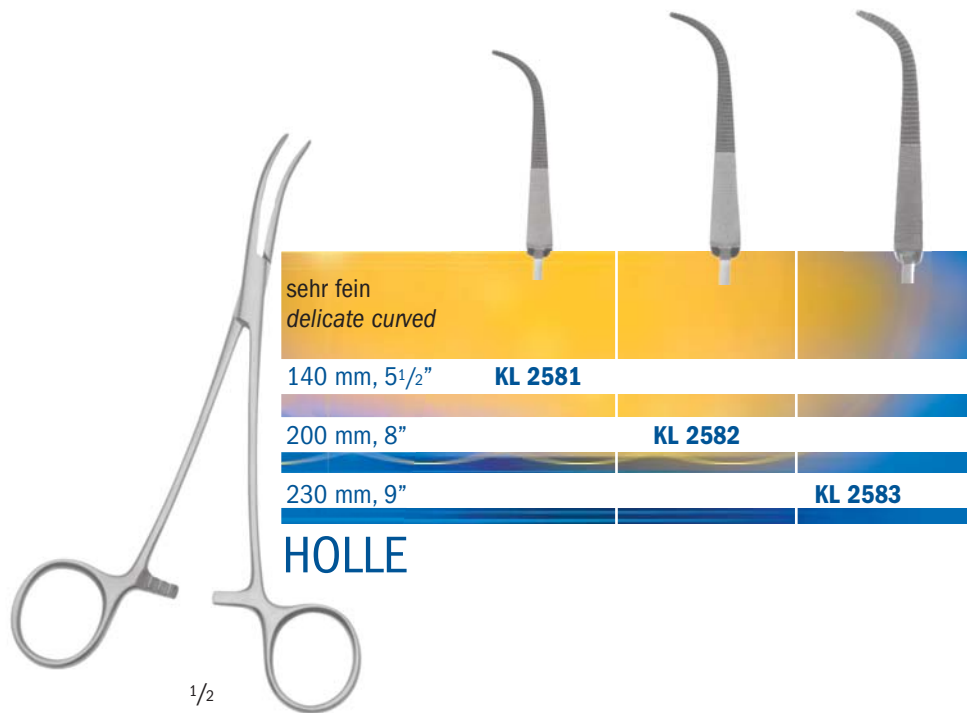

gebogen curved			
130 mm, 5"	<b>KL 4111</b>		
160 mm, 6 <sup>1</sup> / <sub>4</sub> "		<b>KL 4112</b>	
185 mm, 7 <sup>1</sup> / <sub>4</sub> "			<b>KL 4113</b>
200 mm, 8"			<b>KL 4114</b>

**DE BAKEY MIXTER**

gebogen curved		
230 mm, 9"	<b>KL 4115</b>	
250 mm, 10"		<b>KL 4116</b>
280 mm, 11"		<b>KL 4117</b>





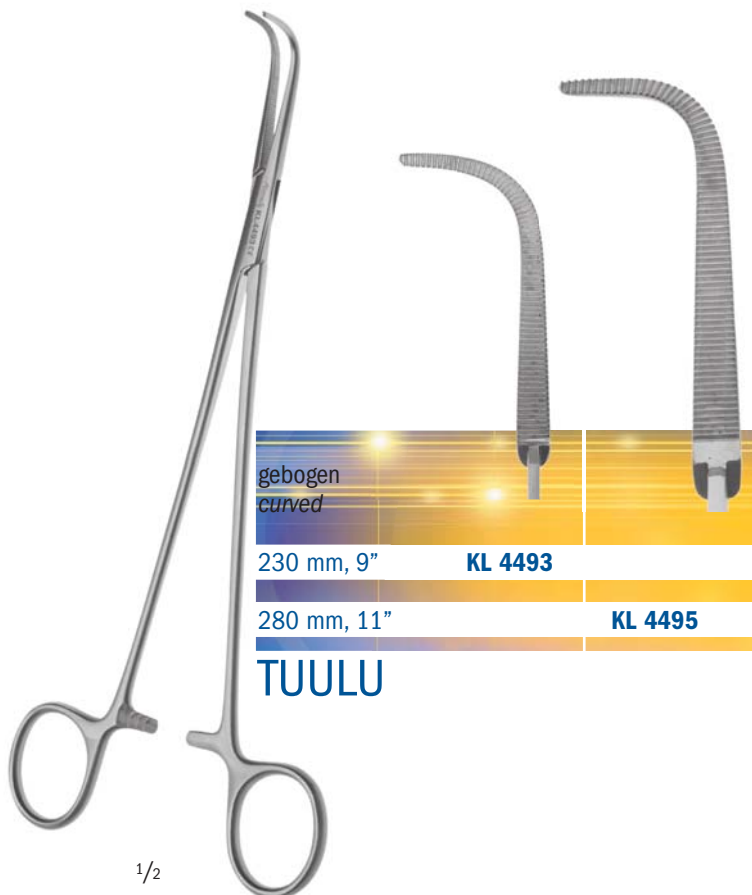

**DE BAKEY MIXTER**

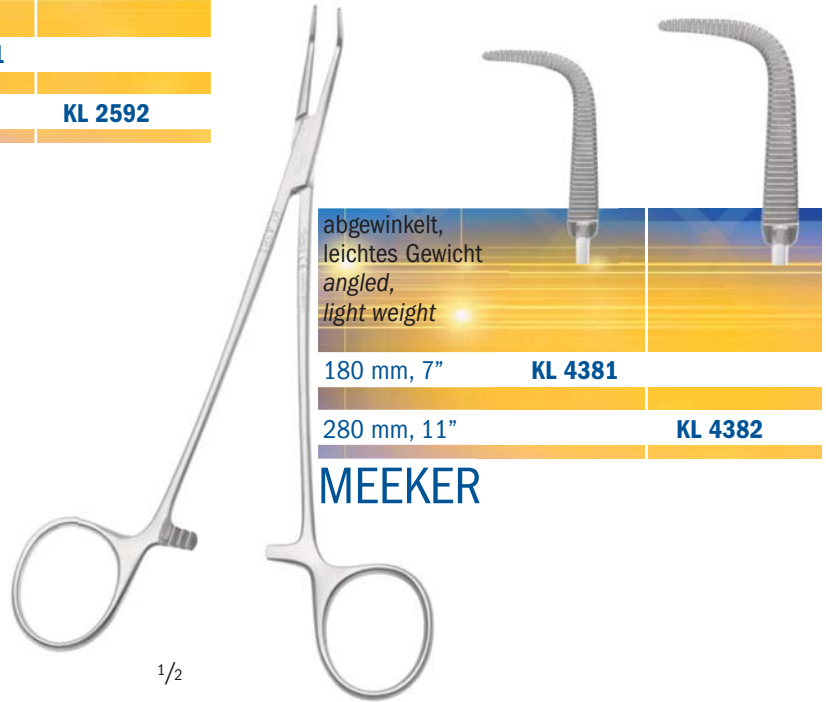
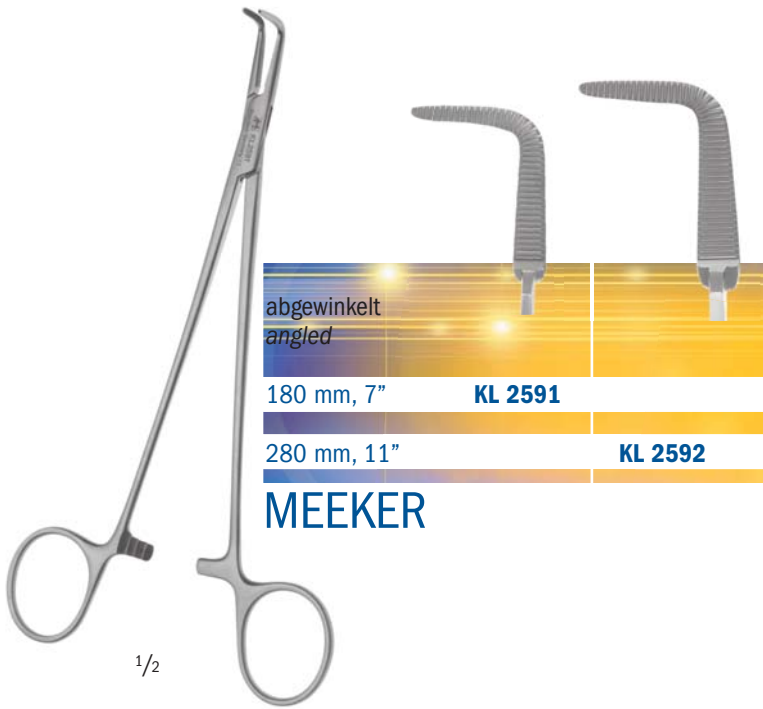

1/1







gebogen curved							
130 mm, 5 <sup>1</sup> / <sub>8</sub> "	<b>KL 4479</b>						
160 mm, 6 <sup>1</sup> / <sub>4</sub> "		<b>KL 4480</b>					
180 mm, 7"			<b>KL 4481</b>				
200 mm, 8"				<b>KL 4482</b>			
230 mm, 9"					<b>KL 4483</b>		
250 mm, 10"						<b>KL 4484</b>	
280 mm, 11"							<b>KL 4485</b>

GEMINI

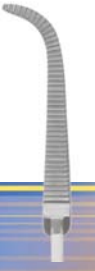

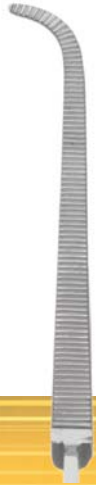
gebogen curved				
180 mm, 7"	<b>KL 4471</b>			
220 mm, 8 <sup>3</sup> / <sub>4</sub> "		<b>KL 4473</b>		
250 mm, 10"			<b>KL 4474</b>	
280 mm, 11"				<b>KL 4475</b>

GEMINI MINI

gebogen curved						
210 mm, 8 1/2"	<b>KL 4400</b>					
215 mm, 8 1/4"		<b>KL 4410</b>				
220 mm, 8 3/4"			<b>KL 4420</b>			
225 mm, 9"				<b>KL 4430</b>		
225 mm, 9"					<b>KL 4440</b>	
295 mm, 12"						<b>KL 4450</b>

**OVERHOLT  
SLIM LINE**





1/2

gebogen curved			
300 mm, 12"	<b>KL 4455</b>		
295 mm, 12"		<b>KL 4460</b>	
300 mm, 12"			<b>KL 4470</b>



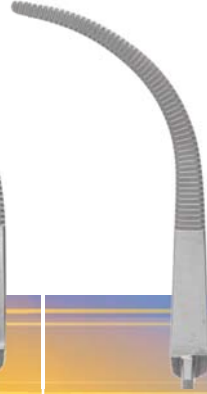

S-gebogen S-curved				
185 mm, 7 <sup>1</sup> / <sub>4</sub> "	<b>KL 4070</b>			
210 mm, 8 <sup>1</sup> / <sub>4</sub> "		<b>KL 4080</b>		
215 mm, 8 <sup>1</sup> / <sub>2</sub> "			<b>KL 4090</b>	
220 mm, 8 <sup>3</sup> / <sub>4</sub> "				<b>KL 4100</b>

**OVERHOLT-S**



fein delicate		
260 mm, 10 <sup>1</sup> / <sub>4</sub> "	<b>KL 4530</b>	
270 mm, 10 <sup>3</sup> / <sub>4</sub> "		<b>KL 4540</b>

**OVERHOLT  
DELICATE**

gebogen curved	Fig.0	Fig.1	Fig.2	Fig.3	Fig.4	Fig.5	Fig.6
195 mm, 7 <sup>3</sup> / <sub>4</sub> "	<b>KL 4120</b>						
210 mm, 8 <sup>3</sup> / <sub>4</sub> "		<b>KL 4130</b>			<b>KL 4160</b>		
220 mm, 8 <sup>3</sup> / <sub>4</sub> "			<b>KL 4140</b>				
225 mm, 9"							<b>KL 4180</b>
230 mm, 9"				<b>KL 4150</b>		<b>KL 4170</b>	
240 mm, 9 <sup>1</sup> / <sub>2</sub> "			<b>KL 4141</b>				<b>KL 4181</b>
260 mm, 10 <sup>1</sup> / <sub>4</sub> "		<b>KL 4190</b>					
270 mm, 10 <sup>3</sup> / <sub>4</sub> "	<b>KL 4184</b>		<b>KL 4200</b>		<b>KL 4220</b>		<b>KL 4232</b>
275 mm, 10 <sup>3</sup> / <sub>4</sub> "				<b>KL 4210</b>			
280 mm, 11"						<b>KL 4230</b>	
350 mm, 14"			<b>KL 4204</b>				

## OVERHOLT- GEISSENDOERFER



<sup>1</sup>/<sub>2</sub>

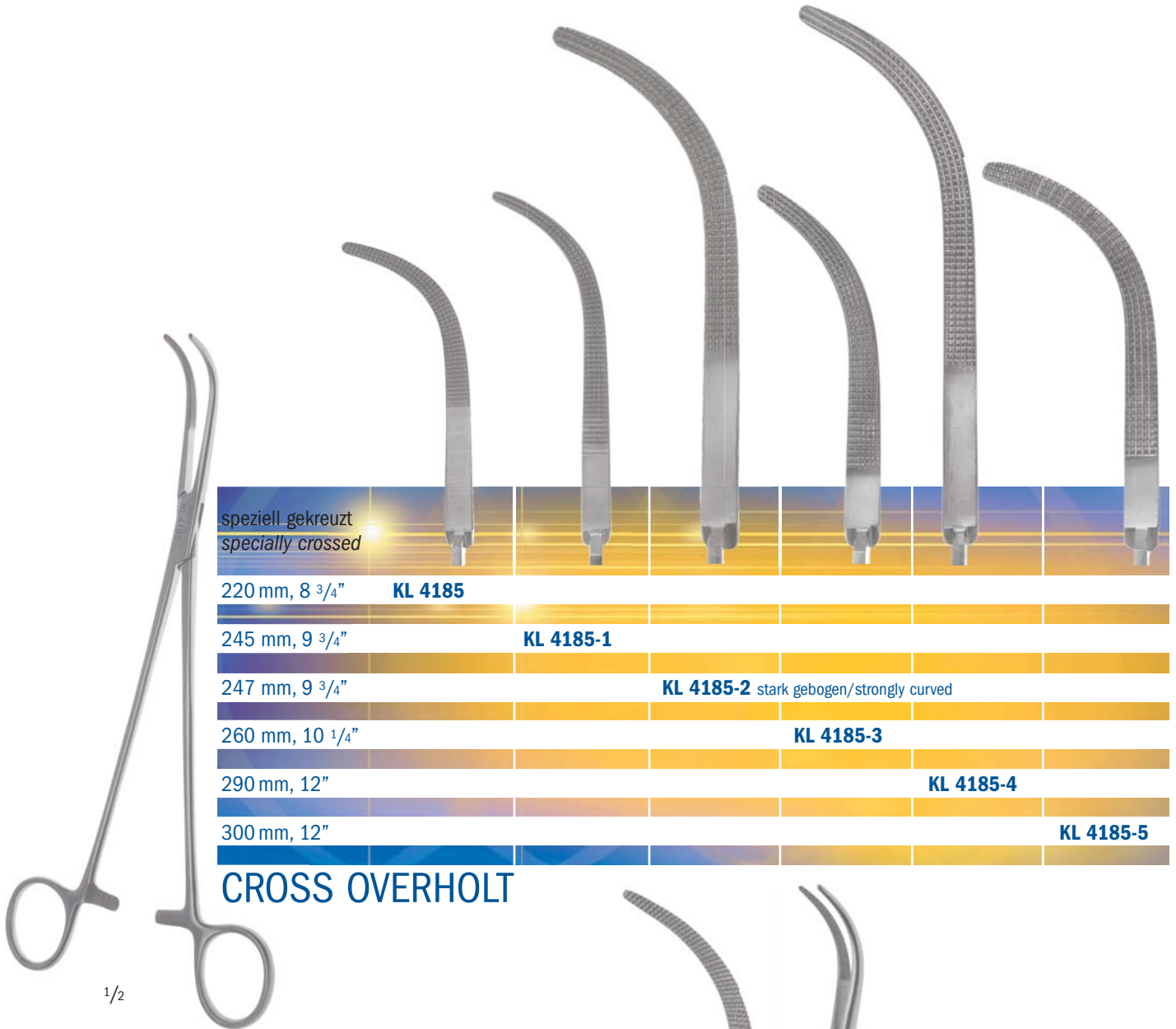

**CROSS OVERHOLT**

1/2

kreuzgerieft in Karoformat  
cross serrated for suture fixation

210 mm, 8 1/4" **KL 4188**

**OVERHOLT N. SUEMERMANN**



1/2



gebogen  
curved

Fig.1

1/1

Fig.2

295 mm, 12"

**GF 3689**

305 mm, 12"

**GF 3687**

**HARRINGTON**



1/1

gebogen  
curved

Zahn links  
tooth left

Zahn rechts  
tooth right

230 mm, 9"

**GF 3721**

**GF 3722**

**SAROT**



1/2



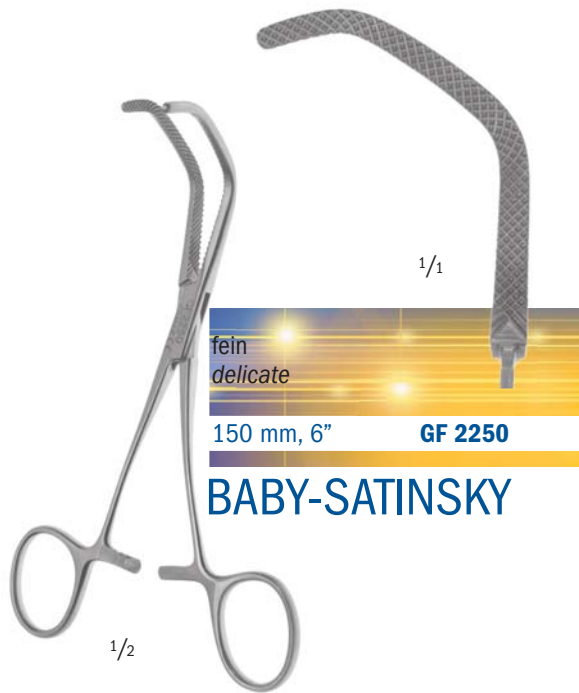

fein  
delicate  
150 mm, 6" **GF 2250**

**BABY-SATINSKY**

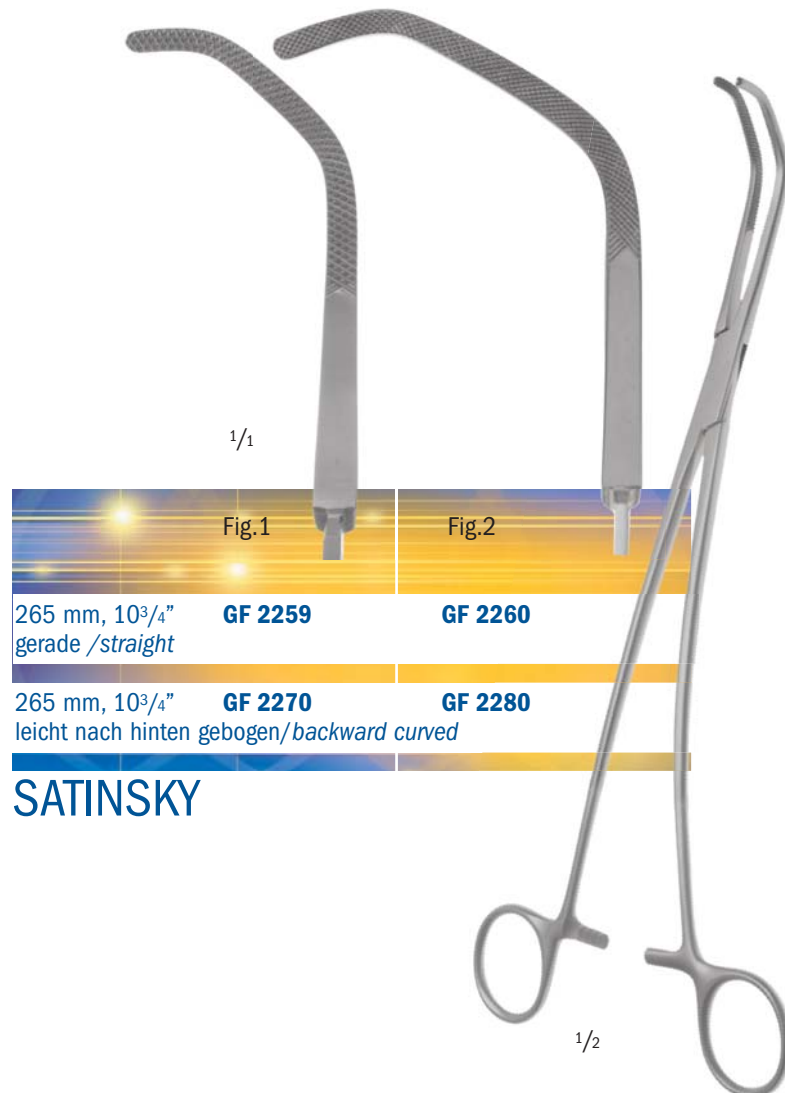

Fig.1	Fig.2
<b>GF 2259</b>	<b>GF 2260</b>
265 mm, 10 <sup>3</sup> / <sub>4</sub> " gerade /straight	
<b>GF 2270</b>	<b>GF 2280</b>
265 mm, 10 <sup>3</sup> / <sub>4</sub> " leicht nach hinten gebogen/backward curved	

**SATINSKY**





DE BAKEY Small Grip

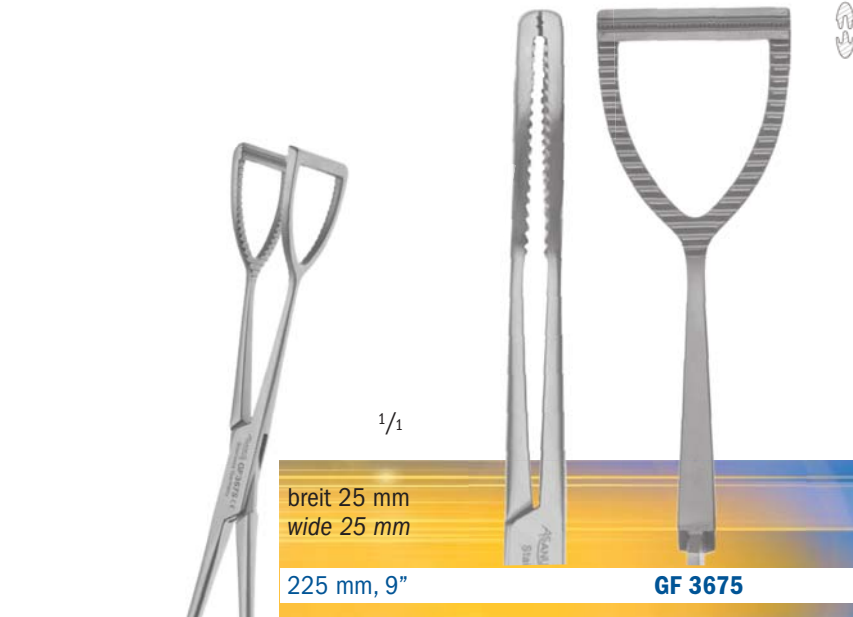

## DE BAKEY

DE BAKEY Standard distale Section mit speziellem, gefensterter Maulform, vorne geschlossen und am U-förmigen Maulteil mit Abstand versehen, das eine Verquetschung des Gewebes verhindert aber gleichzeitig sicherer Halt des Gewebes.

*DE BAKEY Standard distal section on specially shaped fenestrated jaws provide a soft but secure hold with minimal tissue damage.*



1/2

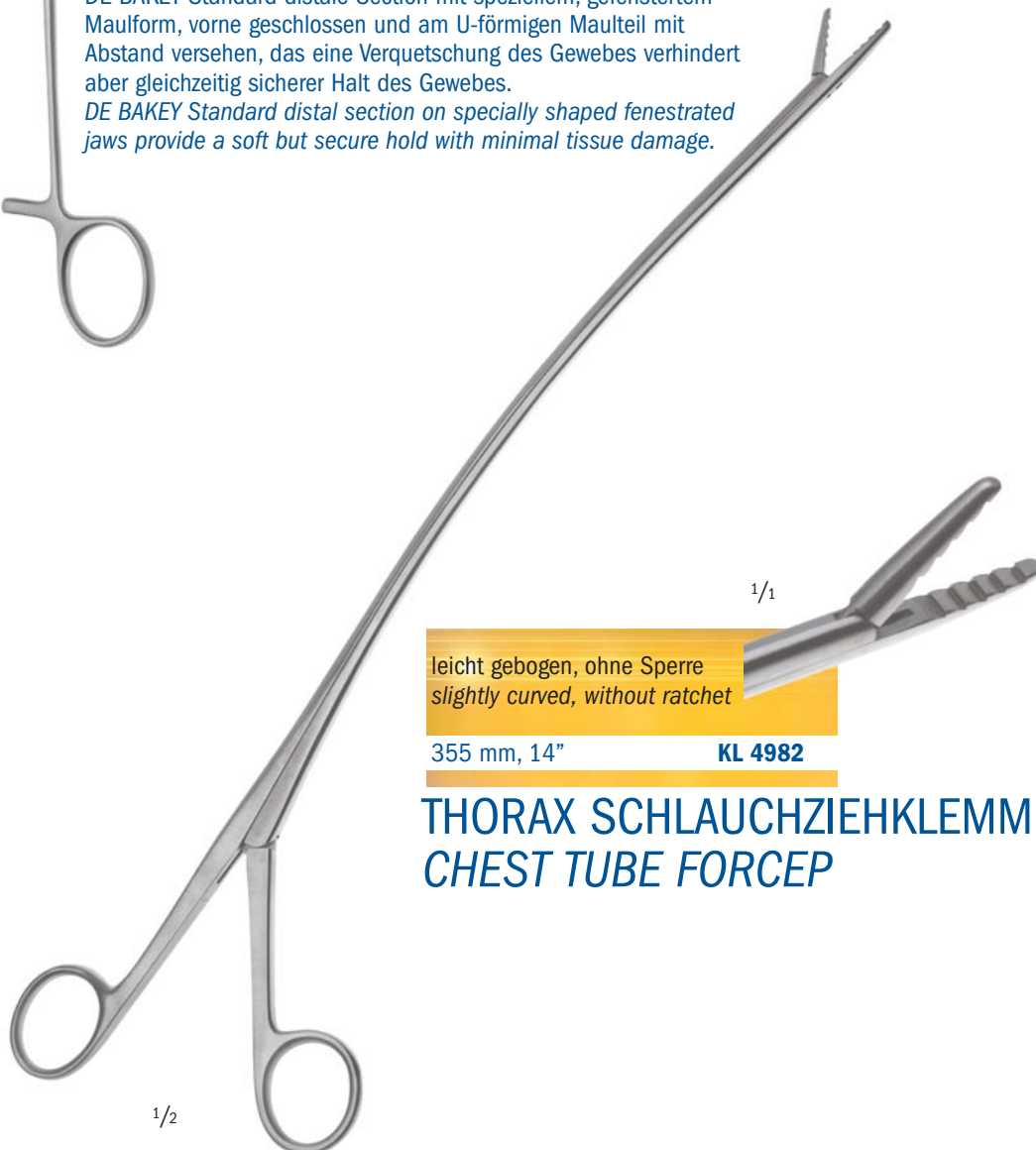

1/1

leicht gebogen, ohne Sperre  
*slightly curved, without ratchet*

355 mm, 14"

**KL 4982**

## THORAX SCHLAUCHZIEHKLEMMME CHEST TUBE FORCEP





	komplett mit Obturator <i>complete with obturator</i>	Nutzlänge <i>working length</i>	Trokarhülse allein <i>trocac sleeve only</i>	Obturator allein <i>obturator only</i>
Ø 6 mm	<b>TR 00800</b>	50 mm	<b>TR 00803</b>	<b>TR 00806</b>
Ø 11 mm	<b>TR 00801</b>	50 mm	<b>TR 00804</b>	<b>TR 00807</b>
Ø 13 mm	<b>TR 00802</b>	50 mm	<b>TR 00805</b>	<b>TR 00808</b>

**THORAX-TROKARE** starr  
**THORACIC TROCARS** rigid



	komplett mit Obturator <i>complete with obturator</i>	Nutzlänge <i>working length</i>	Trokarhülse allein <i>trocac sleeve only</i>	Obturator allein <i>obturator only</i>	flexible Kunststoff- rohre, Pack. a 5 St. <i>flexible silicon tubes 5 pcs/pack</i>
Ø 6 mm	<b>TR 00809</b>	100 mm	<b>TR 00813</b>	<b>TR 00817</b>	<b>TR 00821</b>
Ø 6 mm	<b>TR 00810</b>	70 mm	<b>TR 00814</b>	<b>TR 00818</b>	<b>TR 00822</b>
Ø 11 mm	<b>TR 00811</b>	100 mm	<b>TR 00815</b>	<b>TR 00819</b>	<b>TR 00823</b>
Ø 13 mm	<b>TR 00812</b>	70 mm	<b>TR 00816</b>	<b>TR 00820</b>	<b>TR 00824</b>

**THORAX-TROKARE** flexibel  
**THORACIC TROCARS** flexible

Wundspreizer, dicke Ausführung  
*Wound retractor, thick design*

165 mm, 6<sup>3</sup>/<sub>4</sub>" **WH 5370-1**

## MAYO-ADAMS

FÜR THORAX INDIKATION BEI DER  
MINIMAL INVASIVEN CHIRURGIE  
*FOR THORAX RETRACTION AT MIS*



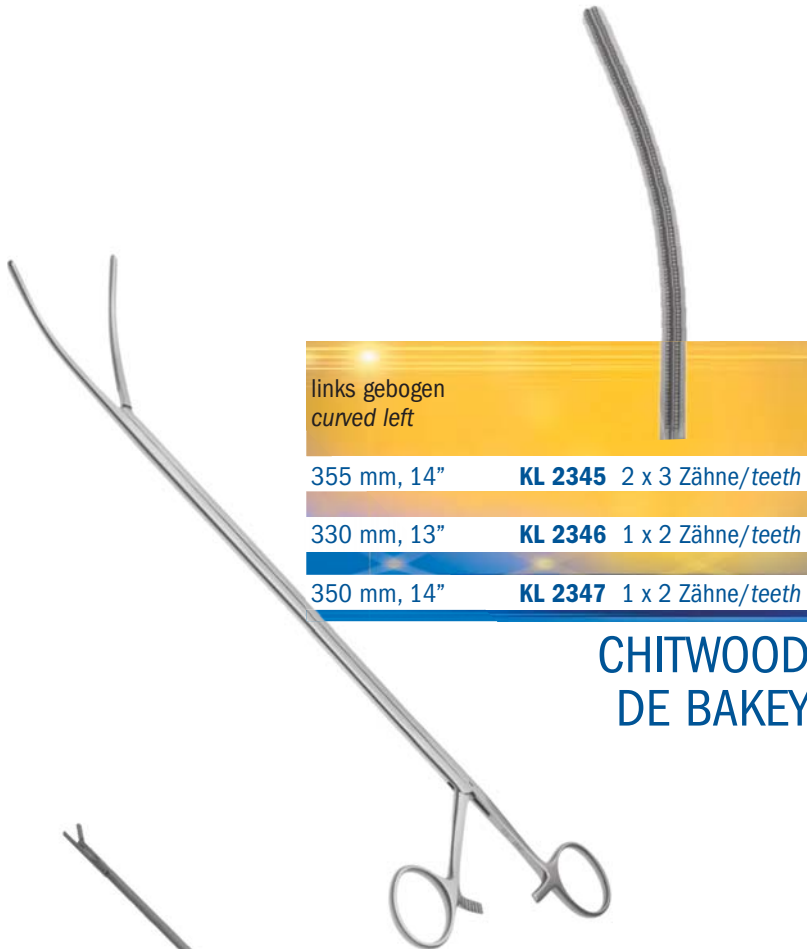

links gebogen  
curved left

355 mm, 14" **KL 2345** 2 x 3 Zähne/teeth

330 mm, 13" **KL 2346** 1 x 2 Zähne/teeth

350 mm, 14" **KL 2347** 1 x 2 Zähne/teeth

## CHITWOOD DE BAKY



Ø 5 mm  
Ø 5 mm

330 mm **EN 2501**

## ENDO-Nadelhalter ENDO-Needle Holder

Hartmetall, 30° Axialgriff mit Sperre,  
Spülanschluß, Supergrip Maulinlay  
Hard metal, 30° axial handle with ratchet,  
flushing port, Supergrip mouthpart



1/1

Ø 6 mm  
Ø 6 mm

440 mm, 18" **SG 0046**

## VIGANO

Gefäßsauger  
Vascular Suction Tube

1/2

Innovative ASANUS MIC Instrumente für Valvenchirurgie, Ultra-Leichtgewicht, perfekte Balance, TOP GRIP Griff und integriertem Spülgang.

*Innovative ASANUS MIC Instruments for valve surgery, ultra-lightweight, perfectly balanced, TOP GRIP handle and integrated cleaning channel.*



Scheren  
Scissors

**EN 7400** 15° gebogen/15° curved

**EN 7401** 30° gebogen/30° curved

**EN 7402** 70° gebogen/70° curved

**EN 7410** 45° Potts/45° Potts-style

**EN 7413** 125° Potts/125° Potts-style

Nadelhalter mit Sperre  
Needle holder with ratchet

**EN 7420** TC gerade/TC straight

**EN 7421** TC gebogen/TC curved

**EN 7422** TC Ryder/TC Ryder

**EN 7426** TC gebogen, fein 3mm/TC curved,  
mini jaw, fine 3 mm shaft

Standard Arbeitslänge 230 mm,  
für Arbeitslänge 170 mm fügen Sie ein "S" zur Artikelnummer,  
für Arbeitslänge 330 mm fügen Sie ein "L" zur Artikelnummer bei der Bestellung.  
*Standard working length 230 mm,  
for 170 mm working length add "S" behind article number,  
for 330 mm working length add "L" behind article number when ordering.*

	<p>DeBakey Faszangens          DeBakey Graspers</p>
	<p><b>EN 7430</b> 1x2 Zähne, schmal/          1x2 AG, small jaw</p>
	<p><b>EN 7431</b> 1x2 Zähne, schmal, aufgebogen/          1x2 AG, small jaw, angled upwards</p>
	<p><b>EN 7432</b> 1x2 Zähne, schmal, seitr. gebogen/          1x2 AG, small jaw, curved to side</p>
	<p><b>EN 7434</b> Resano/Resano jaw for valves</p>
	<p><b>EN 7435</b> 2x3 Zähne, breit/2x3 AG, wide jaw</p>
	<p>Knotenschieber          Knot Pusher</p>
	<p><b>EN 7440</b> 15° gebogen/15° curved</p>

Standard Arbeitslänge 230 mm,  
 für Arbeitslänge 170 mm fügen Sie ein "S" zur Artikelnummer,  
 für Arbeitslänge 330 mm fügen Sie ein "L" zur Artikelnummr bei der Bestellung.  
 Standard working length 230 mm,  
 for 170 mm working length add "S" behind article number,  
 for 330 mm working length add "L" behind article number when ordering.



**GF 3121**

Valvensperrer für die MINI Thoracotomy mit geraden Armen, 30 x 60 mm Blätter und beweglichem Bügel  
*Valve retractor for MINI thoracotomy with straight arms, 30 x 60 mm blades and turnable crossbar detachable*

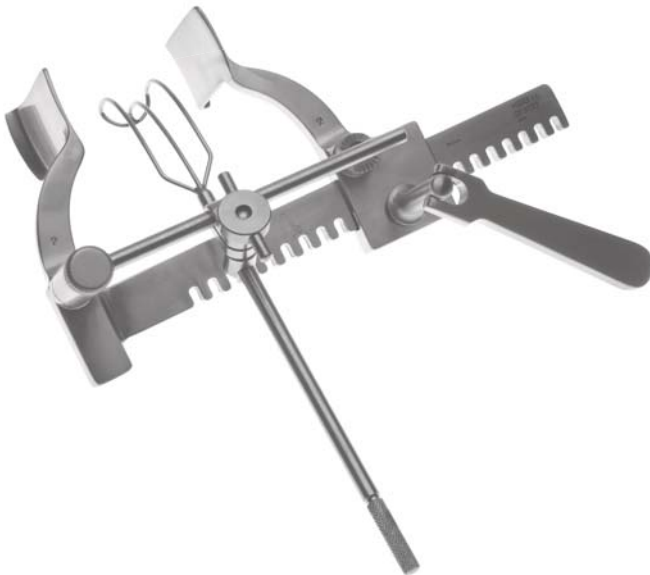

**GF 3122**

Valvensperrer für die MINI Thoracotomy mit kräftigen Armen, 30 x 60 mm Blätter und beweglichem Bügel  
*Valve retractor for MINI thoracotomy with strong arms, 30 x 60 mm blades and turnable crossbar detachable*



**GF 3123**

Valvensperrer für die MINI Thoracotomy mit beweglichen Armen, 2x 30 x 40 mm und 30 x 60 mm Blätter und beweglichem Bügel  
*Valve retractor for MINI thoracotomy with hinged arms, each 2x 30 x 40 mm and 30 x 60 mm blades and turnable crossbar detachable*



<b>Gefäß Dilatatoren</b> <b>Vascular Dilators</b>	1,0 mm Kopf-Ø Head-Ø	1,5 mm Kopf-Ø Head-Ø	2,0 mm Kopf-Ø Head-Ø	2,5 mm Kopf-Ø Head-Ø	3,0 mm Kopf-Ø Head-Ø	3,5 mm Kopf-Ø Head-Ø	4,0 mm Kopf-Ø Head-Ø	4,5 mm Kopf-Ø Head-Ø	5,0 mm Kopf-Ø Head-Ø
140 mm 5½"	<b>GF 0241</b>	<b>GF 0242</b>	<b>GF 0243</b>	<b>GF 0244</b>	<b>GF 0245</b>	<b>GF 0246</b>	<b>GF 0247</b>	<b>GF 0248</b>	<b>GF 0249</b>

## GARRET VASCULAR DILATORS

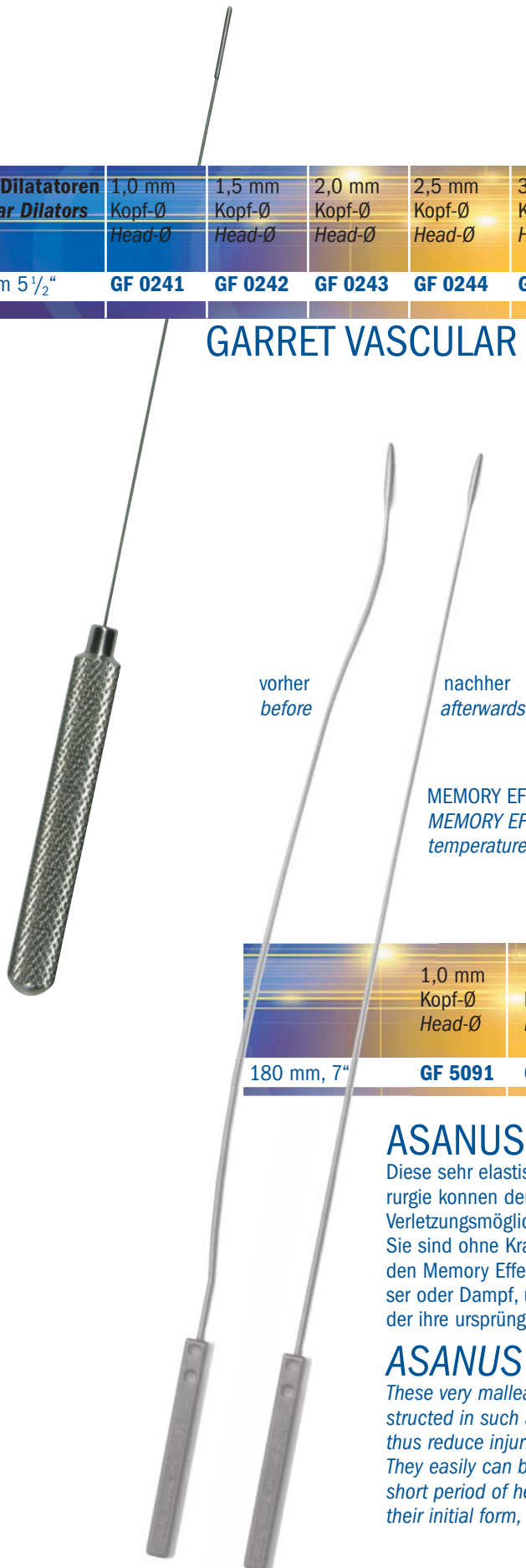

vorher  
before

nachher  
afterwards

MEMORY EFFECT nach dem Wasch- und Desinfektionsprozeß  
MEMORY EFFECT after washing and disinfection process via temperature

	1,0 mm Kopf-Ø Head-Ø	1,25 mm Kopf-Ø Head-Ø	1,75 mm Kopf-Ø Head-Ø	2,0 mm Kopf-Ø Head-Ø	3,0 mm Kopf-Ø Head-Ø
180 mm, 7"	<b>GF 5091</b>	<b>GF 5091-1</b>	<b>GF 5091-3</b>	<b>GF 5092</b>	<b>GF 5093</b>

## ASANUS Nitinol Gefäßsonden

Diese sehr elastischen Sonden bzw. Dilatatoren für die Gefäßchirurgie können den Gefäßen extrem gut folgen und reduzieren die Verletzungsmöglichkeiten.

Sie sind ohne Kraftaufwand beliebig zu formen und nehmen durch den Memory Effekt nach einer kurzen Wärmebehandlung im Wasser oder Dampf, und auch während der Reinigungsprozesses, wieder ihre ursprüngliche Form an.

## ASANUS Nitinol Vessel Probes

These very malleable probes/dilators for vascular surgery are constructed in such a way that they can follow the vessel easily and thus reduce injuries.

They easily can be bent and due to their memory effect, after a short period of heat treatment in water or steam, they recover their initial form, even during the cleaning process.



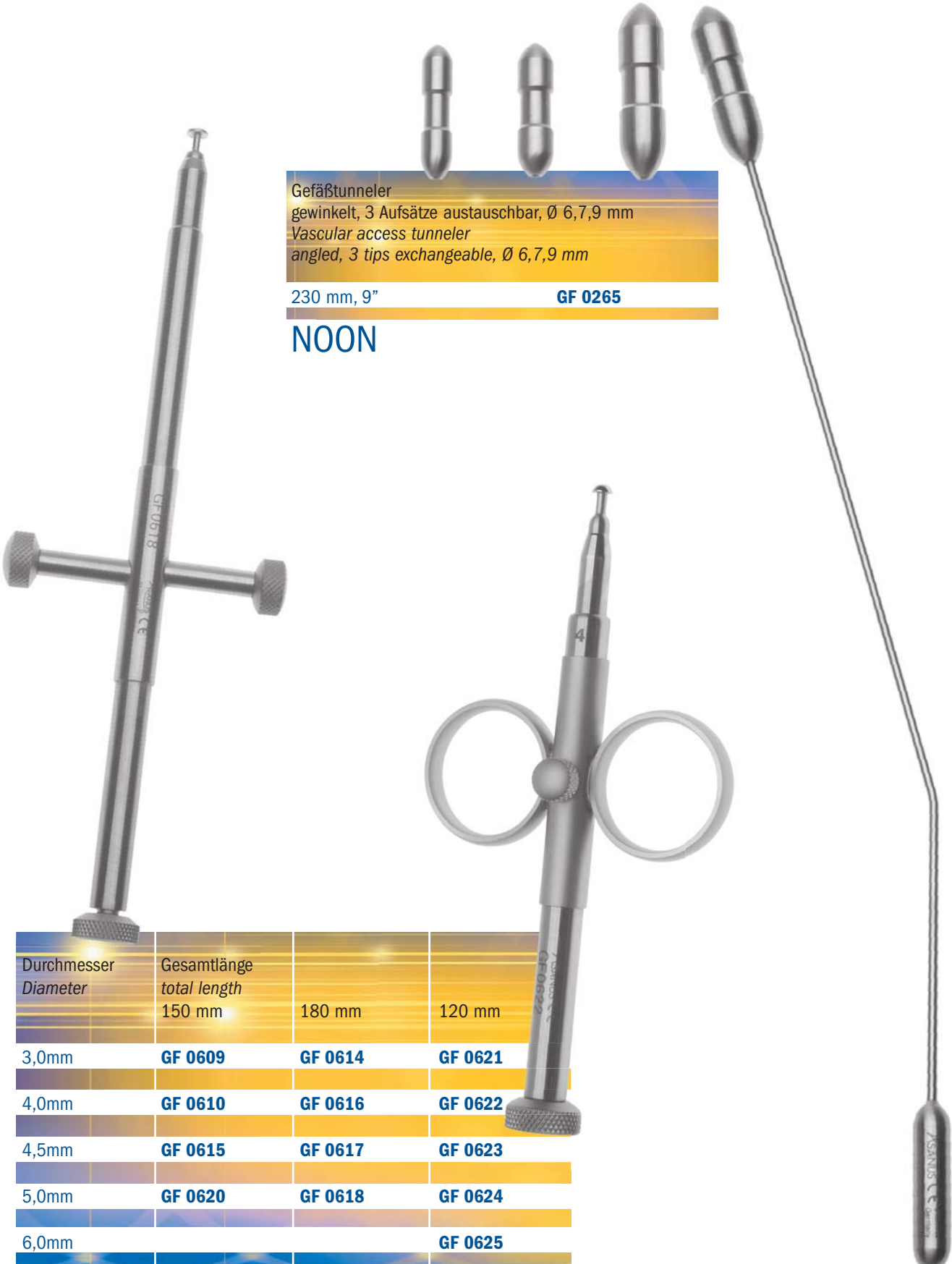

Gefäßstunneler  
 gewinkelt, 3 Aufsätze austauschbar, Ø 6,7,9 mm  
*Vascular access tunneler*  
 angled, 3 tips exchangeable, Ø 6,7,9 mm

230 mm, 9" **GF 0265**

**NOON**

Durchmesser <i>Diameter</i>	Gesamtlänge <i>total length</i>	150 mm	180 mm	120 mm
3,0mm	<b>GF 0609</b>	<b>GF 0614</b>	<b>GF 0621</b>	
4,0mm	<b>GF 0610</b>	<b>GF 0616</b>	<b>GF 0622</b>	
4,5mm	<b>GF 0615</b>	<b>GF 0617</b>	<b>GF 0623</b>	
5,0mm	<b>GF 0620</b>	<b>GF 0618</b>	<b>GF 0624</b>	
6,0mm			<b>GF 0625</b>	

**AORTA STANZEN DOUBLE CUTTER**

wiederverwendbare Stanzen, extra scharf /  
*reusable Punches, extra sharp*

Luer-Lock gerade / straight	Aussendurchmesser Kanüle / Outer diameter canula			
	Ø 1,2 mm	Ø 1,5 mm	Ø 2,0 mm	Ø 0,8 mm
60 mm	<b>SP 0500</b>	<b>SP 0504</b>	<b>SP 0508</b>	
80 mm		<b>SP 0512</b>	<b>SP 0518</b>	
115 mm		<b>SP 0520</b>		<b>SP 0516</b>
125 mm		<b>SP 0524</b>		

**KANÜLEN  
CANULAS**

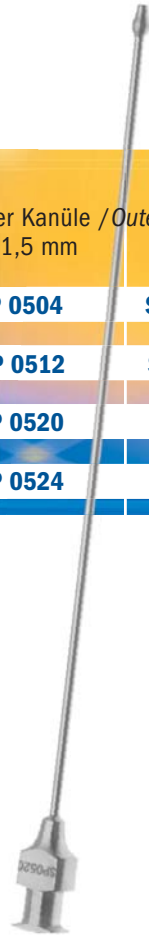

Luer-Lock gebogen / curved	Aussendurchmesser Kanüle / Outer diameter canula		
	Ø 1,2 mm	Ø 1,5 mm	Ø 2,0 mm
60 mm	<b>SP 0501</b>	<b>SP 0505</b>	<b>SP 0509</b>
80 mm	<b>SP 0511</b>	<b>SP 0513</b>	<b>SP 0515</b>
115 mm		<b>SP 0519</b>	

**KANÜLEN  
CANULAS**



Luer-Lock Nutzlänge/ useable length	Durchmesser / diameter				
	Ø 1,5 mm	Ø 2,0 mm	Ø 2,5 mm	Ø 3,5 mm	Ø 4,5 mm
130 mm	<b>MN 0740</b>	<b>MN 0810</b>	<b>MN 0880</b>	<b>MN 0950</b>	
150 mm	<b>MN 0760</b>	<b>MN 0830</b>	<b>MN 0900</b>	<b>MN 0960</b>	
180 mm	<b>MN 0780</b>	<b>MN 0850</b>	<b>MN 0920</b>	<b>MN 0970</b>	<b>MN 2300</b>
220 mm	<b>MN 0800</b>	<b>MN 0860</b>	<b>MN 0940</b>	<b>MN 0980</b>	

**YASARGIL**

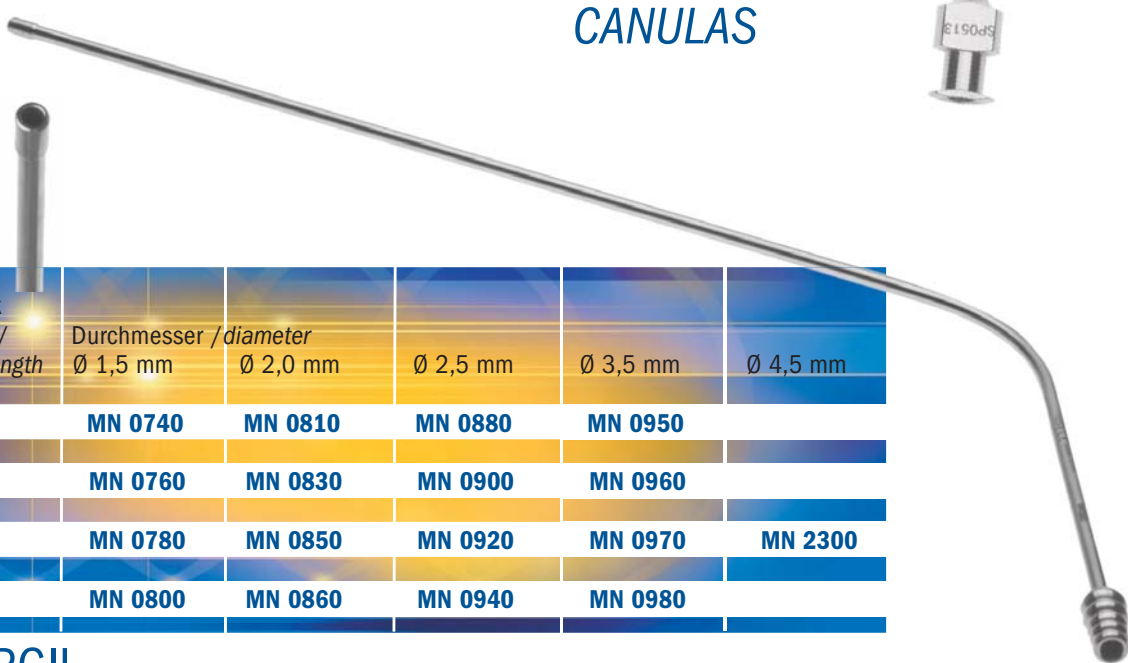

gebogen, 240 mm, 9 1/2"  
curved, 240 mm, 9 1/2"

Ø 4,2 mm **SG 0009**

Ø 6,0 mm **SG 0010**

Ø 6,0 mm **SG 0012** stark gebogen/strongly curved

Ø 6,3 mm **SG 0013** abschraubbaren Saugaufsatz/  
with removable sucker part

ANDREWS-  
PYCHON



Saugrohr Ø 8 mm  
suction tube Ø 8 mm

330 mm, 13" **SG 0048**

COOLEY

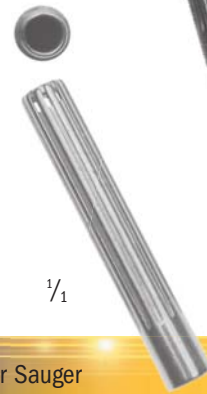

1/1

Vascular Sauger  
vascular Sucker

335 mm, 13" **SG 0049**

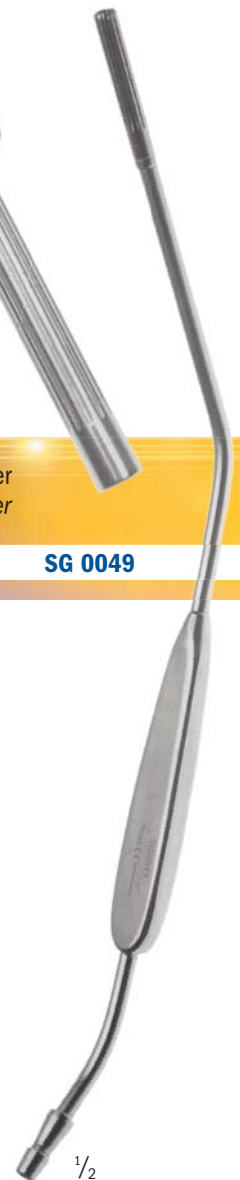

1/2

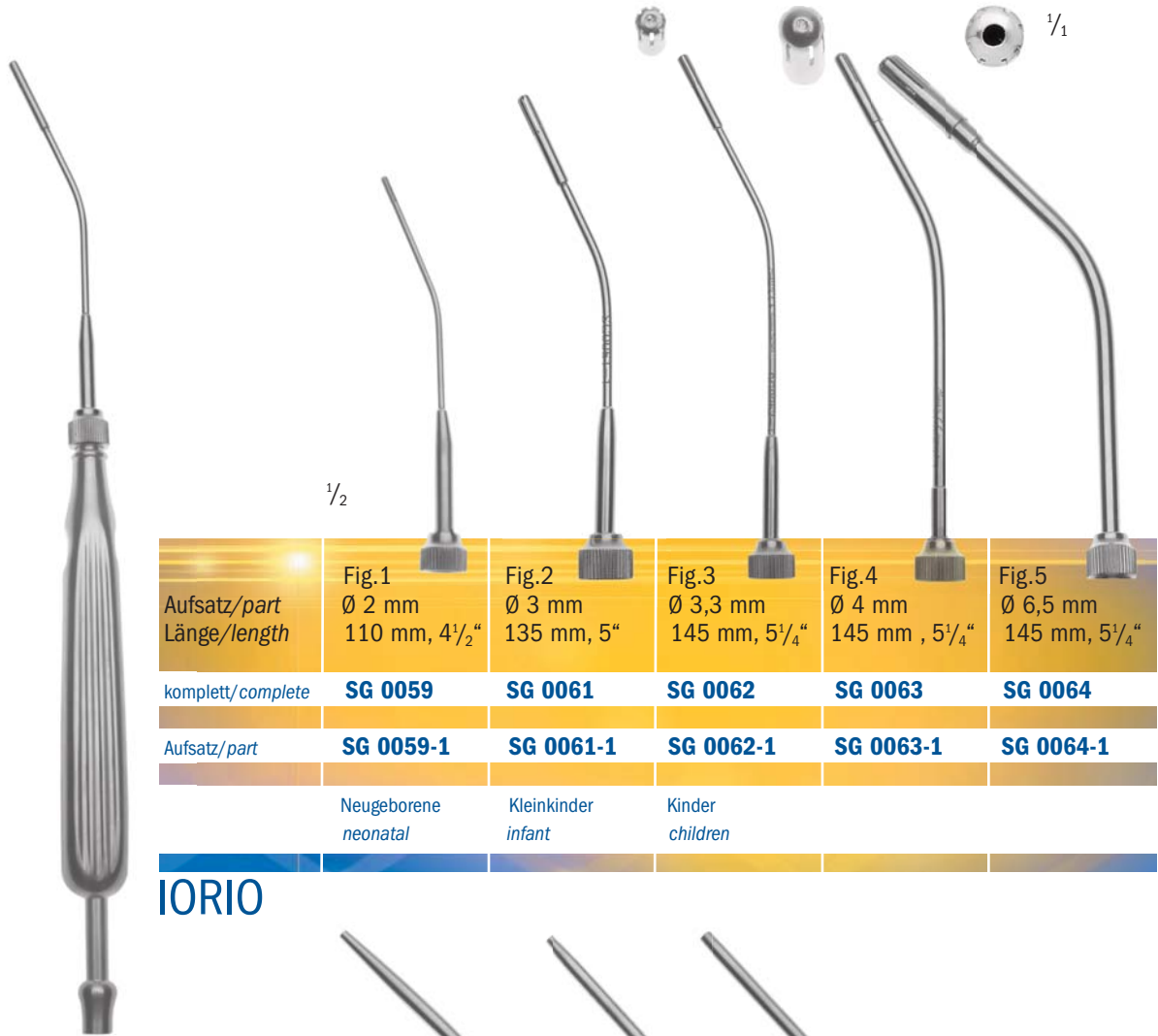
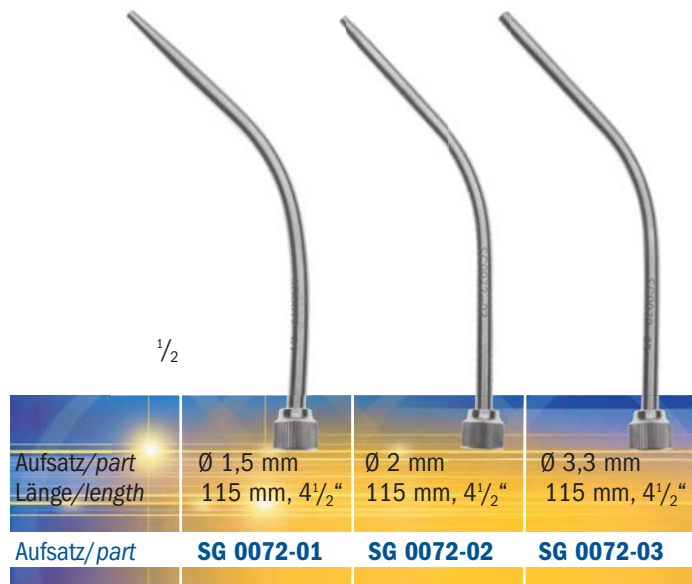

	Fig.1	Fig.2	Fig.3	Fig.4	Fig.5
Aufsatz/part Länge/length	Ø 2 mm 110 mm, 4 1/2"	Ø 3 mm 135 mm, 5"	Ø 3,3 mm 145 mm, 5 1/4"	Ø 4 mm 145 mm, 5 1/4"	Ø 6,5 mm 145 mm, 5 1/4"
komplett/complete	<b>SG 0059</b>	<b>SG 0061</b>	<b>SG 0062</b>	<b>SG 0063</b>	<b>SG 0064</b>
Aufsatz/part	<b>SG 0059-1</b>	<b>SG 0061-1</b>	<b>SG 0062-1</b>	<b>SG 0063-1</b>	<b>SG 0064-1</b>
	Neugeborene neonatal	Kleinkinder infant	Kinder children		

**IORIO**



	Ø 1,5 mm	Ø 2 mm	Ø 3,3 mm
Aufsatz/part Länge/length	115 mm, 4 1/2"	115 mm, 4 1/2"	115 mm, 4 1/2"
Aufsatz/part	<b>SG 0072-01</b>	<b>SG 0072-02</b>	<b>SG 0072-03</b>

Saugeraufsatz Mikro, für Griff SG 0055  
Frontal sucker part, for handle SG 0055



Griff allein  
handle alone

**SG 0055**

**IORIO**



Saugrohr, innen Ø 3 mm  
suction tube, inner Ø 3 mm

285 mm, 11" **SG 0011**

**RÜHLAND**

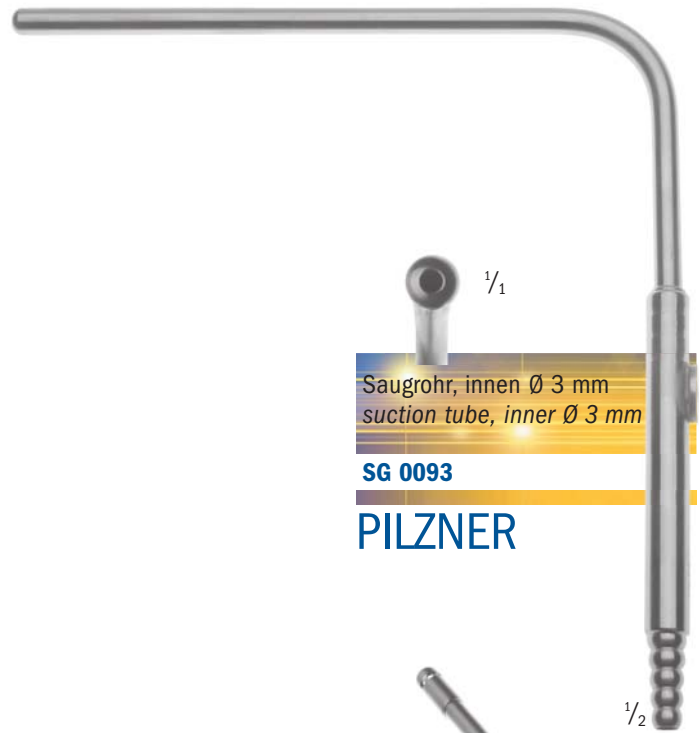

Saugrohr, innen Ø 3 mm  
suction tube, inner Ø 3 mm

**SG 0093**

**PILZNER**



Saugrohr, Ø 6 mm  
suction tube, Ø 6mm

300 mm, 12" **SG 4060**

**COOLEY**

Sauger  
suction tube

**SG 0005**

1/1



275 mm, 10 1/2" **SG 0840**

**YANKAUER**



1/2

1/1

Ø 9 mm  
Ø 9 mm

275 mm, 10 1/2" **SG 0850**

**DE BAKEY**



1/2

1/1

Ø 10 mm  
Ø 10 mm

270 mm, 10 1/2" **HA 2070**

**YANKAUER**



1/2

1/1

Ø 6 mm  
Ø 6 mm

440 mm, 18" **SG 0046**

**VIGANO**



1/2



sehr fein  
delicate

165 mm, 6 1/2" **GF 0409**

**"SALZBURGER" SPATEL**  
für Carotis und feine Gefäße  
for carotid and delicate vessels

<b>Dissektor</b> <b>dissector</b> tip 1 mm	stumpf blunt	scharf sharp
250 mm, 10" <b>GF 4901</b>	<b>GF 4902</b>	

**MICRO-DISSECTOR**



<b>Titan Griff</b> <b>Titanium handle</b>	Arbeitslänge working length	MICRO 2 mm	3 mm
220 mm, 8 3/4" bajonett/bajonette shape	95 mm	<b>GF 8905</b>	<b>GF 8907</b>
220 mm, 8 3/4" bajonett/bajonette shape	115 mm		<b>GF 8908</b>
220 mm, 8 3/4" gerade/straight	115 mm		<b>GF 8900</b>

**DISSECTOR**

Arbeitslänge  
working length



für Nahtfixation  
for suture-fixation  
220 mm, 8 3/4" **MN 1828**



209 mm, 8 1/4"	<b>GF 2351</b>	Ø 0,8 m	Ø 1,2 mm
250 mm, 10"	<b>GF 2354</b>	<b>GF 2356</b>	<b>GF 2357</b>

**PÄIVI**



flexibel, Ø 4,0mm  
 flexible, Ø 4,0mm

320 mm, 13" **GF 2350**

## RUMEL-BELMONT



1/2

Mandrin allein  
 guide only

1/1

klein  
 small

groß  
 big

220 mm, 8 3/4"

**GF 2360**

**GF 2370**

## STRIPPER

1/2

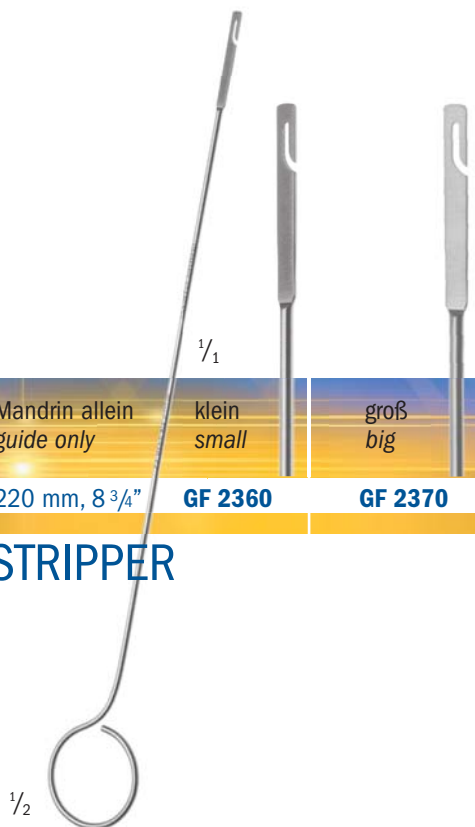

GF 6041

GF 6042

leicht gebogen  
 slightly curved

Durchziehröhr mit Olive, 650 mm **GF 6040**  
 tunneler tube with olive, 650 mm

Bulldog-Mandrin, 730 mm **GF 6041**  
 Bulldog-Mandrin, 730 mm

Aufsatz **GF 6042**  
 upper part

## TUNNELIERUNGSINSTRUMENT TUNNELER INSTRUMENT

GF 6040

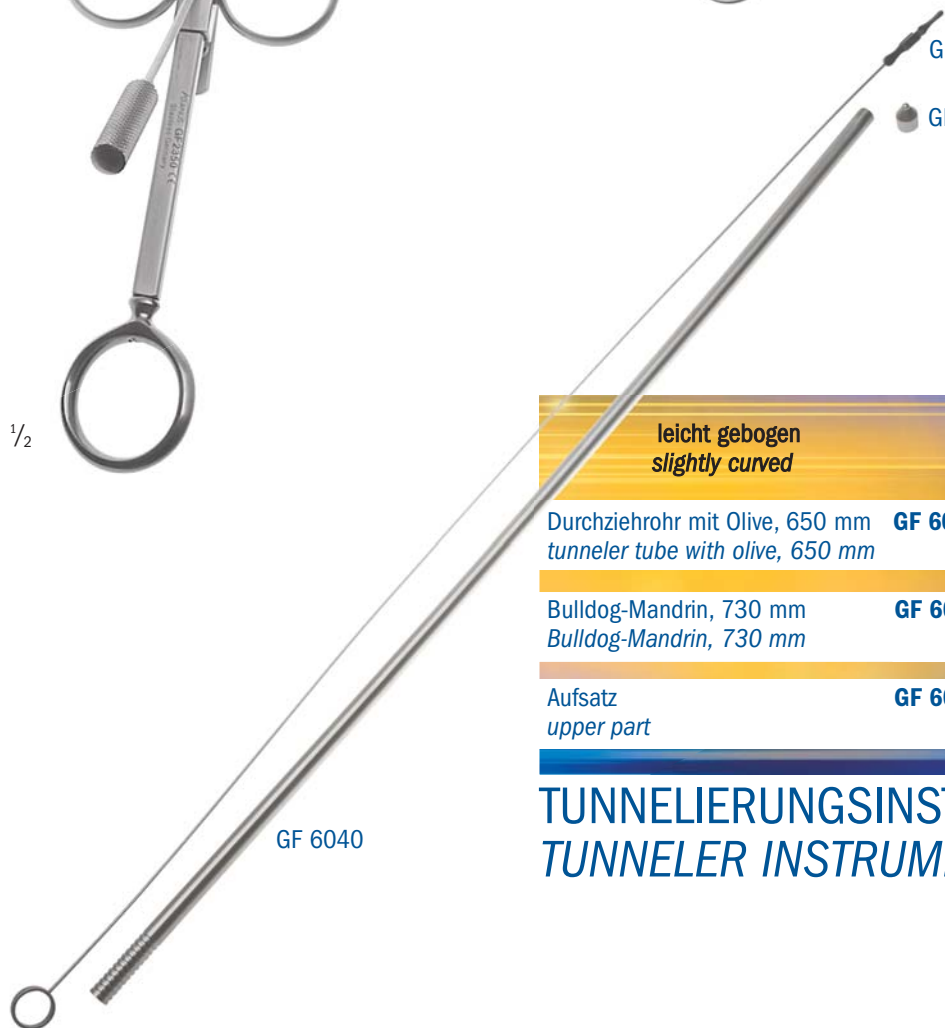

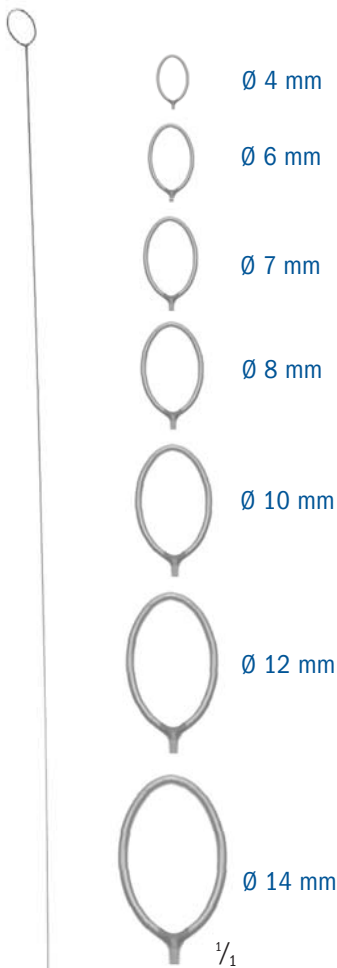

550 mm, 22"  
oval, oval

Ø 4 mm **GF 0270**

Ø 6 mm **GF 0271**

Ø 7 mm **GF 0272**

Ø 8 mm **GF 0273**

Ø 10 mm **GF 0274**

Ø 12 mm **GF 0275**

Ø 14 mm **GF 0276**

**RING STRIPPER**  
**RING STRIPPER**

Griff für Ring Stripper  
handle for ring stripper

**GF 0277**

$\frac{1}{2}$

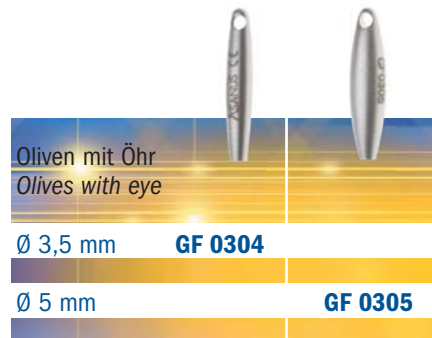

**GF 0300** Set Kombi-PinStripper für invertierter Venenstripping  
bestehend aus:  
Set Combi-PinStripper for inverted vein stripping  
consisting of:

**GF 0301** PinStripper kurz 340 mm lang  
PinStripper short 340 mm long

**GF 0302** PinStripper mittel 490 mm lang  
PinStripper short 490 mm long

**GF 0303** PinStripper lang 590 mm lang  
PinStripper short 590 mm long

**GF 0304** Ø 3,5 mm, kleine Olive mit Ohr und Gewindeansatz passend  
für PinStripper GF 0301, GF 0302, GF 0303  
Ø 3,5 mm, little olive with eye and thread fitting  
to PinStripper GF 0301, GF 0302, GF 0303

**GF 0305** Ø 5 mm, mittlere Olive mit Ohr und Gewindeansatz passend  
für PinStripper GF 0301, GF 0302, GF 0303  
Ø 5 mm, medium olive with eye and thread fitting  
to PinStripper GF 0301, GF 0302, GF 0303

**GF 0112** Kunststoffsondenspitze  
plastic probes tip

**GF 0114** Metallsondenspitze  
metal probes tip

**GF 0115** Olive 6 mm  
olive 6 mm

**GF 0116** Olive 9 mm  
olive 9 mm

**GF 0117** Olive 12 mm  
olive 12 mm

**GF 0118** Olive 15 mm  
olive 15 mm

**ND 0852** gelochte Dose für Olivenlagerung  
perforated case for olives

**HOFFMANN**

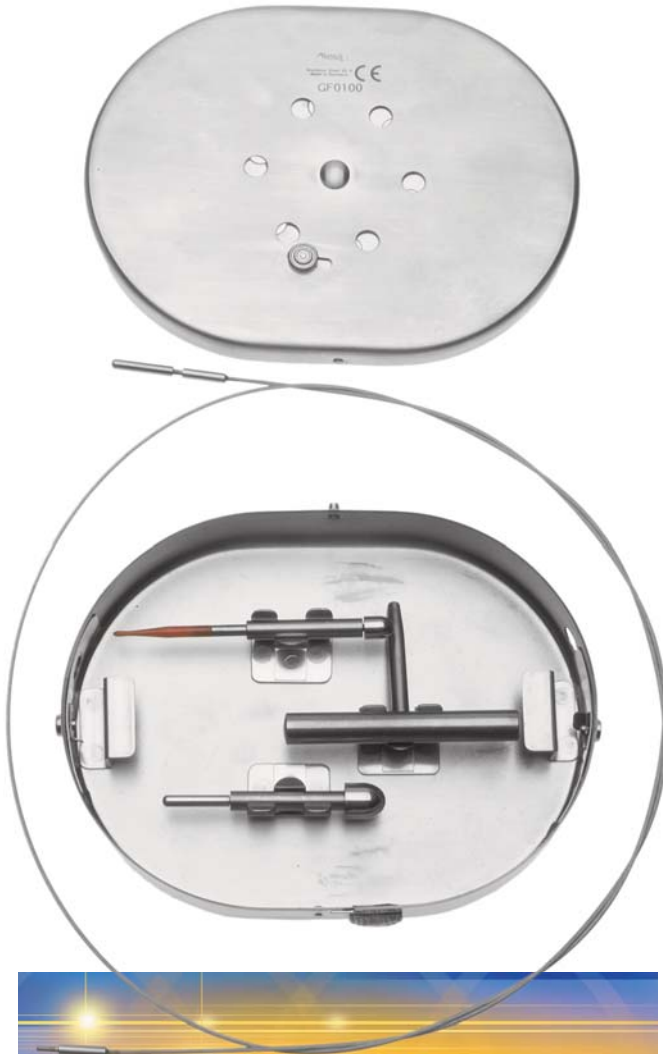

135 x 100 x 25 mm, komplett/complete **GF 0100**

## NABATOFF

bestehend aus Kunststoffhülse, Zugseil und Metalloliven  
*consisting of plastic tip, cable flexible and metal olives*



Oliven alleine <i>Olives only</i>	Ø 6 mm	Ø 9 mm	Ø 12 mm	Ø 15 mm
--------------------------------------	--------	--------	---------	---------

<b>GF 0115</b>	<b>GF 0116</b>	<b>GF 0117</b>	<b>GF 0118</b>
----------------	----------------	----------------	----------------

Handgriff  
*handle*



**GF 0190**

Zugseil biegsam  
*cable malleable*

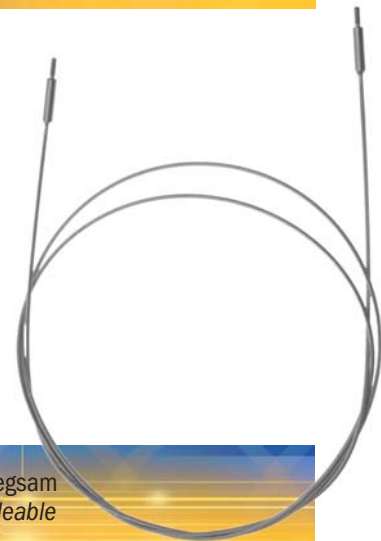

900 mm, Ø 1,3 mm

**GF 0111**

900 mm, Ø 2,5 mm

**GF 0119**

Filiformspitze, fein  
*Filiform tip, delicate*



**GF 0112**

Metallsondenspitze  
*Metal probe*



Ø 3 mm

**GF 0114**

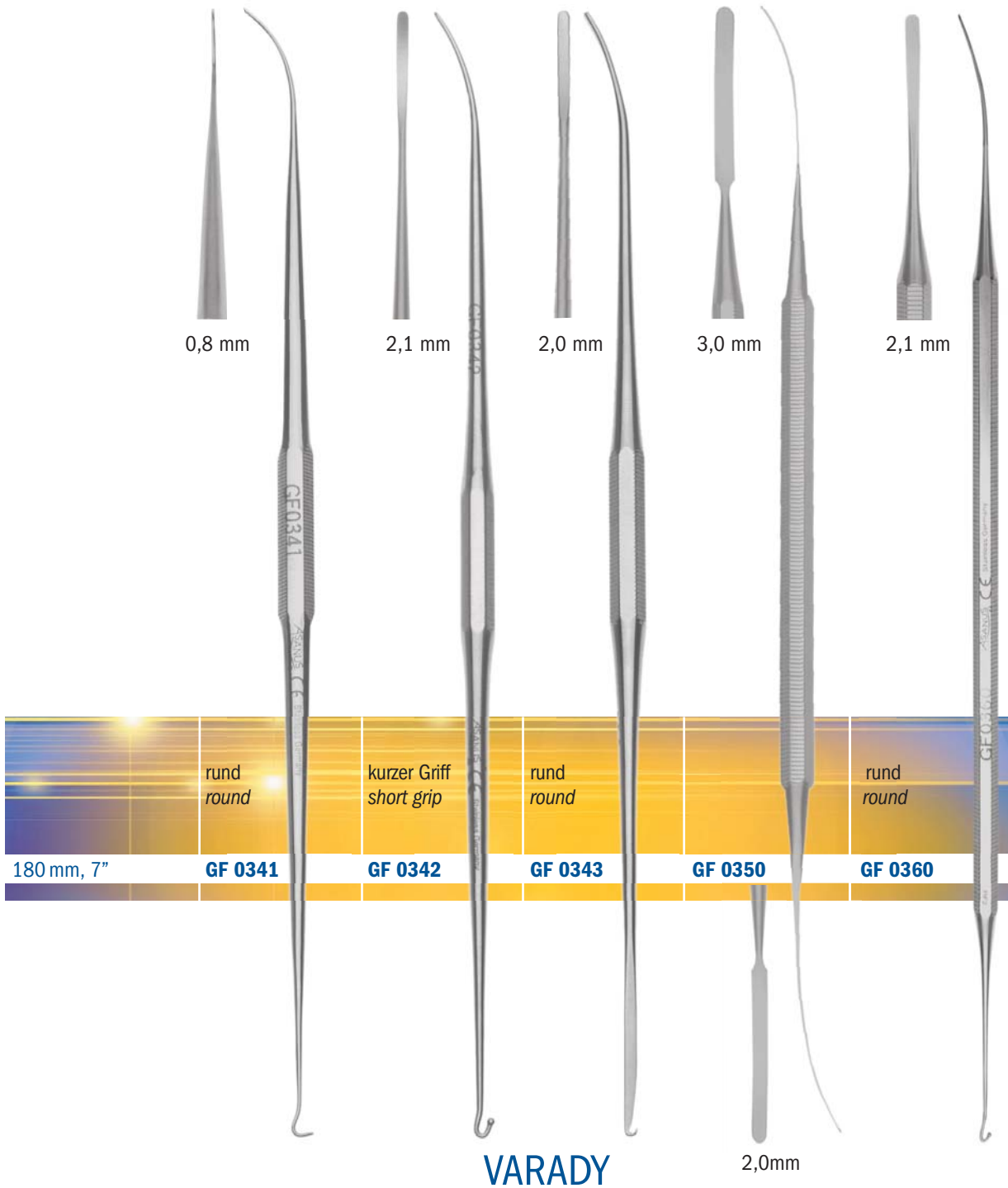

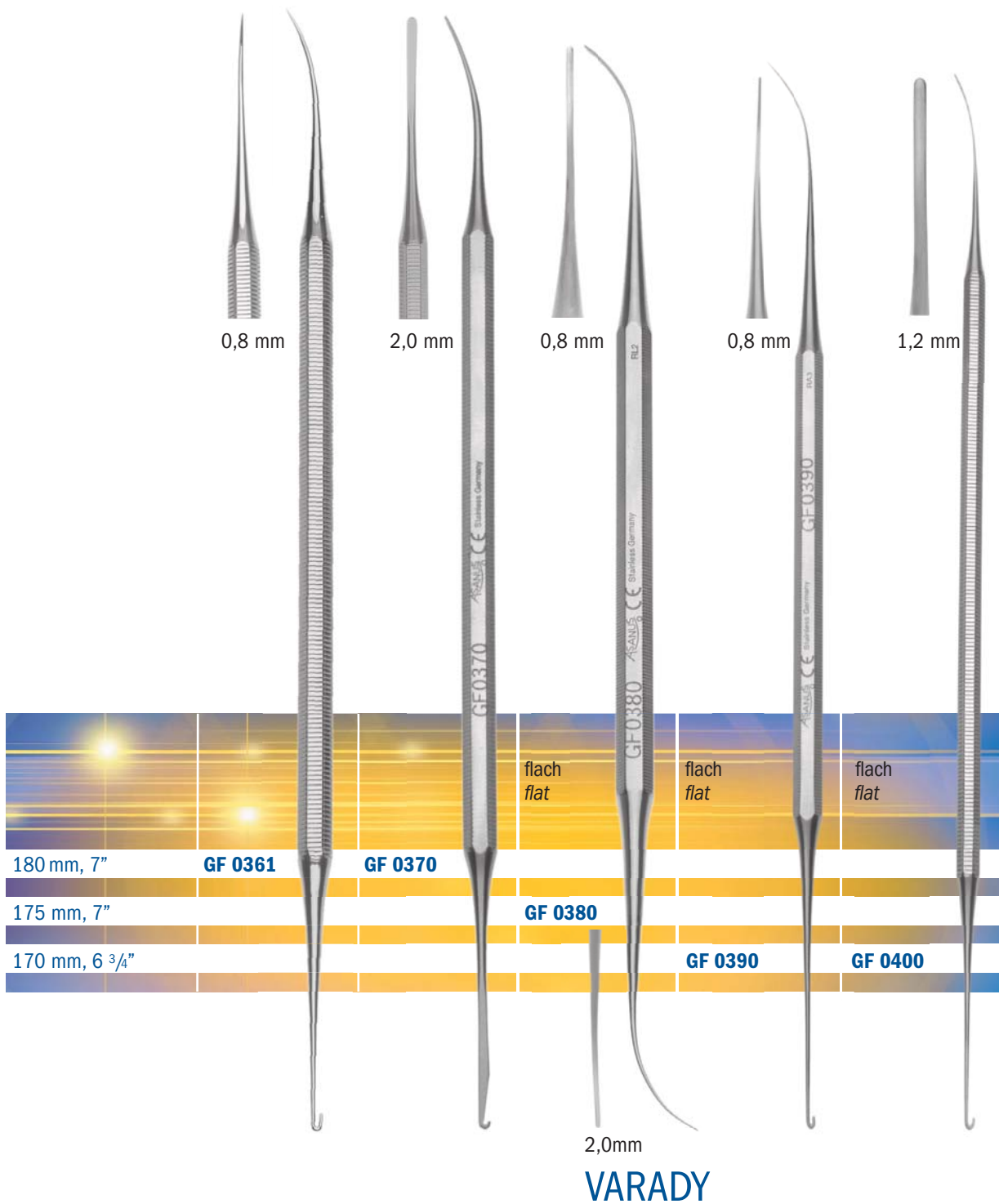

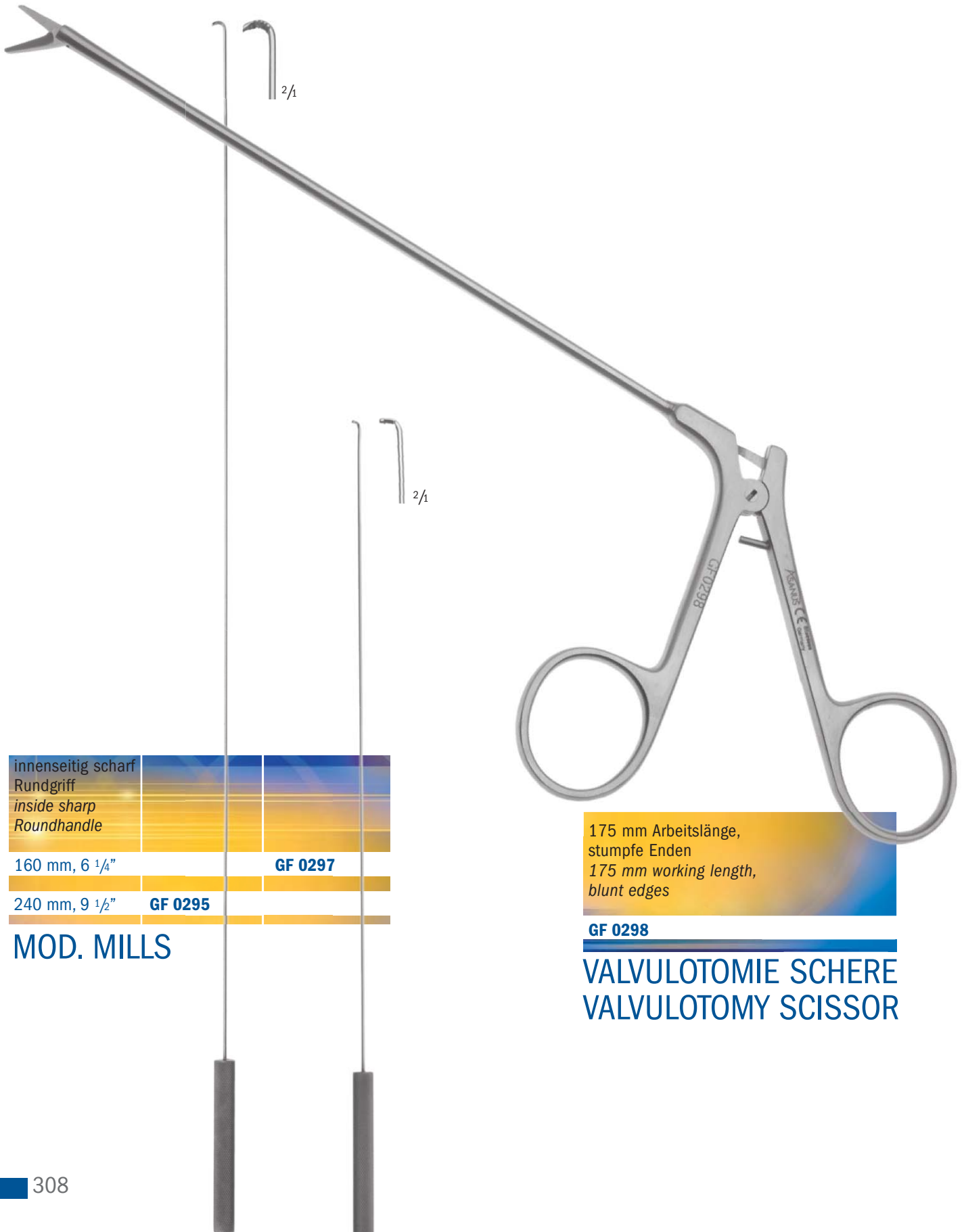

innenseitig scharf  
Rundgriff  
inside sharp  
Roundhandle

160 mm, 6 1/4"

**GF 0297**

240 mm, 9 1/2"

**GF 0295**

**MOD. MILLS**

175 mm Arbeitslänge,  
stumpfe Enden  
175 mm working length,  
blunt edges

**GF 0298**

**VALVULOTOMIE SCHERE  
VALVULOTOMY SCISSOR**



halbscharf  
*semisharp*

80 mm, 3<sup>1</sup>/<sub>3</sub>"

**WH 5018**

120 mm, 4<sup>3</sup>/<sub>4</sub>"

**WH 5019**

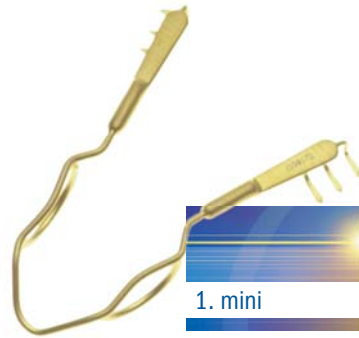

1. mini

**WH 5044**



2. standard

**WH 5045**



stumpf  
*blunt*

80 mm, 3<sup>1</sup>/<sub>3</sub>"

**WH 5018-1**

120 mm, 4<sup>3</sup>/<sub>4</sub>"

**WH 5019-1**

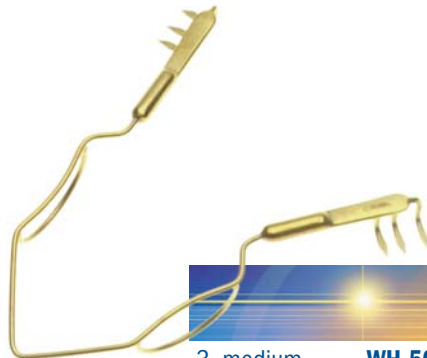

3. medium

**WH 5046**

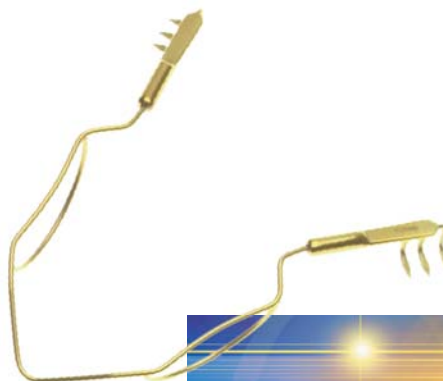

4. maxi

**WH 5047**

**KARMODY RETRACTOR**

**I.M.A.  
 EPICARTEUR**





Ø 0,5 mm	<b>SG 0029</b>
Ø 0,8 mm	<b>SG 0030</b>
Ø 1,0 mm	<b>SG 0031</b>
Ø 1,2 mm	<b>SG 0032</b>
Set	<b>SG 0034</b>
bestehend aus je 1 Stk SG 0030, SG 0031, SG 0032 <i>consisting of one piece each          SG 0030, SG 0031, SG 0032</i>	

## HEPARIN KANÜLE HEPARIN CANULA



Durch den Safety Schutzmechanismus können Sie sicher im Schnittfeld arbeiten und sich davon wieder entfernen.  
*Due to the simple safety mechanism you may work sure in the cutting field and remove in an optimal way the knife again.*

	 45°	 60°	 30°
Diamantmesser <i>komplett</i> / <i>diamond knife complete</i>	<b>GF 5080</b>	<b>GF 5078</b>	<b>GF 5077</b>
Klinge und Griff / <i>blade and handle, Länge / length 200 mm</i>			<b>GF 5076</b>

## DIAMANTMESSER DIAMOND KNIFE

sind das weltweit härteste Material mit bestem Mikroschnitt.  
*have the hardest cutting edge with excellent cutting result in micro surgery.*



Blattstärke 0,15 - 0,2 mm <i>blade strongness 0,15 - 0,2 mm</i>	 30°
150 mm	<b>AU 8000-2</b>
200 mm	<b>AU 8000-1</b>

## DIAMANTMESSER STANDARD DIAMOND KNIFE STANDARD





	181x49x18,5 mm	181x49x18,5 mm	181x49x18,5 mm
mit universal Silikonmatte/Tray Lid & Mat universal <b>ST 4601</b>			
für 1 Diamantmesser / for 1 diamond knife		<b>ST 4602</b>	
für 2 Diamantmesser / for 2 diamond knives			<b>ST 4603</b>

## SAFETY STERILIZATION BOX

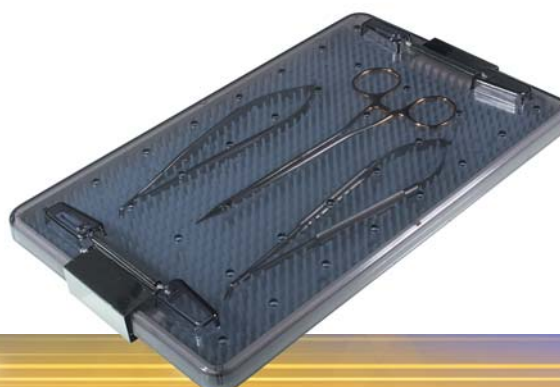

Einzelne waagrechte Schalen, Deckel und Matte (flach) <i>Single Level Tray, Lid and Mat (shallow)</i>	267x159x16 mm <i>Standard</i>	<b>ST 4609</b>
Einzelne waagrechte Schalen, Deckel und Matte (tief) <i>Single Level Tray, Lid and Mat (deep)</i>	267x159x35 mm	<b>ST 4610</b>
Doppelte waagrechte Schalen, Deckel und 2 Matten <i>Double Level Tray, Lid and 2 Mats</i>	267x159x35 mm	<b>ST 4611</b>

## LEVEL TRAYS

Präzision und Qualität zum besten Preis.  
 Finden Sie selbst aus erster Hand heraus, welche erstklassige chirurgische  
 Schärfe die ASANUS Aorta Stanzen zum besten Preis bieten.

*Precision, Quality and the Lowest Cost.  
 Find out firsthand how the ASANUS Aortic Punch has superior surgical  
 sharpness and the lowest cost.*

lange Ausführung  
 Long Assembly

Stanzengröße Punch Size	Artikelnummer Order number
2,8 mm	<b>GF 6628</b>
3,6 mm	<b>GF 6636</b>
4,0 mm	<b>GF 6640</b>
4,4 mm	<b>GF 6644</b>
4,8 mm	<b>GF 6648</b>
5,2 mm	<b>GF 6652</b>
5,6 mm	<b>GF 6656</b>
6,0 mm	<b>GF 6660</b>

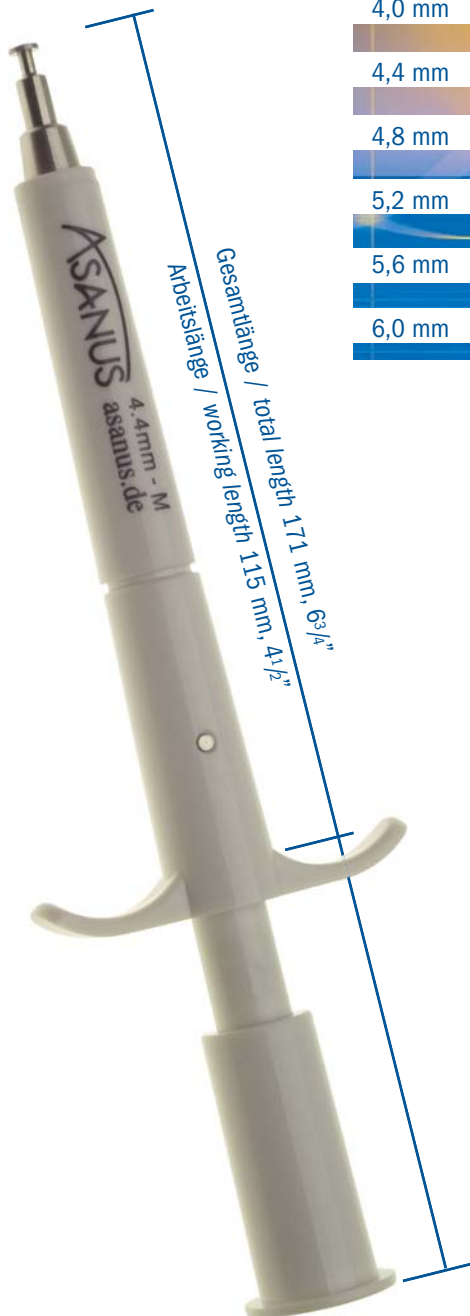

mittlere Ausführung  
 medium Assembly

Stanzengröße Punch Size	Artikelnummer Order number
2,8 mm	<b>GF 6528</b>
3,6 mm	<b>GF 6536</b>
4,0 mm	<b>GF 6540</b>
4,4 mm	<b>GF 6544</b>
4,8 mm	<b>GF 6548</b>
5,2 mm	<b>GF 6552</b>
5,6 mm	<b>GF 6556</b>
6,0 mm	<b>GF 6560</b>

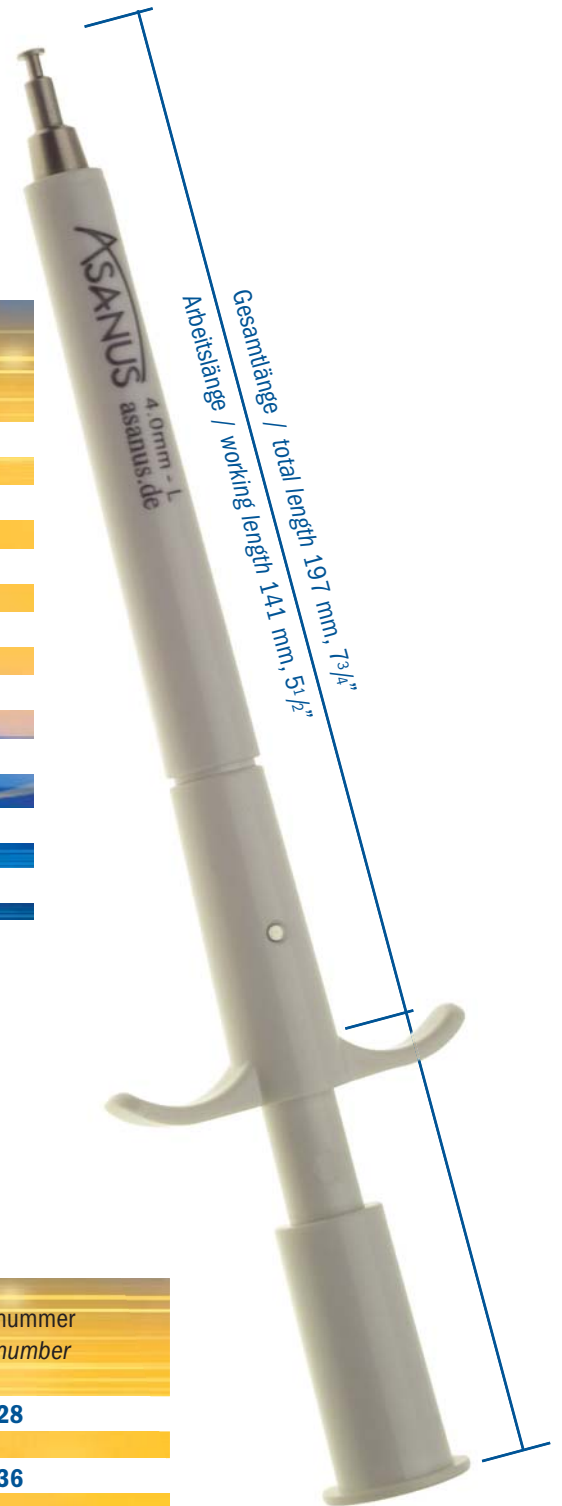

Latexfrei  
Latex free



Instrument Guards schützen die Instrumente vor Beschädigungen an den Spitzen und Kanten während der Bearbeitung und Sterilisation. Die Instrument Guards sind in neun verschiedenen Größen und drei Formaten erhältlich: undurchsichtig, klar oder rauchig, mit oder ohne Perforation (Löcher). Perforierte Guards reduzieren Feuchtigkeitsrückstände und erlauben das Eindringen von Dampf und Gas sowie leichtes Entfernen.

- Dampf- und gasdurchlässig
- Nicht steril
- Latex frei
- Undurchsichtige Guards sind röntgenfähig

Instrument Guards will protect instrument tips and edges from damage during handling and sterilization. Available in nine different sizes and three formats: opaque, clear, or tinted, with or without perforations (holes). Perforated guards reduce moisture residue, allows for steam and gas penetration and ease of removal.

- Steam and gas permeable
- Non-sterile
- Latex free
- Opaque guards are radiopaque

Größe Size	Maße Dimensions	Artikelnummer Productnumber
1 white	1,6 x 19 mm, 1/16" x 3/4"	DSP 121
2 blue	2,0 x 19 mm, 5/64" x 3/4"	DSP 122
3 green	2,8 x 19 mm, 64" x 3/4"	DSP 123
4 red	3,2 x 25,4 mm, 8" x 1"	DSP 124
5 yellow	4,8 x 25,4 mm, 3/16" x 1"	DSP 125
6 maroon	10,3 x 19 mm, 13/32" x 3/4"	DSP 126
7 orange	1,6 x 9,5 x 25,4 mm, 16" x 3/8"x1"	DSP 127
8 brown	1,6 x 15,9 x 25,4 mm, 5/64" x 5/8"x1"	DSP 128
9 black	3,2 x 25,4 x 25,4 mm, 1/8" x 1"x1"	DSP 129
Gemischte Packung Variety Pack		DSP 130

Instrumentenschutz gelocht, 100 Stück pro Packung  
Instrument Guards Perforated, 100 Guards per package

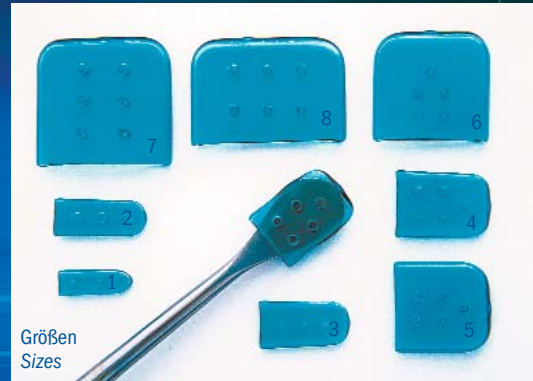

Größen  
Sizes

Osteotome Guards sind speziell zum Schutz der Osteotome während der Bearbeitung und Sterilisation entwickelt. Diese Guards schützen die Spitzen vor vorzeitigem Abstumpfen. Erhältlich in blau-perforiert.

- Dampf- und gasdurchlässig.

Osteotome Guards are specifically designed to protect osteotomes during sterilization and handling. These guards protect the tips from dulling prematurely or chipping. Available in blue tint perforated.

Steam and gas permeable.

Größe Size	Maße Dimensions	Arikelnummer Productnumber
1	5 x 15 mm, 1/4" x 3/4"	DSP 101
2	10 x 25 mm, 23/8" x 1"	DSP 102
3	13 x 25 mm, 1/2" x 1"	DSP 103
4	19 x 25 mm, 3/4" x 1"	DSP 104
5	25 x 25 mm, 1" x 1"	DSP 105
6	32 x 32 mm, 1 1/4" x 1 1/4"	DSP 106
7	38 x 38 mm, 1 1/2" x 1 1/2"	DSP 107
8	45 x 38mm, 1 3/4" x 1 1/4"	DSP 108

Instrumentenschutz gelocht, 50 Stück pro Packung  
Instrument Guards Perforated, 50 Guards per package

## INSTRUMENT GUARDS

## OSTEOTOME GUARDS

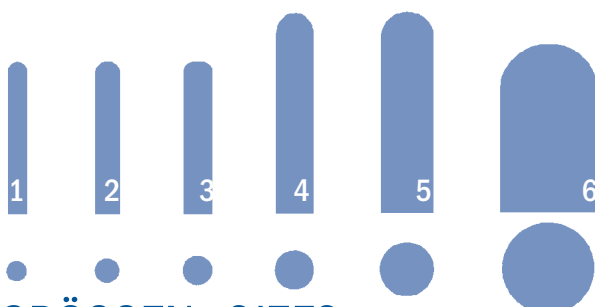

GRÖSSEN SIZES

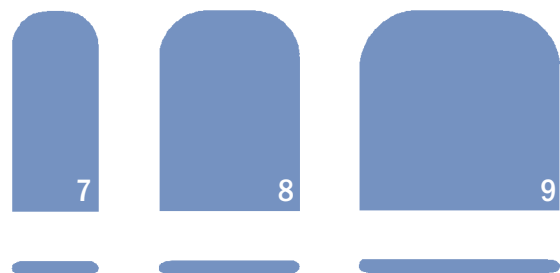

Latexfrei  
Latex free



Vascu-Loop erlaubt sichere und sanfte Abstellung, Verschluss und Identifikation der Gefäße während eines chirurgischen Eingriffs. Die elliptische Form erlaubt behutsame Handhabung der Arterien, Venen, Nerven, Sehnen, Samenstränge, Harnleiter oder wo sonst noch empfindliche Abstellung oder Verschiebung benötigt wird. Klemme und Retraktoren können die Gefäße flach drücken, die dadurch brechen oder unnötige Verletzung der Atheromem verursachen können. Die ovale Struktur der Gefäßbänder bietet ausreichende Spannung um den Durchfluss einzuschränken und können leicht entfernt werden ohne Abschürfungen zu verursachen.

Vascu-Loops permit safe smooth retraction, occlusion and identification of vessels during surgical procedures. The elliptical shape allows for gentle handling of arteries, veins, nerves, tendons, spermatic cords, ureters, or wherever delicate retraction/occlusion is required. Clamps and retractors can pinch the vessel flat, crack the intima, or create unnecessary trauma induced atheromas. The vascular ties' oval configuration provides sufficient tension to restrain flow and are easily removed without causing abrasion.

- medizinisches Silikon
- Röntgenfähig
- Zwei 16" Bänder pro sterilem Beutel
- Vier Farben / drei Größen
- Auch unsteril erhältlich

- Medical grade silicone
- Radiopaque
- Two 16" ties per sterile pouch
- Four colors / three sizes
- Also non-sterile available

Farbe Color	Mini Vascu-Loops	Maxi Vascu-Loops	Super Maxi Vascu-Loops
red	<b>DSP 001</b>	<b>DSP 005</b>	
blue	<b>DSP 002</b>	<b>DSP 006</b>	<b>DSP 009</b>
yellow	<b>DSP 003</b>	<b>DSP 007</b>	
white	<b>DSP 004</b>	<b>DSP 008</b>	

2 Bänder pro sterilem Beutel, 10 Beutel pro Packung

2 ties per sterile pouch, 10 pouches per box

## VASCU-LOOPS



Fadenklemm-Überzüge wurden entwickelt, um das Nahtmaterial zu schützen und zu halten ohne es dabei zu beschädigen.

Suture clamp tags are designed to protect and safely hold sutures without damage.

- Röntgenfähiges leuchtgelb zur besseren Erkennung
- Eingepackt in passenden Schaumstoff
- ungiftig
- abgezählt
- zwei, drei oder fünf Paare erhältlich
- steril oder unsteril
- Latex frei

- Radiopaque bright yellow for identification
- Packaged in convenient foam
- Non-toxic
- Pre-counted
- Available in 2, 3, or 5 pairs
- Sterile or non-sterile
- Latex free

Einheit Box	Farbe Color	Artikelnr. Productno.	
2 pairs/pouch	yellow	<b>DSP 012</b>	
3 pairs/pouch	yellow	<b>DSP 011</b>	
5 pairs/pouch	yellow	<b>DSP 010</b>	
5 pairs/pouch	assorted	<b>DSP 013</b>	
5 pairs/pouch	white	<b>DSP 014</b>	
5 pairs/pouch	blue	<b>DSP 015</b>	5 sterile Beutel pro Einheit
5 pairs/pouch	red	<b>DSP 016</b>	5 sterile pouches per box

## SUTURE CLAMP TAGS

Latexfrei  
*Latex free*



Vasca-Loops reduzieren Verletzungen an den Gefäßen bei Occlusionen, besonders da wo eine blutstillende Klemme eingesetzt wird. Die fadenähnlichen atraumatischen Vertiefungen erlauben sanfte, konstante und rutschfeste Spannung.

- medizinisches Silikon
- drei Farben
- zwei 5" Längen pro steriler Beutel
- Röntgenfähig
- Auch un-steril erhältlich
- latexfrei

*Vasca-Loops reduce trauma to vessels requiring occlusion, particularly where a hemostatic clamp is employed. The tread-like indents allow for gentle, constant, and non-slip tension.*

- Medical-grade silicone
- Three colors
- Two 5" lengths per sterile pouch
- Radiopaque
- Also available non-sterile
- Latex free

Maße <i>Dimensions</i>	Farbe <i>Color</i>	Artikelnr. <i>Productno.</i>
4 x 127 mm, 1/10" x 5"	red	<b>DSP 020</b>
7 x 127 mm, 2/10" x 5"	white	<b>DSP 021</b>
9 x 127 mm, 9 x 3/10" x 5"	blue	<b>DSP 022</b>

## CLAMP JAW COVERS



Der Identifikation Tape ist in zehn Farben und zwei Größen (1/4" und 1/8") erhältlich. Hält wiederholtem Sterilisieren stand.

*The Identification Tape is available in ten colors in 1/4" and 1/8" widths. Withstands repeated exposure to sterilization.*

Farbe <i>Color</i>	Breite 3 mm, width 1/8" Artikelnr. <i>Productno.</i>	Breite 6 mm, width 1/4" Artikelnr. <i>Productno.</i>
white	<b>DSP 070</b>	<b>DSP 080</b>
blue	<b>DSP 071</b>	<b>DSP 081</b>
green	<b>DSP 072</b>	<b>DSP 082</b>
red	<b>DSP 073</b>	<b>DSP 083</b>
yellow	<b>DSP 074</b>	<b>DSP 084</b>
purple	<b>DSP 075</b>	<b>DSP 085</b>
orange	<b>DSP 076</b>	<b>DSP 086</b>
brown	<b>DSP 077</b>	<b>DSP 087</b>
black	<b>DSP 078</b>	<b>DSP 088</b>
orange/red	<b>DSP 079</b>	<b>DSP 089</b>

## IDENTIFICATION TAPE

Die In-Situ-Bypass-Technik bei femoro-krualen Rekonstruktionen bietet folgende Vorteile:









- Verwendbarkeit auch sehr dünnkalibriger Venen (2 bis 4 mm)
- Geringere Traumatisierung der Vene als bei freier Entnahme
- Keine Knickung, Verdrehung oder Kompression der Vene
- Durchmesser-Angleichung der beidseitigen Anastomosen
- Deutlich bessere Funktionsergebnisse

*In-Situ-Bypass technic at femoro-crual reconstruction offers following advantages:*

- Usage of very thin veins (2 - 4 mm)
- lower trauntisation of vein than classic procedure
- no buckling, rotation, comprssion of veins
- harmonizing of diameters bothside of anastomosis
- postoperativ advanced function

Das Set **GF 2105** für diese spezielle OP-Technik besteht aus folgenden Artikeln:

*The Set **GF 2105** for this special operating technic consists of following articles:*

		GF 0018 Mikro Bulldogklemme DIETRICH, gewinkelt, 47 mm <i>Micro bulldog clamp, angled, 47 mm</i>
WH 5018      WH 5019 		WH 5018 KARMODY Sperrer, halbscharf, 80 mm, 3 Zähne <i>KARMODY retractor, semi sharp, 80 mm, 3 teeth</i>
		WH 5018-1 KARMODY Sperrer, stumpf, 85 mm, 9 kleine Zähne <i>KARMODY retractor, blunt, 85 mm, 9 small teeth</i>
		WH 5019 KARMODY Sperrer, halbscharf, 120 mm, 3 Zähne <i>KARMODY retractor, semi sharp, 120 mm, 3 teeth</i>
WH 5018-1      WH 5019-1 		WH 5019-1 KARMODY Sperrer, stumpf, 130 mm, 9 kleine Zähne <i>KARMODY retractor, blunt, 130 mm, 9 small teeth</i>
		GF 8030 TITAN Pinzette mit Ring, ohne Gegengewicht, 180 mm <i>TITAN forcep with ring, light weight, 180 mm</i>
		GFB 6318 BRILLIANT Mikro Stahlpinzette, diamantisiert, ohne Gegengewicht, 180 mm <i>BRILLIANT Micro steel forcep, Diamand Dust, light weight, 180 mm</i>
		NH 8010 TITAN Mikro-Nadelhalter, gerade, 185 mm <i>TITANIUM Micro needle holder, straight, 185 mm</i>
		YA 1350 Anlegezange Yasargil, 170 mm <i>Forcep Yasargil, 170 mm</i>



NHB 4520S TOPAS CASTROVIEJO Mikro Nadelhalter,  
 Diamand Dust, 140 mm  
*TOPAS CASTROVIEJO Micro needle holder,  
 Diamand Dust, 140 mm*



NHB 4526S TOPAS CASTROVIEJO Mikro Nadelhalter,  
 Diamand Dust, 185 mm  
*TOPAS CASTROVIEJO Micro needle holder,  
 Diamand Dust, 185 mm*



SC 0039 Mikroschere CORONAR, Flachgriff, 135 mm  
*Micro scissor CORONAR, flat handle, 135 mm*



SC 0067 Mikroschere, Flachgriff, 145 mm  
*Micro scissor, flat handle, 145 mm*



SC 0719 Schere JAMSON, gebogen, 150 mm  
*Scissor JAMSON, curved, 150 mm*



GF 0299 Valvenschere, 150 mm Arbeitslänge  
*Valve scissor, 150 mm working length*



GF 0294 Valvulotome LEATHER, 90° gewinkelt, 175 mm  
*Valvulotome LEATHER, 90° angled, 175 mm*



MN 1839 RHOTON Häkchen, stumpf, 180 mm  
*RHOTON micro hook, blunt, 180 mm*



	Seite		Seite		Seite
<b>A</b>		<b>Bulldogklemmen</b>	125, 128 - 131	<b>DE BAKEY BISHOP Gefäßklemmen</b>	222
Abdominale Anastomosenklemme	227	<b>Bulldogklemmen atraumatisch</b>	207, 213	<b>DE BAKEY Bulldogklemmen</b>	126, 128, 213
ACLAND Clipse	137	<b>BURFORD Kindersperrerr</b>	175	<b>DE BAKEY Coarctationsklemmen</b>	195
ADSON (BABY) CONE Wundspreizer	165	<b>C</b>		<b>DE BAKEY DERRA Anastomosenklemme</b>	225
ADSON Anatomische Pinzetten	35	<b>Cardio Wundhaken</b>	139	<b>DE BAKEY FEMUr Wundspreizer</b>	167
ADSON Arterien- und Präparierklemmen	271	<b>Carotis delicate Gefäßklemmen</b>	190	<b>DE BAKEY Gefäßklemmen 189, 206, 219, 220, 242</b>	189, 206, 219, 220, 242
ADSON Arterienklemmen	258	<b>Carotis-Spreizer</b>	168	<b>DE BAKEY Gefäßklemmen</b>	193, 194
ADSON Chirurgische Pinzetten	41	<b>Carotisklemmen</b>	229	<b>DE BAKEY Gefäßpinzetten</b>	31
ADSON Power TC Pinzetten	42, 43	<b>CASTANEDA Gefäßklemmen</b>	188, 190	<b>DE BAKEY GLOVER Aortaklemmen</b>	232
ADSON Präparierklemmen	267	<b>CASTANEDA Sternal Rippensperrerr</b>	178	<b>DE BAKEY GLOVER Coarctation clamps</b>	239
ADSON Wundspreizer	165	<b>CASTROVIEJO Mikro Stahl Nadelhalter</b>	12	<b>DE BAKEY GLOVER Gefäßklemmen</b>	216, 217, 239
ALLISON Lungenspatel, Organspatel	158	<b>Chirurgische Einmalprodukte</b>	314, 315	<b>DE BAKEY HARKEN Gefäßklemmen</b>	231, 245
ALM Wundspreizer	164	<b>Chirurgische Pinzetten</b>	39 - 41	<b>DE BAKEY Isolierte Pinzetten</b>	48
AMATO Klemmen	205	<b>Chirurgische Scheren</b>	76 - 82	<b>DE BAKEY KELLY Gefäßklemmen</b>	217
Anastomosenklemmen	203, 225, 284	<b>Chirurgische Scheren POWER TC</b>	108 - 113	<b>DE BAKEY Kinderaortaklemme</b>	196
ANATOMIC Mikro Titan Pinzetten	27	<b>Chirurgische Scheren SUPERCUT</b>	93 - 98	<b>DE BAKEY Lungenklemmen</b>	286
Anatomische Pinzetten	35 - 38	<b>CHITWOOD DE BAKEY Klemme</b>	289	<b>DE BAKEY Mehrzweckgefäßklemmen</b>	191, 192
ANDREWS- PYCHON Sauger	297	<b>Clamp Jaw Covers</b>	315	<b>DE BAKEY Mikro-Pinzetten</b>	24
Anlegepinzetten	130, 131, 137	<b>CLEVELAND Gefäßklemmen</b>	204	<b>DE BAKEY MIXTER Ligaturklemme</b>	224
Anlegezange Yasargil	316	<b>CLIP-APPLIKATOREN</b>	131	<b>DE BAKEY MIXTER Präparierklemmen</b>	274
Anlegezangen	135	<b>Clipse</b>	137, 138	<b>DE BAKEY MOSQUITO Gefäßklemmen</b>	217
AORTA STANZEN	312	<b>Coarctationsklemmen</b>	195, 226, 239	<b>DE BAKEY Nadelhalter</b>	16
AORTA STANZEN DOUBLE CUTTER	295	<b>Combi-SPECIAL Knüpf- und Nahtpinzette</b>	25	<b>DE BAKEY Patent Ductusklemmen</b>	194
Aortaklemmen	232, 234 - 238, 241	<b>Container</b>	311	<b>DE BAKEY PEAN Gefäßklemmen</b>	218
Arterien- und Präparierklemmen	270 - 272	<b>COOLEY Anastomosenklemme</b>	203	<b>DE BAKEY ppheriph. Gefäßöffelklemme</b>	195, 196
Arterienklemmen	260 - 266	<b>COOLEY Aortaklemmen</b>	236, 237	<b>DE BAKEY Pinzetten</b>	30
Atraumatik Pat. Ductus Klemmen	216	<b>COOLEY Atraumatische Pinzetten Stahl</b>	44	<b>DE BAKEY Präparierscheren</b>	90, 91
Atraumatische Gefäßklemmen	217 - 239	<b>COOLEY Bulldogklemmen</b>	207	<b>DE BAKEY Präparierscheren POWER TC</b>	122
Atraumatische Stahl Pinzetten	44, 45	<b>COOLEY Coarctationsklemme</b>	226	<b>DE BAKEY RANKIN Gefäßklemmen</b>	217
Atraumatische Titan-Gefäßpinzetten	31, 32	<b>COOLEY DERRA Gefäßklemmen</b>	226	<b>DE BAKEY Rippensperrerr</b>	180
Atraumatische Zahnungen	187	<b>COOLEY Flexible Gefäßklemmen</b>	228	<b>DE BAKEY SAPHENO-FEMORALIS Klemme</b>	197
AUSTIN Mikro-Knüpfpinzette	34	<b>COOLEY Gefäßklemmen</b>	208 - 233	<b>DE BAKEY SATINSKY Bulldogklemmen</b>	128
		<b>COOLEY Gefäßklemmen TITAN</b>	212	<b>DE BAKEY SATINSKY Gefäßklemmen</b>	243
<b>B</b>		<b>COOLEY ILLIAC Clamps</b>	236	<b>DE BAKEY SATINSKY Vena Cava Klemme</b>	245
BABY CRILE-WOOD Nadelhalter	15	<b>COOLEY Mehrzweckklemmen</b>	224	<b>DE BAKEY Sauger</b>	300
BABY SENN-MILLER Wundhaken	142	<b>COOLEY Mitral-Valven-Haken</b>	169	<b>DE BAKEY Scheren</b>	60
BABY-ADSON Präparierklemmen	267	<b>COOLEY Patent Ductus Gefäßklemmen</b>	221	<b>DE BAKEY SEMB Aortaklemmen</b>	238
BABY-MIXTER Arterienklemmen	272	<b>COOLEY SATINSKY Gefäßklemmen</b>	244	<b>DE BAKEY Tangentialklemmen</b>	202, 203
BABY-MIXTER Präparierklemmen	267	<b>COOLEY Saugrohr</b>	297, 299	<b>DE BAKEY Titan Gefäßpinzetten atraumatisch</b>	32
BABY-ROUX Wundhaken	161	<b>COOLEY Tangential Occlusion Klemmen</b>	235	<b>DE BAKEY-Titan Bulldogklemmen</b>	213
BABY-SATINSKY Anastomosenklemmen	284	<b>COOLEY Vena-Cava-Klemmen</b>	252	<b>DE BAKEY-COMBI Pinzetten</b>	29
BACKHAUS Tuchklemmen	248	<b>COOLEY REMOLE RETRACTOR SET</b>	172	<b>DEAVER Wundhaken und Lungenspatel</b>	156, 157
BACKHAUS-CLIP Tuchklemmen	248	<b>COOPER TITANIT Scheren</b>	73	<b>DEBAKEY Fasszangen PEN LINE</b>	291
BAILEY Rippensperrerr	182	<b>COOPER-SLIM TITANIT Scheren</b>	74	<b>DEBORAH-CASTANEDA periph. Gefäßklemmen</b>	197
BAILEY Rongeur	181	<b>CORONAR SLIM-LINE Arterienklemme</b>	271	<b>DEBORAH-CASTANEDA Tangentialklemmen</b>	198
BAILY Micro Arterien- und Präparierklemmen	271	<b>CRILE Arterienklemmen</b>	257	<b>DEBUS Schere</b>	59
BAINBRIDGE DE BAKEY Gefäßklemmen	221	<b>CRILE Nadelhalter</b>	20	<b>DELICATE Nadelhalter</b>	4
BAJO Nadelhalter	6	<b>CRILE-RANKIN Arterienklemmen</b>	258	<b>Delikate und feine Scheren</b>	75
Bauch- und Darmspatel	163	<b>CRILE-WOOD Nadelhalter</b>	15	<b>Delikate und feine Scheren SUPERCUT</b>	92
Bauchdeckenschere	73	<b>CROSS ACTION Nadelhalter</b>	6	<b>DERF Nadelhalter</b>	15
BECKMANN Wundspreizer	166	<b>CROSS Instrumente, Titan</b>	26	<b>DERRA Gefäßklemmen TITAN</b>	212
BECKMANN-ADSON Wundspreizer	166	<b>CROSS OVERHOLT Präparierklemmen</b>	281	<b>DERRA Tangentialklemmen</b>	199
BENGOLA Arterienklemmen	259	<b>CUSHING Anatomische Pinzetten</b>	38	<b>DESMARRES Wundhaken</b>	140
BERRY Drahtspannzange	19	<b>CUSHING Power TC Pinzetten</b>	42	<b>Diamantmesser</b>	310
BETHUNE Rippenscheren	184	<b>CUSHING Wundhaken</b>	143, 144	<b>DIETHRICH Aortaklemmen</b>	235
Bipolares Koagulations-Pinzettensystem	46	<b>D</b>		<b>DIETHRICH Bulldogklemmen</b>	125
BiTIP Pinzetten	46, 47	<b>DARDIK Gefäßklemmen</b>	215	<b>DIETHRICH DE BAKEY Bulldogklemmen</b>	125
BONN delikate und feine Scheren	75	<b>DAVIDSON Scapula-Haken</b>	158	<b>Dissector Titan</b>	301
BONN Titanit Scheren	62	<b>DE BAKEY Anastomosenklemme</b>	225	<b>Dissectoren</b>	301
BOZEMANN Nadelhalter	18	<b>DE BAKEY Aortaklemmen</b>	236, 237, 241	<b>Distale Aortaklemmen</b>	247
BRILLIANT Mikro Stahlpinzette	316	<b>DE BAKEY Atraumatische Pinzetten Stahl</b>	44	<b>DOLPHIN Suture Organizer</b>	251
Brilliant Scheren	61	<b>DE BAKEY BAHNSON Aortaklemmen</b>	237	<b>DOYEN Tuchklemmen</b>	248
BROMTON Schlauchroller	249	<b>DE BAKEY BECK Gefäßklemmen</b>	206, 242		
Bronchusklemmen	282 - 285			<b>E</b>	
BULLDOG SHUNT KLEMME	126			<b>Einmalprodukte</b>	312



# Index Artikelbeschreibung

## Index Item Description

	Seite		Seite		Seite
EISELSBERG TITANIT Scheren	74	<b>H</b>		KOCHER- LANGENBECK Wundhaken	148, 149
ELEGANCE Nadelhalter	6, 13	HAGMÜLLER Carotis-Spreizer	168	KOCHER-OCHSNER Arterienklemmen	265, 266
ELEGANCE Sure Grip Mikro-Fasspinzetten	26	HAGMÜLLER Wundspreizer	168	Kombi-PinStripper	304
ELEGANCE CROSS-ACTION Knüpfpinzetten	26	HAJEK Drahtspannzange	19	KÖNIG Wundhaken	140
ENDO-Nadelhalter	289	HAJEK Nadelhalter	18	Kornzangen	253
ERGONOMY Nadelhalter	11	HAJEK TITANIT Scheren	70	Kräftige Titanit® Scheren	72
EUPHRATE-PASQUE Nadelhalter	13	HALSTED-FINO Arterienklemmen	272	KRÖNLEIN Schlauchklemmen	249
<b>F</b>		HARKEN Gefäßklemmen	245	<b>L</b>	
Fadenzieher	139	HARRINGTON Bronchusklemmen	282	LAHEY Gallenkanal Klemmzange	272
FARABEUF Wundhaken	162	HARRINGTON Wundhaken und Lungenspatel	155	LAMBERT-KAY Gefäßklemme Titan	212
Feine Arterienklemmen	256 - 259	HEISS Arterienklemmen	259	LAMBERT-KEY COOLEY Aortaklemmen	234
Feine Präparierklemmen	255	Heparin Kanüle	310	Laminektomie Spreizer	166
Feine TITANIT® Präparierscheren	65	Herz-Thorax Sperrer	170 - 180	Lange Titanit® Scheren	69
Feine Titanit® Scheren	62 - 64	Herz-Thorax Sperrer für Kinder	176, 177	LANGENBECK Nadelhalter	20
Feine Wundhaken	141	HOFFMANN Kombi-PinStripper	304	LANGENBECK Wundhaken	146, 147
Filliformspitze	305	HOLLE Arterien- und Präparierklemmen	270	LEBSCHKE Meissel	182
FINOCHIETTO BABY HAIGHT Rippensperrer	177	HOLLE Präparierklemmen	273	LEES Bronchusklemmen	285
FINOCHIETTO Herz-Thorax Sperrer	175	<b>I</b>		LEITZ COOLEY Teilverschlußklemme	210
FINOCHIETTO INFANT Rippensperrer	177	I.M.A. Epicarteur	309	LELAND-JONES DE BAKEY Gefäßklemmen	220, 221
FINOCHIETTO-BURFORD Herz-Thorax Sperrer	174	I.M.A. RETRACTOR	173, 174	LERICHE Arterienklemmen	257
FINSEN Wundspreizer	164	Identification Tape	315	Level trays	311
FITZGERALD Aortaklemmen	238	ILLIACA Klemmen	236	LEXER Präparierscheren	85
FLAT HANDLE Nadelhalter	5	IN-SITU-BYPASS INSTRUMENTENSET	316, 317	LEXER Präparierscheren POWER TC	114
Flexible Gefäßklemmen	228	Infragenualer Retraktor	171	LEXER Präparierscheren SUPERCUT	101
FOERSTER Schwammzangen	254	Instrument Guards	313	LEXER TITANIT Scheren	71
FOGART ATRAUMATIC "MULTI CHANGE" Klemmen	246	Instrumentenschutzhülsen	313	Ligaturklemmen	224, 269, 276
<b>G</b>		IORIO Aorta dissecting clamps	270	LILLEHEY POTTS Präparierscheren POWER TC	122
Gallenkanal Klemmzange	272	IORIO Arterienklemmen	270	LILLEHEY POTTS Präparierscheren SUPERCUT	106
GARRET Vascular Dilators	294	IORIO Sauger	298	LILLEHEY-POTTS TITANIT Präparierscheren	66
Gefäß-Dilatatoren	294	IORIO Tube organizer	251	LINZ Mikro Titan Pinzetten	28
Gefäß-Schere DE BAKEY	60	IRIS Titanit Scheren	62	LINZ Mikro-Pinzetten	33
Gefäßklemmen	224 - 246	Irisscheren	75	LISTER TITANIT Scheren	74
Gefäßklemmen atraumatisch	214 - 216, 219	Irisscheren POWER TC	108	Lungenklemmen	286
Gefäßklemmen f. den Herzvorhof	231	Irisscheren SUPERCUT	92	Lungenspatel	155 - 158
Gefäßklemmen f. die Arterien der Niere	227	Isolierte Pinzetten	48	<b>M</b>	
Gefäßklemmen f. Kinder	208 - 210	ISRAEL Wundhaken	145	MARBERGER Wundhaken	143
Gefäßklemmen f. Kinderchirurgie	188 - 206	<b>J</b>		Markierungsprodukte	315
Gefäßklemmen f. Tangential-Verschluss	242	JACOBSEN Gefäßklemmen	255	MATHIEU Bauch- und Darmspatel	163
Gefäßklemmen TITAN	211, 212	JAMESON Präparierklemme	83	MATHIEU Nadelhalter	20, 21
Gefäßsauger	289	JAMESON-WERBER Titanit Scheren	64	MATHIEU Wundhaken	162
Gefäßscheren	90	JAVID Gefäßklemmen	229	MATHIEU-KOCHER Nadelhalter	20
Gefäßtunneler	295	JOHNS HOPKINS Anlegepinzette	130	MAYO Chirurgische Scheren POWER TC	113
GELPI Vulva-Spreizer	167	JOHNS HOPKINS Bulldogklemmen	130	MAYO FINO TITANIT Scheren	71
GELPI Wundspreizer	167	JONES Tuchklemmen	248	MAYO Präparierscheren SUPERCUT	100
GEMINI MINI Präparier- und Ligaturklemmen	277	JOSEPH Titanit Scheren	63	MAYO Sortierklemme	248
GEMINI Präparier- und Ligaturklemmen	277	<b>K</b>		MAYO Standard Präparierscheren	84
GERALD DE BAKEY Gefäßpinzetten	45	KANÜLEN	296	Mayo TITANIT Scheren	72
GERALD Mikro Titan Pinzetten	27	KARMODY Sperrer	309, 316	MAYO-ADAMS Wundspreizer	288
GERALD Mikro-Pinzetten	25	KELLY Arterienklemmen	257	MAYO-HEGAR Nadelhalter	17
GERALD Pinzetten	29	KELLY Bauchdeckenhaken	160	MAYO-LEXER Präparierscheren	85
GIERTZ-STILLE Rippenscheren	183	KERSTING Abdominale Anastomosenklemme	227	MAYO-LEXER Präparierscheren POWER TC	114
GILLIES Chirurgische Pinzetten	41	KILNER Chirurgische Scheren	82	MAYO-LEXER Präparierscheren SUPERCUT	101
GLASGOW f. Präparation der Mammaria	57	KILNER Chirurgische Scheren POWER TC	111	MAYO-STILLE Chirurgische Scheren POWER TC	112
GLOVER Bulldogklemmen	129	KILNER Chirurgische Scheren SUPERCUT	98	MAYO-STILLE Präparierscheren	83
GOLF Scheren	59	KILNER TITANIT Präparierscheren	65	MAYO-STILLE Präparierscheren SUPERCUT	99
GRAEFE Anatomische Pinzetten	35	Kinder- u. Erwachsenen Gefäßklemmen	193, 194	MAYO-STILLE TITANIT Scheren	71
GRAEFE Chirurgische Pinzetten	40	Kinderaortaklemme	196	MC INDOE Chirurgische Pinzetten	28, 41
GREGORY Bulldogklemmen	128	Klemmenaufbau	186	MEEKER Präparier- und Ligaturklemmen	276
GREGORY PROFUNDA Gefäßklemmen	214, 219	Knotenschieber PEN LINE	291	Mehrzweck-Gefäßklemmen	191, 192
GROSS Kornzange	253	Knüpf- u. Nahtpinzetten	25	Mehrzweckklemmen	224, 241, 242
GROSS-MAIER Kornzange	253	KOCHER Arterienklemmen	260	Mehrzweckklemmen f. die Neonatalchirurgie	190
GUNNAR-HEY Schlauchroller	249	KOCHER Wundhaken	150 - 154	Meissel	182
				MERCEDES Rippensperrer	180

	Seite		Seite		Seite
MERLO Distale Aortaklemmen	247	Minimal Invasive Chirurgie	292	Präparierscheren POWER TC	114 - 122
Metallsondenspitze	305	MIS Instrumente	287 - 289	Präparierscheren SUPERCUT	99 - 107
METZENBAUM FINO TITANIT Scheren	68, 69	MITRA Mitral-Klappen-Sperrer	170	Präparierscheren SUPERCUT für Thorax- und Hysterektomie	107
METZENBAUM LIGHT Präparierscheren SUPERCUT	106	Mitral-Klappen-Sperrer	170	PRICE-THOMAS Bronchusklemmen	283
METZENBAUM MINI STRABISMUS Scheren	66	Mitral-Valven-Haken	169	PROVIDENCE-HOSPITAL Arterienklemmen	256
METZENBAUM Präparierscheren POWER TC	120, 121	MIXTER Präparierklemmen	268, 275	PYRAMID Gefäßklemmen	255
METZENBAUM Präparierscheren SUPERCUT	104, 105	MOBERG Wundhaken	139		
METZENBAUM Standard Präparierscheren	88, 89	MOD. MILLS VALVULOTOME	308		
METZENBAUM TITANIT Scheren	68, 69	MORRIS Aortaklemmen	232	<b>R</b>	
METZENBAUM ULTRA EXTREM TITANIT Scheren	67	MORSE Sternal Rippensperrer	178	RAGNELL Wundhaken	142
METZENBAUM ULTRA FINO TITANIT Scheren	67	MUELLER Mikro-Pinzetten	33	RAGNELL-TUULA TITANIT Präparierscheren	65
METZENBAUM ULTRA-FINO Präparierscheren POWER TC	115, 116	MÜLLER Clipse	138	RAMPLEY Schwammzangen	254
METZENBAUM-DELICATE TITANIT Scheren	67	<b>N</b>		RESANO CROSS-ACTION Pinzetten	26
METZENBAUM-FINO Präparierscheren POWER TC	117 - 119	NABATOFF Venenstripper Set	305	RESANO Gefäßpinzetten	45
METZENBAUM-FINO Präparierscheren SUPERCUT	102, 103	Nadelhalter PEN LINE	290	REYNOLDS Chirurgische Scheren POWER TC	112
METZENBAUM-FINO Standard Präparierscheren	86, 87	NEONATAL Renalklemmen	204	REYNOLDS Präparierscheren	83
METZENBAUM-S TITANIT Scheren	70	Nitinol Anlegezange	135	REYNOLDS Präparierscheren SUPERCUT	99
MICRO-CARDIO Nadelhalter	11	Nitinol Gefäßsonden	294	REYNOLDS Titanit Scheren	64
MICRO-DELICATE Nadelhalter	8	NOON Gefäßstuneler	295	REYNOLDS-JAMESON Chirurgische Scheren	82
MICRO DELICATE Titan Pinzetten	27	<b>O</b>		RHOTON Häkchen	317
MICRO-Dissector	301	OCHSNER Aortaklemmen	234	RHOTON Wundhaken	139
MICRO FINOCHIETTO Sperrer	176	OEHLER Power TC Pinzetten	43	RICHARDSON Wundhaken	154
MICRO HALSTED-MOSQUITO Arterienklemmen	256	Oliven	304, 305	Ring Stripper	304
MICRO JACOBSON Gefäßklemmen	255	ONIX Nadelhalter	10	Ringgriffscheren	59, 60
MICRO KITZMILLER Gefäßklemmen	211	Organspatel	158	Ringnadelhalter, Titan und Stahl	13
MICRO Nadelhalter	8	Osteotome Guards	313	Ringtip Mikro-Pinzetten	24, 30
MICRO-OVERHOLT Arterien- und Präparierklemmen	271	OVERHOLT delikate Präparierklemmen	279	Rippen- und Sternalscheren	183
MICRO PEDRIATIC DE BAKEY Gefäßklemmen	211	OVERHOLT N. SUEMERMANN Präparierklemmen	281	Rippenhalter	182
MICRO SLIM LINE potts Scheren	58	OVERHOLT Präparier- und Ligaturklemmen	276	ROBERTS Arterienklemmen	261
MICRO Stahl Nadelhalter	9	OVERHOLT SLIM LINE Präparierklemmen	278	ROCHESTER-PEAN Arterienklemmen	264
MICRO SWAN SCHEREN	50 - 54	OVERHOLT- GEISSENDOERFER Präparier- und Ligaturklemmen	280	Rongeurs	181
MICRO Vascular Nadelhalter	14	OVERHOLT-S Präparierklemmen	279	ROUX Wundhaken	161
MICRO-TITAN Nadelhalter	13	<b>P</b>		RÜHLAND Saugrohr	299
MIDDELDORF Wundhaken	153	Päivi für Nahtfixation	302	RUMEL-BELMONT Gefäß-Instrumente	303
Mikro Bulldogklemme DIETRICH	316	PARKER-LANGENBECK "US ARMY" Wundhaken	161	RUSSIAN Chirurgische Pinzetten	39
Mikro Pinzetten	33	Patent Ductusklemmen	194	RYDER "FRENCH EYE" Nadelhalter	17
Mikro Pinzetten, Stahl	30	PEACOCK Mikro Stahl Scheren	56	RYDER Nadelhalter	14
Mikro Ringgriffscheren	58	PEAN Arterienklemmen	260, 263	<b>S</b>	
Mikro Scheren Delikat	57	PEERS Tuchklemmen	248	SAFETY sterilization box	311
Mikro Skalpellgriff	124	PEN LINE	290, 291	"SALZBURGER" SPATEL	301
Mikro Stahl Nadelhalter	9 - 11	PEN Nadelhalter	7	SALZBURG TITANIT Präparierscheren	65
Mikro Stahl Pinzetten	29	Periphere Gefäßklemmen	197	SALZBURG Titanit Scheren	64
Mikro Stahl Scheren	51, 52	Peripheralklemmen	215	SAPHENO-FEMORALIS Klemme	197
Mikro Stahl Scheren, bajonett	56	Pheripehrale Gefäßlöfkelklemme	195, 196	SAROT Arterienklemmen	262
Mikro Titan Pinzetten	27, 28	Phlebologie Instrumente	306, 307	SAROT Bronchusklemmen	282
Mikro TITANIT® Scheren	55	PILZNER Saugrohr	299	SAROT Nadelhalter	16
Mikro-Bulldogklemmen TITAN	127	Pin Stripper	304	SATINSKY "MOD. NEUHAUS" Gefäßklemmen	240
Mikro-Cardio u. Gefäß-Instrumente	309, 310	Plastic Titanit Scheren	63	SATINSKY Anastomosenklemmen	284
Mikro-Cardio und Gefäß-Instrumente	294, 295, 302 - 305	Plateau Mikro-Pinzetten	24	SATINSKY Präparierscheren	91
Mikro-Fasspinzetten, Titan	25	Plateau Pinzetten	30	SATINSKY Präparierscheren SUPERCUT	107
Mikro-Knüpppinzetten	34	POPLITEA Sperrer	171	SAUERBRUCH Rippenscheren	183
Mikro-Nadelhalter	8	Potts Scheren	58	SAUGER	298 - 300
Mikro-Nadelhalter, Titan	2, 5, 7, 16, 18, 50	POTTS-SMITH Chirurgische Pinzetten	39	Saugrohr	299
Mikro-Pinzetten, Titan	24	POTTS-SMITH Power TC Pinzetten	38, 42	SAUGROHRE	296
Mikro Wundhaken	139	POTTS-SMITH Scheren	59	Schere JAMSON	317
Mikroschere CORONAR	317	POWER TC Drahtspannzangen	19	Scheren PEN LINE	290
Mikroschere, Flachgriff	317	POWER TC Nadelhalter	14 - 21	Schlauchklemmen	249, 250, 251
MIKULICZ Bauchdeckenhaken	159	POWER TC Pinzetten	42, 43	Schlauchroller	249
Mini-Bulldogklemmen	126	Präparier- und Ligaturklemmen	276 - 280	Schlauchziehklemme	286
MINI-LANGENBECK Wundhaken	140	Präparierklemmen	267 - 281	SCHMIEDEN- TAYLOR TITANIT Scheren	74
		Präparierscheren	83 - 91	SCHUHMACHER Rippenscheren	183
				Schwammzangen	253, 254
				SCHWARTZ Anlegepinzette	130
				SCHWARTZ Bulldogklemmen	130

# Index Artikelbeschreibung

## Index Item Description

	Seite		Seite
SEMB Ligaturklemmen	269	Trokare	287
SEMKEN Anatomische Pinzetten	35	Tuchklemmen	248
SEMKEN Chirurgische Pinzetten	40	Tunnelierungsinstrument	303
SEMKEN Power TC Pinzetten	42	Tunnelierungsscheren	90
SENN-GREEN Wundhaken	142	Tupferzangen	253
SENN-MILLER Wundhaken	142	TUULA PANKREAS TITANIT Präparierscheren	65
SHUNT Flexible Gefäßklemmen	228	TUULU Präparierklemmen	275
Sicherheitsmesser	310		
SIMS TITANIT Scheren	72	<b>U</b>	
Skalpelli	124	Uhrmachermodelle Pinzetten	34
SLIM LINE POTTS Scheren	58	ULRICH Kornzangen	253
SLIM LINE SWAN Scheren	50 - 54		
SMOOTH Mikro-Fasspinzetten	25	<b>V</b>	
Soft Cover	159, 160	Valvensperrer FPR DIE MINI Thoracotomy	292
Softgrip Micro Bulldogklemmen	126	VALVULOTOMIE INSTRUMENTE	308
Sortierklemmen	248	Valvulotomie Scheren	308, 317
SPATEL	301	Valvulotome LEATHER	317
SPENCER-WELLS Arterienklemmen	260	VARADY Phlebologie Instrumente	306, 307
Spül- und Saugrohre	296, 297	Vascu-loops	314
Standard Anatomische Pinzetten	36	Vascular Sauger	297
Standard chirurgische Pinzetten	41	Vena-Cava-Klemmen	245, 252
Standard Chirurgische Pinzetten	37, 40	Venenhaken	140
Standard Chirurgische Scheren	76 - 81	Verbandstoffschere	74
Standard Chirurgische Scheren POWER TC	108 - 110	VIGANO Gefäßklemmen	239
Standard Chirurgische Scheren SUPER CUT	93 - 97	VIGANO Gefäßsauger	289
Standard Mikro Stahl Scheren	52	VIGANO Sauger	300
Standard MIKRO TITANIT Scheren	55	WISE Mikro-Knüpfpinzette	34
Stanzen	295	VOLKMANN Wundhaken	144
Sterilisationscontainer	311		
Sternum Meissel	182	<b>W</b>	
Sternum Retraktor	173	WAHL Mikro Titan Pinzetten	27
Sternum Scheren	183	WAUGH chirurgische Pinzetten	39
Sternum-Sperrer für Mamaria Arterie	173	WEBER Aortaklemmen	235
STEVENS Chirurgische Scheren	82	WEBSTER Nadelhalter	15
STEVENS Chirurgische Scheren POWER TC	111	WEITLANER Wundspreizer	164
STEVENS Chirurgische Scheren SUPER CUT	98	WILMER delikate und feine Scheren	75
STEVENS Titanit Scheren	62, 64	Wund- und Venenhaken	140, 143, 144
STRANDELL-STILLE Wundhaken	144	Wundhaken, Bauchdeckenhaken	159, 160
STRELI Arterien- und Präparierklemmen	270	Wundhakenbezüge	159, 160
Stripper	303, 304	Wundspreizer	164 - 168
Struma Chirurgie	273	WYLIE Hypogastrik Klemmen	223
Suture clamp tags	314		
		<b>Y</b>	
<b>T</b>		YANKAUER Sauger	300
Tangentialklemmen	198 - 203, 235	YASARGIL Aneurysma Clipse	132 - 136
TAYLOR Anatomische Pinzetten	38	YASARGIL Anlegezange	135
TAYLOR Chirurgische Pinzetten	39	YASARGIL Saugkanülen	296
TEALDI Gefäßklemmen	190, 229		
Teilverschlussklemme	210	<b>Z</b>	
Thorax-Trokare	287	ZENKER Arterienklemmen	262
THOREK Präparierscheren	91	ZENKER Wundhaken	151
TIGER Nadelhalter	7	Zugseil	305
TITAN FINOCHIETTO Sperrer	176	ZWEIFEL Nadelhalter	21
TITAN Mikro-Nadelhalter	316		
TITAN Pinzette	316		
TITANIT® Metzenbaum Scheren	67, 68		
Titanit® Präparierscheren	66		
Titanit® Scheren	53 - 55, 58 - 74		
TOENNIS Arterienklemmen	261		
TOENNIS-ADSON Scheren	66		
TÖNNIS-ADSON Präparierscheren	90		
TÖNNIS-ADSON Präparierscheren POWER TC	122		
TÖNNIS-ADSON Präparierscheren SUPER CUT	106		
TOPAS CASTROVIEJO Mikro Nadelhalter	317		
TOPAS Nadelhalter	12		

### ACHTUNG

Sämtliche chirurgische Instrumente dürfen ausschließlich im Verhältnis zur Bauart eingesetzt werden, z.B. dürfen feine Schere nur zum Schneiden von feinstem Gewebematerial eingesetzt werden. Scheren dürfen nicht zum Schneiden von harten Materialien, insbesondere Kalk, verwendet werden. Asanus übernimmt keine Gewährleistung für alle auftretenden Schäden durch unsachgemäße Handhabung der Instrumente.

	page		page		page
<b>A</b>		BULLDOG SHUNT CLAMP	126	DE BAKEY atraumatic forceps steel	44
Abdominal anastomosis clamps	227	BURFORD children retractor	175	DE BAKEY atraumatic forceps TITANIT	32
Abdominal and intestinal spatulas	163	<b>C</b>		DE BAKEY BABY bulldog clamps	213
Abdominal scissor	73	Cable flexible	305	DE BAKEY BAHNSON aortic clamps	237
ACLAND clipse	137	Canulas	296	DE BAKEY BECK vascular clamps	206, 242
ADSON (BABY) CONE wound retractors	165	Cardio hook retractors	139	DE BAKEY BISHOP vascular clamps	222
ADSON delicate haemostatic forceps	258	Cardio thoracic retractor	170 - 180	DE BAKEY bulldog clamps	126, 128, 213
ADSON dissecting forceps	267	Cardio thoracic retractor for children and infants		DE BAKEY coarctation clamp	195
ADSON dressing forceps	35			DE BAKEY-COMBI forceps	29
ADSON haemostatic-dissecting forceps	271			DE BAKEY DERRA anastomosis clamps	225
ADSON tissue forceps	41	Carotid clamps	229	DE BAKEY dissecting scissors	91, 98
ADSON Power TC forceps	42, 43	Carotid delicate vascular clamps	190, 229	DE BAKEY dissecting scissors POWER TC	122
ADSON wound retractors	165	Carotid retractor	168	DE BAKEY femur wound retractors	167
ALLISON lung spatulas, chest spatulas	158	CASTANEDA vascular clamps	188, 190	DE BAKEY forceps	30
ALM wound retractors	164	CASTANEDA cardio-thoracic retractor	178	DE BAKEY GLOVER aortic clamps	232
AMATO clamps	205	CASTROVIEJO micro steel needle holders	12	DE BAKEY GLOVER coarctation clamps	239
AMATO small derra clamps	205	Chest spatula	158	DE BAKEY GLOVER vascular clamps	216, 217, 239
Anastosis clamps	203, 253, 284	Chest tube forceps	286	DE BAKEY graspers PEN LINE	291
ANATOMIC micro titanium forceps	27	Chissel	182	DE BAKEY HARKEN Vascular clamps	231, 245
ANDREWS- PYCHON succer	297	CHITWOOD DE BAKEY clamp	289	DE BAKEY isolated forceps	48
Applying forceps	130, 131, 135, 137	Clamp construction	186	DE BAKEY KELLY vascular clamps	217
Applying forcep YASARGIL	316	Clamp jaw covers	315	DE BAKEY lung clamps	286
AORTA PUNCHES DOUBLE CUTTER	295	CLEVELAND vascular clamps	204	DE BAKEY multipurpose vascular clamps	191, 192
Aorta clamps	232, 234 - 238, 241	Clips	137, 138	DE BAKEY micro forceps	24
Aortic punches	312	Coarctation clamps	195, 226, 239	DE BAKEY MIXTER ligature clamp	224
Atraumatic steel vascular forceps	44, 45	Color coded system	315	DE BAKEY MIXTER dissecting forceps	274
Atraumatic jaws	187	COMBI-SPECIAL micro-forceps	25	DE BAKEY MOSQUITO vascular clamps	217
Atraumatic pat. ductus clamps	216	Container	311	DE BAKEY needle holders	16
Atraumatic vascular clamps	217 - 239	COOLEY anastomosis clamps	203	DE BAKEY partial occlusion clamps	202, 203
Atraumatic Titan vessel forceps	31, 32	COOLEY aortic clamps	236, 237	DE BAKEY patent ductus clamps	194
Auricle clamps	231	COOLEY atraumatic tissue forceps steel	44	DE BAKEY PEAN vascular clamps	218
AUSTIN Micro suture tying forceps	34	COOLEY bulldog clamps	207	DE BAKEY pediatric aorta clamp	196
<b>B</b>		COOLEY coarctation clamp	226	DE BAKEY RANKIN vascular clamps	217
BABY CRILE-WOOD needle holders	15	COOLEY DERRA Vascular clamps	226	DE BAKEY rib holders	180
BABY SENN-MILLER retractors	142	COOLEY flexible Vascular clamps	228	DE BAKEY SAPHENO-FEMORALIS junction clamps	
BABY-ADSON dissecting forceps	267	COOLEY ILLIAC Clamps	236		197
BABY-MIXTER dissecting forceps	267	COOLEY mitral-valve-hooks	169	DE BAKEY SATINSKY bulldog clamps	128
BABY-MIXTER haemostatic forceps	272	COOLEY multi purpose clamps	224	DE BAKEY SATINSKY vascular clamps	243
BABY-ROUX retractors	161	COOLEY patent ductus Vascular clamps	221	DE BAKEY SATINSKY vena cava clamp	245
BABY-SATINSKY anastomosis clamps	284	COOLEY SATINSKY Vascular clamps	244	DE BAKEY scissors	60
BACKHAUS clipse	248	COOLEY suction tube	297, 299	DE BAKEY SEMB aortic clamps	238
BACKHAUS towel forceps	248	COOLEY tangential occlusion clamps	237	DE BAKEY spoon pheripehral vascular clamp	
BAILEY rib holders	182	COOLEY Vascular clamps	208 - 233		195, 196
BAILEY rongeur	181	COOLEY Vascular clamps TITAN	212	DE BAKEY suction instruments	300
BAILY micro haemostatic- a. dissecting forceps	271	COOLEY vena cava clamps	252	DE BAKEY vascular clamps	
BAINBRIDGE DE BAKEY Vascular clamps	221	COOLEY-REMOLE RETRACTOR SET	172		189, 193, 194, 206, 219, 220, 242
BAJO needle holders	6	COOPER TITANIT scissors	73	DE BAKEY vascular forceps	31
Bandage scissor	74	COOPER-SLIM TITANIT scissors	74	DEAVER wound retractors and lung spatulas	
BECKMANN wound retractors	166	CORONAR SLIM-LINE haemostatic forceps	271		156, 157
BECKMANN-ADSON wound retractors	166	CRILE haemostatic forceps	257	DEBORAH-CASTANEDA partial occlusion clamps	
BENGOLA haemostatic forceps	259	CRILE needle holders	20		206
BERRY wire forceps	19	CRILE-RANKIN haemostatic forceps	258	DEBORAH-CASTANEDA peripheral vascular clamps	
BETHUNE rib shears	184	CRILE-WOOD needle holders	15		197
Bipolar coagulation forceps system	46	CROSS ACTION needle holders	6	DEBUS scissor	59
BITIP forceps	46, 47	CROSS instruments, Titan	26	Delicate needle holders	4
BONN delicate and fine scissors	75	CROSS OVERHOLT dissecting forceps	281	Delicate and fine scissors	75
BONN Titanit scissors	62	CUSHING anatomic forceps	38	Delicate and fine scissors SUPERCUT	92
BOZEMANN needle holders	18	CUSHING Power TC forceps	42	DERF needle holders	15
BRILLIANT micro steel forcep	316	CUSHING retractors	143, 144	DERRA partial occlusion clamps	199
Brilliant scissors	61	<b>D</b>		DERRA Vascular clamps TITAN	212
BROMTON tube miking roller	249	DARDIK Vascular clamps	215	DESMARRES retractors	140
Broncus clamps	282 - 285	DAVIDSON scapula retractor	158	Diamond knife	310
Bulldog clamps	125, 128 - 131	DE BAKEY anastomosis clamps	225	DIETHRICH aortic clamps	235
Bulldog clamps atraumatic	207, 213	DE BAKEY aortic clamps	236, 237, 241	DIETHRICH DE BAKEY Bulldog clamps	125
				Dissecting- and ligature forceps	276 - 280

# Index Artikelbeschreibung

## Index Item Description

	page		page		page
Dissecting forceps	267 - 281	<b>H</b>		KÖNIG retractors	140
Dissecting scissors	83 - 91	Haemostatic- and dissecting forceps	270 - 272	KRÖNLEIN tube miking roller	249
Dissecting scissors POWER TC	114 - 122	Haemostatic forceps	260 - 266		
Dissecting scissors SUPERCUT	99 - 107	HAGMÜLLER carotis retractor	168	<b>L</b>	
Dissector Titan	301	HAGMÜLLER wound retractors	168	LAHEY gall ductus forceps	272
Dissectors	301	HAJEK wire forceps	19	LAMBERT-KAY clamps Titan	212
Distale aortic clamps	247	HAJEK needle holders	18	LAMBERT-KEY COOLEY Aortic clamps	234
DOLPHIN suture organizer	251	HAJEK TITANIT scissors	70	Laminektomie and wound retractors	166
DOYEN towel forceps	248	HALSTED-FINO haemostatic forceps	272	LANGENBECK needle holders	20
Dressing forceps	35 - 38, 253	HARKEN vascular clamps	245	LANGENBECK retractors	146, 147
		HARRINGTON broncus clamps	282	LEBSCHKE sternal chisel	182
<b>E</b>		HARRINGTON retractors and lung spatulas	156	LEES broncus clamps	285
Eiselsberg TITANIT scissors	74	HEISS haemostatic forceps	259	LEITZ COOLEY partial occlusion clamps	210
ELEGANCE sure grip micro tying forceps	26	Heparin canula	310	LELAND-JONES DE BAKEY vascular clamps	220, 221
ELEGANCE CROSS-ACTION tying forceps	26	HOFFMANN Combi-PinStripper	304	LERICHE haemostatic forceps	257
Elegance needle holders	6	HOLLE haemostatic- and dissecting forceps	270, 273	Level trays	311
ENDO-needle holders	289			LEXER dissecting scissors	85
ERGONOMY needle holders	11	<b>I</b>		LEXER dissecting scissors POWER TC	114
EUPHRATE-PASQUE needle holders	13	I.M.A. Epicarteur	309	LEXER dissecting scissors SUPERCUT	101
		I.M.A. RETRACTOR	173, 174	LEXER TITANIT scissors	71
<b>F</b>		Identification Tape	315	Ligature clamps	224, 269, 276
FARABEUF retractors	162	ILLIACA clamps	236	Ligature clip-applicators for ethicon clips	131
Fine dissecting forceps	255	Instrument organizer	249	LILLEHEY POTTS dissecting scissors POWER TC	122
Fine haemostatic forceps	256 - 259	IN-SITU-BYPASS INSTRUMENT SET	316, 317	LILLEHEY POTTS dissecting scissors SUPERCUT	106
Fine TITANIT® dissecting scissors	65	Infraguener retractor	171	LILLEHEY-POTTS TITANIT dissecting scissors	66
Fine Titanit® scissors	62 - 642	Instrument guards	313	LINZ micro titan forceps	28
Fine retractors	141	Instrument organizer	248	LINZ micro forceps	33
Filiform tip	305	IORIO aorta dissecting clamps	270	LISTER Titanit Scissors	74
FINOCHIETTO BABY HAIGHT rib holders	177	IORIO haemostatic forceps	270	Long Titanit® Scissors	69
FINOCHIETTO retractor	175	IORIO suction instruments	298	Lung clamps	286
FINOCHIETTO infant rib holders	177	IORIO tube organizer	251	Lung spatula	155 - 158
FINOCHIETTO-BURFORD retractor	174	IRIS titanit scissors	62		
FINSEN wound retractors	164	Iris scissor	75	<b>M</b>	
FITZGERALD Aortic clamps	238	Iris scissor POWER TC	108	MARBERGER retractors	143
FLAT HANDLE needle holders	5	Iris scissor SUPERCUT	92	MATHIEU POWER TC needle holders	21
Flexible Vascular clamps	228	Irrigation- and suction canulas	296, 297	MATHIEU abdominal and intestinal spatulas	163
FOERSTER sponge holding forceps	254	Isolated forceps	48	MATHIEU needle holders	20
FOGART ATRAUMATIC "MULTI CHANGE"		ISRAEL retractors	145	MATHIEU-KOCHER needle holders	28
Vascular clamps	246			MATHIEU retractors	170
Forcep YASARGIL	316	<b>J</b>		MAYO FINO TITANIT scissors	71
		JACOBSEN vascular clamps	255	MAYO dissecting scissors SUPERCUT	100
<b>G</b>		JAMESON dissecting scissor	83	MAYO Instrument organizer	248
Gall ductus forceps	272	JAMESON-WERBER titanit scissors	64	MAYO Standard dissecting scissors	84
GARRET Vascular Dilators	294	JAVID vascular clamps	229	MAYO surgical scissors POWER TC	113
GELPI vulva-retractor	167	JOHNS HOPKINS applying forceps	130	Mayo TITANIT scissors	72
GELPI wound retractors	167	JOHNS HOPKINS bulldog clamps	130	MAYO-ADAMS wound retractors	288
GEMINI MINI dissecting- and ligature forceps	277	JONES towel forceps	248	MAYO-HEGAR needle holders	17
GEMINI dissecting- and ligature forceps	277	JOSEPH Titanit scissors	63	MAYO-LEXER dissecting scissors	85
GERALD DE BAKEY forceps	45			MAYO-LEXER dissecting scissors POWER TC	114
GERALD Micro Titan forceps	27	<b>K</b>		MAYO-LEXER dissecting scissors SUPERCUT	101
GERALD Micro forceps	25	KARMODY retractor	309, 316	MAYO-STILLE surgical scissors POWER TC	112
GERALD forceps	29	KELLY haemostatic forceps	257	MAYO-STILLE dissecting scissors	83
GIERTZ-STILLE rib shears	183	KELLY abdominal retractors	160	MAYO-STILLE dissecting scissors SUPERCUT	99
GILLIES surgical forceps	41	KERSTING abdominal anastomosis clamps	227	MAYO-STILLE TITANIT scissors	71
GLASGOW for Mammaria arteria	57	KILNER surgical scissors	82	MC INDOE tissue forceps	28, 41
GLOVER bulldog clamps	129	KILNER surgical scissors POWER TC	111	MEEKER dissecting- and ligature forceps	276
GOLF scissors	59	KILNER surgical scissors SUPERCUT	98	MERCEDES rib holders	180
GRAEFE anatomic forceps	35	KILNER TITANIT dissecting scissors	65	MERLO distale aortic clamps	247
GRAEFE surgical forceps	40	Knot pusher PEN LINE	291	Metal probe	305
GREGORY bulldog clamps	128	KOCHER haemostatic forceps	260	METZENBAUM-DELICATE TITANIT scissors	67
GREGORY profunda vascular clamps	214, 219	KOCHER retractors	150 - 154	METZENBAUM-FINO dissecting scissors POWER TC	118 - 119
GROSS dressing forceps	253	KOCHER- LANGENBECK retractors	148, 149	METZENBAUM-FINO dissecting scissors SUPERCUT	102, 103
GROSS-MAIER desing forceps	253	KOCHER-OCHSNER haemostatic forceps	265, 266		
GUNNAR-HEY tube miking roller	249	Combi-PinStripper	304		

	<i>page</i>		<i>page</i>		<i>page</i>
METZENBAUM-FINO standard dissecting scissors	86, 87	MOD. MILLS VALVULOTOME	308	<b>R</b>	
METZENBAUM FINO TITANIT scissors	68, 69	MORRIS aortic clamps	232	RAGNELI retractors	142
METZENBAUM LIGHT dissecting scissors SUPERCUT	106	MORSE sternal rib holders	178	RAGNELL-TUULA TITANIT dissecting scissors	65
METZENBAUM dissecting scissors POWER TC	120, 121	MUELLER Micro-Forceps	33	RAMPLEY sponge holding forceps	254
METZENBAUM dissecting scissors SUPERCUT	104, 105	Multi purpose clamps	224, 241, 242	RESANO CROSS-ACTION forceps	26
METZENBAUM MINI STRABISMUS		Multi purpose clamps for neonatal surgery	190	RESANO vascular forceps	45
TITANIT dissecting scissors	66	Multi purpose vascular clamps	191, 192	Retractors abdominal	159, 160
METZENBAUM STANDARD dissecting scissors	88, 89	MÜLLER clipse	138	REYNOLDS surgical scissors POWER TC	112
METZENBAUM TITANIT scissors	68, 69	<b>N</b>		REYNOLDS dissecting scissors	83
Metzenbaum ULTRA EXTREM TITANIT scissors	67	NABATOFF vein stripper set	305	REYNOLDS dissecting scissors SUPERCUT	99
METZENBAUM ULTRA FINO TITANIT scissors	67	Needle holders PEN LINE	290	REYNOLDS Titanit scissors	64
METZENBAUM ULTRA-FINO		Neonatal renal clamps	204	REYNOLDS-JAMESON surgical scissors	82
dissecting scissors POWER TC	115, 116	Nitinol applying forceps	135	RHOTON micro hook	317
METZENBAUM-S TITANIT scissors	70	Nitinol vessel probes	294	RHOTON retractors	139
Micro bulldog clamp DIETRICH	316	NOON vascular access tunneler	295	Rib holders	182
Micro-Bulldog clamps TITAN	127	<b>O</b>		Rib shears and sternal cutter	183
MICRO-CARDIO needle holders	10	OCHSNER aortic clamps	234	RICHARDSON retractors	154
MIC Instruments	292	OEHLER Power TC Forceps	43	Ring stripper	304
MIS Instruments	287, 288, 289	Olives	304, 305	Ringhandle scissors	59, 60
MICRO DELICATE Titan forceps	27	ONIX needle holders	10	Ringneedle holders, Titan and steel	13
MICRO-DELICATE needle holders	8	Osteotome Guards	313	Ringtip Micro forceps	24
MICRO-Dissector	301	OVERHOLT delicate dissecting forceps	279	ROBERTS haemostatic forceps	261
MICRO FINOCHIETTO retractor	176	OVERHOLT N. SUEMERMANN		ROCHESTER-PEAN haemostatic forceps	264
Micro forceps	33	dissecting forceps	281	Rongeur	181
Micro forceps, steel	30	OVERHOLT dissecting- and ligature forceps	276	ROUX retractors	161
Micro forceps, Titan	24	OVERHOLT SLIM LINE dissecting forceps	278	RÜHLAND suction tube	299
MICRO HALSTED-MOSQUITO forceps	256	OVERHOLT- GEISSENDOERFER		RUMEL-BELMONT Vascular-Instruments	303
MICRO JACOBSON vascular clamps	255	dissecting- and ligature forceps	280	RUSSIAN tissue forceps	39
MICRO KITZMILLER vascular clamps	211	OVERHOLT-S dissecting forceps	279	RYDER "FRENCH EYE" needle holders	17
MICRO needle holders, Titan	2 - 7	<b>P</b>		RYDER heedle holders	14
MICRO needle holders	8	Päivi for suture-fixation	302	<b>S</b>	
MICRO-OVERHOLT haemostatic- and		PARKER-LANGENBECK "US ARMY" retractors	161	Safety knife	310
dissecting forceps	271	Partial occlusion clamps	198 - 203, 210	SAFETY sterilization box	311
MICRO pediatric DE BAKEY vascular clamps	211	Patent doctus clamp	194	"SALZBURGER" spatula	301
Micro ringhandle scissors	58	PEACOCK micro steel scissors	56	SALZBURG TITANIT dissecting scissors	65
Micro scissor, flat handle	317	PEAN haemostatic forceps	260, 263	SALZBURG Titanit scissors	64
Micro scissors delicate	57	Pediatric and adult vascular clamps	193, 194	SAPHENO-FEMORALIS junction clamps	197
Micro scalpel handles	124	Pediatric aorta clamp	196	SAROT haemostatic forceps	262
MICRO SLIM LINE potts scissors	58	PEERS towel forceps	248	SAROT broncus clamps	282
Micro steel needle holders	9 - 11	PEN LINE	290, 291	SAROT needle holders	16
Micro steel forceps	29	PEN needle holders	7	SATINSKY anastomosis clamps	284
Micro steel scissors	51, 52	Peripheral vascular clamps	197, 215	SATINSKY dissecting scissors	91
Micro steel scissors, bajonett	56	Phlebologie Instruments	306, 307	SATINSKY dissecting scissors SUPERCUT	107
Micro suture tying forceps	34	PILZNER suction tube	299	SATINSKY "MOD. NEUHAUS" vascular clamps	240
MICRO SWAN scissors	50 - 54	Pin Stripper	304	SAUERBRUCH rib shears	183
Micro Titan forceps	27, 28	Plastic Titanit scissors	63	Scalpel handles	124
Micro-Titan needle holders	13	Plateau Micro-forceps	24	SCHMIEDEN-TAYLOR TITANIT Scissors	74
Micro TITANIT® scissors	55	Plateau forceps	30	SCHUHMACHER rib scissors	183
Micro tying forceps, Titan	25	POPLITEA retractor	171	SCHWARTZ applying forceps	130
Micro vascular needle holders	14	POTTS scissors	58	SCHWARTZ bulldog clamps	130
Micro retractors	139	POTTS-SMITH tissue forceps	39	Scissors JAMSON	317
MIDDELDORF retractors	153	POTTS-SMITH Power TC forceps	38, 42	Scissors PEN LINE	290
MIKULICZ abdominal retractor	159	POTTS-SMITH scissors	59	SEMB ligature clamp	269
Mini-bulldog clamps	126	POWER TC wire forceps	19	SEMKEN anatomic forceps	35
MINI-LANGENBECK retractors	140	POWER TC needle holders	14 - 21	SEMKEN tissue forceps	40
MIS Instruments	287 - 289	POWER TC forceps	42, 43	SEMKEN Power TC forceps	42
Mitral valve retractor	170	PRICE-THOMAS broncus clamps	283	SENN-GREEN retractors	142
Mitral valve hooks	169	PROVIDENCE-HOSPITAL haemostatic forceps	256	SENN-MILLER retractors	142
MIXTER dissecting forceps	268, 275	Punches	295	SHUNT Flexible vascular clamps	228
MOBERG retractors	139	PYRAMID vascular clamps	255	SIMS TITANIT scissors	72
				Single use products	312, 314, 315
				SLIM LINE POTTS scissors	58
				SLIM LINE SWAN scissors	50 - 54
				SMOOTH Micro tying forceps	25

# Index Artikelbeschreibung

## Index Item Description

	page		page
Soft cover	159, 160	<b>U</b>	
Softgrip micro bulldog clamps	126	ULRICH dressing forceps	253
Spatula	301	<b>V</b>	
SPENCER-WELLS haemostatic forceps	260	Valve retractor FPR DIE MINI Thoracotomy	292
Sponge holding forceps	253, 254	Valvulotome LEATHER	317
Spoon pheripehrle vascular clamps	195, 196	VALVULOTOMY INSTRUMENTS	308
Standard anatomic forceps	36	Valvulotomy scissors	308, 317
Standard Micro steel scissors	52	VARADY Phlebologie Instruments	306, 307
Standard Micro TITANIT scissors	55	Vascu-loops	314
Standard surgical scissors	76 - 81	Vascular access tunneler	295
Standard surgical scissors POWER TC	108 - 110	Vascular clamps	224 - 246
Standard surgical scissors SUPERCUT	93 - 97	Vascular clamps atraumatic	214 - 216, 219
Standard tissue forceps	37, 40, 41	Vascular clamps f. renal	227
Sterilization Box	311	Vascular clamps f. pediatric surgery	206 - 210
STERNAL RETRACTOR	173	Vascular clamps f.tangential occlusion	242
Sternal chissel	182	Vascular clamps TITAN	211, 212
Sternal cutter	183	Vascular clips	138
Sternum retractor for Mamaria Arterie	173	Vascular scissor DE BAKEY	60
STEVENS surgical scissors	82	Vascular suction instruments	297
STEVENS surgical scissors POWER TC	111	Vein retractors	140
STEVENS surgical scissors SUPERCUT	98	Vena Cava clamps	245, 252
STEVENS Titanit scissors	62, 64	Vessel scissors	90
STRANDELL-STILLE retractors	144	Vessel suction tube	281
STRELI haemostatic- and dissecting forceps	270	VIGANO Vascular clamps	239
Stripper	303, 304	VIGANO vascular suction tube	289
Struma surgery	273	VIGANO suction instruments	300
Suction instruments	298 -300	WISE Micro suture tying forceps	34
Suction tube	296, 299	VOLKMANN retractors	144
Surgical scissors	76 - 82	<b>W</b>	
Surgical scissors POWER TC	108 - 113	WAHL Micro Titan forceps	27
Surgical scissors SUPERCUT	93 - 98	WAUGH tissue forceps	39
Suture clamp tags	314	WEBER aortic clamps	235
Suture instruments	139	WEBSTER needle holders	15
<b>T</b>		WEITLANER wound retractors	164
Tangential occlusion clamps	198 - 203, 235	WILMER delicate and fine scissors	75
TAYLOR anatomic forceps	38	Wound- and vein retractors	140, 143, 144
TAYLOR tissue forceps	39	Wound retractor cover	159, 160
TEALDI vascular clamps	190, 229	Wound retractors	164 - 168
Thoracic trocars	287	WYLIE hypogastrik clamps	223
THOREK dissecting scissors	91	<b>Y</b>	
TIGER needle holders	7	YANKAUER suction instruments	300
Tissue forceps	39 - 41	YASARGIL aneurysma Clipse	132 - 136
Titanit® dissecting scissors	66	YASARGIL applying forceps	135
TITAN FINOCHIETTO retractor	176	YASARGIL irrigation canulas	296
TITAN forceps	316	<b>Z</b>	
TITANIT® Metzzenbaum scissors	67, 68	ZENKER haemostatic forceps	262
TITAN Micro-needle holders,	316	ZENKER retractors	151
Titanit® Scissors	53 - 55, 58 - 74	ZWEIFEL needle holders	21
TOENNIS haemostatic forceps	261		
TÖNNIS-ADSON dissecting scissors	90		
TOENNIS-ADSON TITANIT dissecting scissors	66		
TÖNNIS-ADSON dissecting scissors POWER TC	122		
TÖNNIS-ADSON dissecting scissors SUPERCUT	106		
TOPAS CASTROVIEJO Micro needle holders	317		
TOPAS needle holders	12		
Trocars	287		
Towel forceps	248		
Tube miking roller	249 - 251		
Tunneling instruments	303		
Tunneling scissors	90		
TUULA PANKREAS TITANIT dissecting scissors	65		
TUULU dissecting forceps	275		

### ATTENTION

All surgical instruments may be used only in accordance with its purpose. For example delicate scissors may be not used to cut hard materials like calcium deposits or plaque etc.. If a user is not sure for handling Asanus surgical instruments he has to ask Asanus for the correct usage. In case of wrong handling of the Asanus surgical products Asanus cannot take any warranty.

	Seite page		Seite page		Seite page		Seite page		Seite page
<b>A</b>		<b>DSP</b>		<b>G</b>		<b>GF</b>		<b>GF</b>	
AU 0359.....	140	DSP 007.....	314	GF 0002.....	125	GF 0303.....	304	GF 0766-1.....	45
AU 0360.....	140	DSP 008.....	314	GF 0003.....	125	GF 0304.....	304	GF 0767.....	45
AU 0361.....	140	DSP 009.....	314	GF 0004.....	125	GF 0305.....	304	GF 0770.....	44
AU 0362.....	140	DSP 010.....	314	GF 0005.....	125	GF 0341.....	306	GF 0776.....	44
AU 0370.....	140	DSP 011.....	314	GF 0006.....	125	GF 0342.....	306	GF 0778.....	44
AU 0371.....	140	DSP 012.....	314	GF 0007.....	125	GF 0343.....	306	GF 0780.....	44
AU 0380.....	140	DSP 013.....	314	GF 0009.....	125	GF 0350.....	306	GF 0790.....	44
AU 0381.....	140	DSP 014.....	314	GF 0009.....	125	GF 0360.....	306	GF 0792.....	44
AU 0390.....	140	DSP 015.....	314	GF 0011.....	125	GF 0361.....	307	GF 0794.....	44
AU 0391.....	140	DSP 016.....	314	GF 0012.....	125	GF 0370.....	307	GF 0796.....	44
AU 0400.....	140	DSP 020.....	315	GF 0012S.....	125	GF 0380.....	307	GF 0798.....	44
AU 0401.....	140	DSP 021.....	315	GF 0013.....	125	GF 0390.....	307	GF 0799.....	44
AU 1028.....	35	DSP 022.....	315	GF 0013S.....	25	GF 0400.....	307	GF 0800.....	44
AU 1029.....	35	DSP 070.....	315	GF 0014.....	125	GF 0409.....	301	GF 0810.....	44
AU 1030.....	35	DSP 071.....	315	GF 0014S.....	125	GF 0609.....	295	GF 0821.....	44
AU 1031.....	35	DSP 072.....	315	GF 0015.....	125	GF 0610.....	295	GF 0825.....	45
AU 1032.....	35	DSP 073.....	315	GF 0015S.....	125	GF 0614.....	295	GF 0826.....	45
AU 1033.....	35	DSP 074.....	315	GF 0016.....	125	GF 0615.....	295	GF 0829.....	44
AU 1034.....	35	DSP 075.....	315	GF 0016S.....	125	GF 0616.....	295	GF 0830.....	44
AU 1035.....	35	DSP 076.....	315	GF 0017.....	125	GF 0617.....	295	GF 0831.....	44
AU 1036.....	35	DSP 077.....	315	GF 0017S.....	125	GF 0618.....	295	GF 0840.....	44
AU 1040.....	40	DSP 078.....	315	GF 0018.....	316	GF 0620.....	295	GF 0844.....	44
AU 1041.....	40	DSP 079.....	315	GF 0019.....	126	GF 0621.....	295	GF 0848.....	44
AU 1042.....	40	DSP 080.....	315	GF 0019T.....	126	GF 0622.....	295	GF 0850.....	44
AU 1050.....	40	DSP 081.....	315	GF 0020.....	126	GF 0623.....	295	GF 0851.....	44
AU 1051.....	40	DSP 082.....	315	GF 0020T.....	126	GF 0624.....	295	GF 0852.....	44
AU 1052.....	40	DSP 083.....	315	GF 0021.....	126	GF 0625.....	295	GF 0853.....	44
AU 1060.....	40	DSP 084.....	315	GF 0021T.....	126	GF 0645.....	130	GF 0854.....	44
AU 1061.....	40	DSP 085.....	315	GF 0022.....	126	GF 0646.....	130	GF 0860.....	44
AU 1062.....	40	DSP 086.....	315	GF 0022T.....	126	GF 0647.....	130	GF 0870.....	44
AU 1511.....	57	DSP 087.....	315	GF 0023.....	126	GF 0648.....	130	GF 0872.....	44
AU 1580.....	75	DSP 088.....	315	GF 0023T.....	126	GF 0651.....	126	GF 0874.....	44
AU 1581.....	75	DSP 089.....	315	GF 0024.....	126	GF 0652.....	126	GF 0876.....	44
AU 8000-1.....	310	DSP 101.....	313	GF 0024T.....	126	GF 0653.....	126	GF 0878.....	44
AU 8000-2.....	310	DSP 102.....	313	GF 0030T.....	126	GF 0654.....	126	GF 0880.....	44
		DSP 103.....	313	GF 0100.....	305	GF 0655.....	126	GF 0882.....	44
		DSP 104.....	313	GF 0111.....	305	GF 0656.....	126	GF 0884.....	44
		DSP 105.....	313	GF 0112.....	304, 305	GF 0690.....	128	GF 0886.....	44
		DSP 106.....	313	GF 0114.....	304, 305	GF 0700.....	128	GF 0888.....	44
		DSP 107.....	313	GF 0115.....	304, 305	GF 0701.....	127	GF 0889.....	44
		DSP 108.....	313	GF 0116.....	304, 305	GF 0702.....	127	GF 0890.....	129
		DSP 121.....	313	GF 0117.....	304, 305	GF 0703.....	127	GF 0891.....	44
		DSP 122.....	313	GF 0118.....	304, 305	GF 0704.....	127	GF 0897.....	128
		DSP 123.....	313	GF 0119.....	305	GF 0710.....	128	GF 0898.....	128
		DSP 124.....	313	GF 0190.....	305	GF 0711.....	127	GF 0899.....	44
		DSP 125.....	313	GF 0241.....	294	GF 0712.....	127	GF 0900.....	129
		DSP 126.....	313	GF 0242.....	294	GF 0713.....	127	GF 0904.....	126
		DSP 127.....	313	GF 0243.....	294	GF 0714.....	127	GF 0905.....	126
		DSP 128.....	313	GF 0244.....	294	GF 0720.....	128	GF 0906.....	126
		DSP 129.....	313	GF 0245.....	294	GF 0731.....	127	GF 0910.....	129
		DSP 130.....	313	GF 0246.....	294	GF 0732.....	127	GF 0913.....	125
				GF 0247.....	294	GF 0733.....	127	GF 0920.....	129
		<b>E</b>		GF 0248.....	294	GF 0734.....	127	GF 0930.....	129
		EN 2501.....	289	GF 0249.....	294	GF 0740.....	44	GF 0940.....	129
		EN 7400.....	290	GF 0265.....	295	GF 0741.....	127	GF 0950.....	129
		EN 7401.....	290	GF 0270.....	304	GF 0742.....	127	GF 0960.....	129
		EN 7402.....	290	GF 0271.....	304	GF 0743.....	127	GF 0970.....	128
		EN 7410.....	290	GF 0272.....	304	GF 0744.....	127	GF 0975.....	129
		EN 7413.....	290	GF 0273.....	304	GF 0747.....	127	GF 0980.....	129
		EN 7420.....	290	GF 0274.....	304	GF 0749.....	127	GF 0985.....	129
		EN 7421.....	290	GF 0275.....	304	GF 0750.....	44	GF 0990.....	129
		EN 7422.....	290	GF 0276.....	304	GF 0752.....	127	GF 1000.....	129
		EN 7426.....	290	GF 0277.....	304	GF 0753.....	127	GF 1010.....	129
		EN 7430.....	291	GF 0294.....	317	GF 0754.....	127	GF 1020.....	129
		EN 7431.....	291	GF 0295.....	308	GF 0757.....	44	GF 1024G.....	189
		EN 7432.....	291	GF 0297.....	308	GF 0759.....	44	GF 1024S.....	189
		EN 7434.....	291	GF 0298.....	308	GF 0760.....	44	GF 1026G.....	189
		EN 7435.....	291	GF 0299.....	317	GF 0762.....	127	GF 1026S.....	189
		EN 7440.....	291	GF 0300.....	304	GF 0763.....	127	GF 1028G.....	189
				GF 0301.....	304	GF 0764.....	127	GF 1028S.....	189
				GF 0302.....	304	GF 0765.....	45	GF 1029G.....	189
								GF 1029S.....	189
								GF 1030.....	129
								GF 1031G.....	189
								GF 1031S.....	189
								GF 1032G.....	189
								GF 1032S.....	189
								GF 1033G.....	189
								GF 1033S.....	189
								GF 1034G.....	189
								GF 1034S.....	189
								GF 1035G.....	189
								GF 1035S.....	189
								GF 1036G.....	189
								GF 1036S.....	189
								GF 1037G.....	189
								GF 1037S.....	189
								GF 1038G.....	189
								GF 1038S.....	189
								GF 1039G.....	189
								GF 1039S.....	189
								GF 1040.....	217
								GF 1041.....	217
								GF 1042.....	217
								GF 1043.....	217
								GF 1044.....	217
								GF 1045.....	217
								GF 1048.....	218
								GF 1049.....	218
								GF 1052.....	218
								GF 1053.....	218
								GF 1054G.....	189
								GF 1054S.....	189
								GF 1055G.....	189
								GF 1055S.....	189
								GF 1056G.....	189
								GF 1056S.....	189
								GF 1057G.....	189
								GF 1057S.....	189
								GF 1058G.....	189
								GF 1058S.....	189
								GF 1062.....	190
								GF 1100.....	221
								GF 1101.....	221
								GF 1102.....	221
								GF 1103.....	221
								GF 1114.....	241
								GF 1115.....	241
								GF 1132.....	228
								GF 1134.....	228
								GF 1136.....	228
								GF 1140.....	216
								GF 1141.....	216
								GF 1152.....	228
								GF 1154.....	228
								GF 1156.....	228
								GF 1160.....	220
								GF 1161.....	220
								GF 1162.....	220
								GF 1163.....	220
								GF 1164.....	239
								GF 1165.....	239
								GF 1166.....	



# Index Artikelnummern

## Index Item Numbers

	Seite page		Seite page		Seite page		Seite page		Seite page		
GF 1280.....	219	GF 1940.....	213	GF 2185.....	202	GF 2720.....	226	GF 3208K.....	170	GF 5080.....	310
GF 1290.....	219	GF 1942.....	213	GF 2186.....	202	GF 2730.....	226	GF 3210.....	179	GF 5091.....	294
GF 1291.....	188	GF 1949.....	213	GF 2187.....	203	GF 2740.....	226	GF 3220.....	179	GF 5091-1.....	294
GF 1292.....	188	GF 1970.....	213	GF 2188.....	203	GF 2760.....	210	GF 3230.....	179	GF 5091-3.....	294
GF 1293.....	188	GF 1972.....	229	GF 2191.....	203	GF 2761.....	209	GF 3240.....	179	GF 5092.....	294
GF 1300.....	220	GF 1980.....	213	GF 2192.....	204	GF 2770.....	208	GF 3244.....	174	GF 5093.....	294
GF 1319.....	221	GF 2040.....	225	GF 2193.....	204	GF 2780.....	208	GF 3245.....	173	GF 6040.....	303
GF 1320.....	221	GF 2041.....	225	GF 2194.....	205	GF 2820.....	230	GF 3245-1.....	173	GF 6041.....	303
GF 1330.....	221	GF 2042.....	225	GF 2195.....	205	GF 2830.....	230	GF 3245-2.....	173	GF 6042.....	303
GF 1350.....	236	GF 2050.....	225	GF 2211.....	214	GF 2860.....	208	GF 3246.....	173	GF 6528.....	312
GF 1360.....	236	GF 2051.....	225	GF 2212.....	214	GF 2870.....	207	GF 3247.....	173	GF 6536.....	312
GF 1370.....	236	GF 2052.....	225	GF 2213.....	214	GF 2880.....	208	GF 3248.....	173	GF 6540.....	312
GF 1382.....	247	GF 2060.....	225	GF 2214.....	214	GF 2881.....	208	GF 3249.....	173	GF 6544.....	312
GF 1390.....	237	GF 2061.....	225	GF 2215.....	219	GF 2900.....	216	GF 3250.....	180	GF 6548.....	312
GF 1400.....	237	GF 2062.....	225	GF 2216.....	219	GF 2910.....	216	GF 3256.....	172	GF 6552.....	312
GF 1420.....	236	GF 2069.....	206	GF 2250.....	284	GF 2920.....	216	GF 3290.....	175	GF 6556.....	312
GF 1421.....	236	GF 2070.....	225	GF 2259.....	284	GF 2922.....	224	GF 3290A.....	175	GF 6560.....	312
GF 1430.....	237	GF 2080.....	206	GF 2260.....	284	GF 2923.....	224	GF 3330.....	182	GF 6628.....	312
GF 1439.....	238	GF 2090.....	206	GF 2270.....	284	GF 2930.....	238	GF 3334.....	171	GF 6636.....	312
GF 1440.....	238	GF 2100.....	206	GF 2280.....	284	GF 2933.....	237	GF 3340.....	182	GF 6640.....	312
GF 1460.....	222	GF 2101.....	191	GF 2309.....	188	GF 2935.....	237	GF 3350.....	182	GF 6644.....	312
GF 1461.....	222	GF 2102.....	191	GF 2311.....	188	GF 2950.....	236	GF 3360.....	178	GF 6648.....	312
GF 1470.....	222	GF 2103.....	191	GF 2312.....	188	GF 2951.....	233	GF 3370.....	178	GF 6652.....	312
GF 1470-1.....	222	GF 2105.....	316	GF 2313.....	188	GF 2955.....	221	GF 3380.....	179	GF 6656.....	312
GF 1470-2.....	222	GF 2111.....	192	GF 2320.....	245	GF 2956.....	233	GF 3380A.....	179	GF 6660.....	312
GF 1470-3.....	222	GF 2112.....	192	GF 2350.....	303	GF 2958.....	233	GF 3381.....	172, 179	GF 8000.....	24
GF 1471.....	222	GF 2113.....	192	GF 2351.....	302	GF 2959.....	233	GF 3392A.....	178	GF 8001.....	24
GF 1495.....	223	GF 2114.....	192	GF 2354.....	302	GF 2960.....	236	GF 3393A.....	178	GF 8002.....	24
GF 1496.....	223	GF 2115.....	192	GF 2356.....	302	GF 2961.....	233	GF 3394A.....	178	GF 8003.....	24
GF 1500.....	235	GF 2130.....	285	GF 2357.....	302	GF 2962.....	233	GF 3407.....	177	GF 8004.....	24
GF 1510.....	235	GF 2139.....	193	GF 2360.....	303	GF 2970.....	235	GF 3470-1.....	177	GF 8005.....	24
GF 1520.....	234	GF 2141.....	193	GF 2370.....	303	GF 2971.....	235	GF 3480.....	169	GF 8009.....	25
GF 1540.....	234	GF 2142.....	193	GF 2400.....	246	GF 2972.....	236	GF 3490.....	169	GF 8010.....	24
GF 1541.....	234	GF 2143.....	193	GF 2440.....	246	GF 3000.....	244	GF 3493.....	169	GF 8011.....	24
GF 1550.....	232	GF 2144.....	193	GF 2442.....	246	GF 3010.....	244	GF 3494.....	169	GF 8012.....	24
GF 1551.....	232	GF 2145.....	194	GF 2480.....	246	GF 3020.....	244	GF 3495.....	169	GF 8013.....	24
GF 1570.....	234	GF 2146.....	194	GF 2481.....	246	GF 3030.....	244	GF 3500.....	169	GF 8014.....	26
GF 1570-1.....	234	GF 2147.....	194	GF 2482.....	246	GF 3040.....	244	GF 3550.....	184	GF 8015.....	26
GF 1571.....	234	GF 2148.....	194	GF 2500.....	207	GF 3048.....	169	GF 3570.....	183	GF 8016.....	24
GF 1589.....	224	GF 2149.....	194	GF 2501.....	239	GF 3050.....	210	GF 3580.....	183	GF 8017.....	27
GF 1590.....	224	GF 2151.....	195	GF 2502.....	239	GF 3070.....	175	GF 3600.....	183	GF 8018.....	24
GF 1620.....	245	GF 2152.....	195	GF 2514.....	249	GF 3070A.....	175	GF 3620.....	183	GF 8019.....	24
GF 1630.....	245	GF 2153.....	195	GF 2525.....	249	GF 3080.....	175	GF 3630.....	182	GF 8020.....	24
GF 1640.....	245	GF 2154.....	195	GF 2526.....	249	GF 3080A.....	175	GF 3675.....	286	GF 8021.....	24
GF 1660.....	243	GF 2155.....	195	GF 2530.....	207	GF 3090.....	175	GF 3687.....	282	GF 8022.....	24
GF 1670.....	243	GF 2156.....	196	GF 2540.....	207	GF 3090A.....	175	GF 3689.....	282	GF 8023.....	24
GF 1671.....	243	GF 2157.....	196	GF 2550.....	208	GF 3100.....	174	GF 3690.....	283	GF 8024.....	24
GF 1672.....	243	GF 2158.....	196	GF 2580.....	207	GF 3101.....	175	GF 3700.....	283	GF 8025.....	24
GF 1673.....	243	GF 2161.....	197	GF 2590.....	209	GF 3102.....	175	GF 3710.....	283	GF 8026.....	25
GF 1682.....	240	GF 2162.....	197	GF 2600.....	208	GF 3103.....	175	GF 3721.....	282	GF 8027.....	25
GF 1692.....	240	GF 2163.....	197	GF 2610.....	218, 226	GF 3121.....	292	GF 3722.....	282	GF 8028.....	25
GF 1709.....	241	GF 2164.....	197	GF 2615.....	218	GF 3122.....	292	GF 3730.....	283	GF 8029.....	24
GF 1710.....	241	GF 2165.....	197	GF 2620.....	226	GF 3123.....	292	GF 3770.....	269	GF 8030.....	24, 316
GF 1711.....	241	GF 2166.....	198	GF 2622.....	252	GF 3130.....	180	GF 3780.....	269	GF 8031.....	27
GF 1712.....	241	GF 2167.....	198	GF 2623.....	252	GF 3150.....	180	GF 3940.....	177	GF 8032.....	27
GF 1740.....	242	GF 2168.....	198	GF 2624.....	252	GF 3160.....	180	GF 3940S.....	177	GF 8035.....	25
GF 1741.....	242	GF 2169.....	198	GF 2630.....	226	GF 3170.....	180	GF 3950.....	177	GF 8036.....	25
GF 1742.....	242	GF 2170.....	199	GF 2631.....	252	GF 3190.....	179	GF 3950S.....	177	GF 8037.....	25
GF 1744.....	242	GF 2171.....	199	GF 2632.....	252	GF 3202-01.....	172	GF 3990.....	215	GF 8038.....	25
GF 1780.....	242	GF 2172.....	200	GF 2633.....	252	GF 3202-02.....	172	GF 4030.....	215	GF 8044.....	24
GF 1783.....	242	GF 2173.....	200	GF 2634.....	252	GF 3202-04.....	172	GF 4040.....	215	GF 8046.....	24
GF 1800.....	231, 245	GF 2174.....	200	GF 2635.....	252	GF 3208-1.....	170	GF 4080.....	215	GF 8047.....	24
GF 1840.....	235	GF 2175.....	200	GF 2636.....	252	GF 3208-10.....	170	GF 4443.....	228	GF 8048.....	24
GF 1850.....	218	GF 2176.....	200	GF 2637.....	252	GF 3208-2.....	170	GF 4445.....	228	GF 8049.....	24
GF 1860.....	218	GF 2177.....	201	GF 2658.....	190, 229	GF 3208-3.....	170	GF 4447.....	228	GF 8050.....	24
GF 1900.....	218	GF 2178.....	201	GF 2659.....	190, 229	GF 3208-4.....	170	GF 4449.....	228		
GF 1906.....	229	GF 2179.....	201	GF 2660.....	209	GF 3208-5.....	170	GF 4901.....	301		
GF 1907.....	229	GF 2181.....	201	GF 2670.....	209	GF 3208-6.....	170	GF 4902.....	301		
GF 1911.....	218	GF 2182.....	201	GF 2680.....	209	GF 3208-7.....	170	GF 5076.....	310		
GF 1920.....	218	GF 2183.....	202	GF 2690.....	209	GF 3208-8.....	170	GF 5077.....	310		
GF 1930.....	218	GF 2184.....	202	GF 2700.....	209	GF 3208-9.....	170	GF 5078.....	310		

	Seite page		Seite page		Seite page		Seite page		Seite page		
GF 8051.....	24	GF 8770.....	32	GFB 6521.....	30	KL 0101.....	271	KL 2215K.....	255	KL 2771.....	262
GF 8058.....	28	GF 8778.....	32	GFB 6523.....	30	KL 0101-1.....	271	KL 2216.....	255	KL 2830.....	262
GF 8060.....	24	GF 8780.....	32	GFB 6525.....	30	KL 0102.....	271	KL 2217.....	255	KL 2838.....	259
GF 8071.....	24	GF 8781.....	32	GFB 6618.....	30	KL 0102-1.....	271	KL 2222.....	256	KL 2839.....	259
GF 8080.....	24	GF 8782.....	32	GFB 6621.....	30	KL 0180.....	253	KL 2223.....	256	KL 2840.....	259
GF 8090.....	31	GF 8785.....	32	GFB 5121-1.....	30	KL 0190.....	253	KL 2224.....	255	KL 2841.....	259
GF 8091.....	31	GF 8787.....	32	GFK 8017.....	211	KL 0200.....	253	KL 2225.....	255	KL 2888.....	259
GF 8092.....	31	GF 8788.....	32	GFK 8018.....	211	KL 0210.....	253	KL 2230.....	256	KL 2889.....	259
GF 8092-1.....	31	GF 8790.....	32	GFK 8019.....	211	KL 0220.....	253	KL 2231.....	256	KL 2890.....	259
GF 8093.....	31	GF 8791.....	32	GFK 8020.....	211	KL 0230.....	253	KL 2233.....	255	KL 2891.....	259
GF 8095.....	31	GF 8792.....	32	GFK 8021.....	211	KL 0240.....	253	KL 2242.....	270	KL 2920.....	260
GF 8098.....	31	GF 8793.....	32	GFK 8022.....	211	KL 0250.....	253	KL 2243.....	270	KL 2921.....	260
GF 8100.....	24	GF 8794.....	32	GFK 8051.....	212	KL 0260.....	253	KL 2270.....	256	KL 2940.....	260
GF 8101.....	24	GF 8800.....	32	GFK 8052.....	212	KL 0270.....	253	KL 2271.....	256	KL 2941.....	260
GF 8101-1.....	24	GF 8810.....	32	GFK 8053.....	212	KL 0280.....	253	KL 2288.....	256	KL 2960.....	260
GF 8102.....	24	GF 8820.....	32	GFK 8054.....	212	KL 0285.....	253	KL 2289.....	256	KL 2961.....	260
GF 8103.....	24	GF 8824.....	32	GFK 8055.....	212	KL 0290.....	253	KL 2290.....	256	KL 2980.....	260
GF 8104.....	24	GF 8830.....	32	GFK 8056.....	212	KL 0300.....	253	KL 2291.....	256	KL 2981.....	260
GF 8105.....	24	GF 8832.....	32	GFK 8091.....	211	KL 0310.....	253	KL 2296.....	255	KL 2991.....	260
GF 8110.....	24	GF 8835.....	32	GFK 8092.....	211	KL 0320.....	253	KL 2297.....	255	KL 3030.....	260
GF 8111.....	24	GF 8890.....	27			KL 0330.....	253	KL 2310.....	256	KL 3031.....	260
GF 8112.....	24	GF 8892.....	27	<b>H</b>		KL 0410.....	254	KL 2311.....	256	KL 3078.....	264
GF 8113.....	24	GF 8900.....	301	HA 2070.....	300	KL 0415.....	254	KL 2330.....	257	KL 3079.....	263
GF 8119.....	24	GF 8905.....	301			KL 0416.....	254	KL 2331.....	257	KL 3080.....	264
GF 8120.....	24	GF 8907.....	301	HBS 0040.....	160	KL 0420.....	254	KL 2345.....	289	KL 3081.....	263
GF 8121.....	24	GF 8908.....	301	HBS 0060.....	160	KL 0430.....	254	KL 2346.....	289	KL 3081K.....	263
GF 8123.....	24			HBS 0065.....	160	KL 0440.....	254	KL 2347.....	289	KL 3082.....	264
GF 8129.....	26	GFB 4318.....	29	HBS 0100.....	160	KL 0470.....	254	KL 2390.....	257	KL 3083.....	263
GF 8130.....	26	GFB 4321.....	29	HBS 0150.....	160	KL 0480.....	254	KL 2391.....	257	KL 3084.....	264
GF 8131.....	26	GFB 4323.....	29	HBS 0200.....	160	KL 0670.....	248	KL 2430.....	257	KL 3085.....	263
GF 8146.....	24	GFB 4418.....	29	HBS 0210.....	160	KL 0720.....	248	KL 2431.....	257	KL 3086.....	264
GF 8147.....	24	GFB 4421.....	29	HBS 0300.....	160	KL 0740.....	248	KL 2450.....	257	KL 3087.....	263
GF 8148.....	24	GFB 4423.....	29	HBS 0350.....	160	KL 0741.....	251	KL 2451.....	257	KL 3088.....	264
GF 8148-1.....	25	GFB 4518.....	29	HBS 0400.....	160	KL 0742.....	251	KL 2490.....	258	KL 3089.....	263
GF 8149.....	24	GFB 4521.....	29			KL 0743.....	251	KL 2491.....	258	KL 3090.....	264
GF 8150.....	24	GFB 4523.....	29	<b>K</b>		KL 0750.....	248	KL 2520.....	257	KL 3091.....	263
GF 8150-1.....	25	GFB 5115.....	30	KG 0120.....	47	KL 0760.....	248	KL 2521.....	257	KL 3092.....	264
GF 8151.....	24	GFB 5118.....	30	KG 0120B.....	47	KL 0762.....	248	KL 2581.....	273	KL 3093.....	263
GF 8152.....	24	GFB 5121.....	30	KG 0122.....	47	KL 0780.....	248	KL 2582.....	273	KL 3094.....	264
GF 8152-1.....	25	GFB 5123.....	30	KG 0122B.....	47	KL 0810.....	248	KL 2583.....	273	KL 3095.....	263
GF 8153.....	24	GFB 5125.....	30	KG 0124.....	47	KL 0878.....	248	KL 2591.....	276	KL 3260.....	260
GF 8154.....	24	GFB 5315.....	30	KG 0124B.....	47	KL 0879.....	248	KL 2592.....	276	KL 3261.....	260
GF 8154-1.....	25	GFB 5315-1.....	30	KG 0126.....	47	KL 0880.....	248	KL 2593.....	270	KL 3262.....	260
GF 8158.....	26	GFB 5318.....	30	KG 0126B.....	47	KL 0908.....	248	KL 2594.....	270	KL 3263.....	260
GF 8160.....	26	GFB 5318-1.....	30	KG 0128.....	47	KL 0910.....	248	KL 2600.....	258	KL 3318.....	266
GF 8170.....	28	GFB 5321.....	30	KG 0128B.....	47	KL 0911.....	248	KL 2601.....	258	KL 3319.....	265
GF 8175.....	28	GFB 5321-1.....	30	KG 0130.....	47	KL 0920.....	248	KL 2602.....	271	KL 3320.....	266
GF 8189.....	27	GFB 5323.....	30	KG 0130B.....	47	KL 2000.....	130	KL 2604.....	271	KL 3320K.....	266
GF 8190.....	27	GFB 5323-1.....	30	KG 0140.....	47	KL 2010.....	130	KL 2607.....	271	KL 3321.....	265
GF 8191.....	25	GFB 5325.....	30	KG 0142.....	47	KL 2020.....	130	KL 2609.....	258	KL 3322.....	266
GF 8196.....	27	GFB 5325-1.....	30	KG 0143.....	47	KL 2030.....	130	KL 2620.....	256	KL 3323.....	265
GF 8400.....	212	GFB 5518.....	30	KG 0144.....	47	KL 2040.....	130	KL 2621.....	256	KL 3324.....	266
GF 8410.....	129	GFB 5521.....	30	KG 0145.....	47	KL 2050.....	130	KL 2623.....	272	KL 3325.....	265
GF 8411.....	129	GFB 5523.....	30	KG 0147.....	46	KL 2060.....	130	KL 2640.....	259	KL 3326.....	266
GF 8412.....	129	GFB 5525.....	30	KG 0148.....	47	KL 2070.....	130	KL 2641.....	259	KL 3327.....	265
GF 8413.....	129	GFB 6215.....	30	KG 0148S.....	47	KL 2186.....	256	KL 2643.....	259	KL 3328.....	266
GF 8414.....	129	GFB 6215-1.....	30	KG 0150.....	46	KL 2187.....	256	KL 2690.....	256	KL 3329.....	265
GF 8415.....	129	GFB 6218.....	30	KG 0151.....	47	KL 2202.....	255	KL 2700.....	256	KL 3330.....	266
GF 8416.....	129	GFB 6218-1.....	30	KG 0151S.....	47	KL 2203.....	255	KL 2710.....	256	KL 3331.....	265
GF 8610.....	126	GFB 6221.....	30	KG 0152.....	46	KL 2204.....	255	KL 2711.....	256	KL 3332.....	266
GF 8739.....	32	GFB 6221-1.....	30	KG 0153.....	47	KL 2205.....	255	KL 2730.....	259	KL 3335.....	265
GF 8740.....	32	GFB 6223.....	30	KG 0153S.....	47	KL 2206.....	255	KL 2740.....	259	KL 3480.....	261
GF 8750.....	32	GFB 6223-1.....	30	KG 0156.....	46	KL 2207.....	255	KL 2742.....	261	KL 3481.....	261
GF 8760.....	32	GFB 6225.....	30	KG 0157.....	47	KL 2208.....	255	KL 2743.....	261	KL 3492.....	261
GF 8763.....	32	GFB 6225-1.....	30	KG 0157S.....	47	KL 2209.....	255	KL 2744.....	261	KL 3493.....	261
		GFB 6315.....	30	KG 0158.....	47	KL 2210.....	256	KL 2745.....	261	KL 4010.....	267
		GFB 6318.....	30, 316	KG 0159.....	47	KL 2211.....	256	KL 2746.....	261	KL 4010-1.....	267
		GFB 6321.....	30	KG 0161.....	46	KL 2212.....	256	KL 2747.....	261	KL 4030.....	267
		GFB 6323.....	30			KL 2213.....	256	KL 2748.....	261	KL 4040.....	272
		GFB 6325.....	30	KL 0010.....	251	KL 2214.....	255	KL 2749.....	261	KL 4041.....	268
		GFB 6518.....	30	KL 0091.....	248	KL 2215.....	255	KL 2770.....	262	KL 4042.....	268

# Index Artikelnummern

## Index Item Numbers

	Seite page		Seite page		Seite page		Seite page		Seite page		
KL 4043.....	268	KL 4480.....	277	MN 1345D.....	9	MN 6028.....	137	NH 0524.....	14	NH 8012.....	4
KL 4044.....	268	KL 4481.....	277	MN 1346D.....	9	MN 6029.....	137	NH 0525.....	14	NH 8013.....	4
KL 4049.....	267	KL 4482.....	277	MN 1347D.....	9	MN 6030.....	137	NH 0526.....	14	NH 8014.....	5
KL 4050.....	267	KL 4483.....	277	MN 1348D.....	9	MN 6031.....	137	NH 0527.....	14	NH 8015.....	5
KL 4051.....	270	KL 4484.....	277	MN 1349D.....	9	MN 6032.....	137	NH 0530.....	14	NH 8016.....	4
KL 4052.....	270	KL 4485.....	277	MN 1351.....	9	MN 6033.....	137	NH 0531.....	14	NH 8016-1.....	4
KL 4053.....	270	KL 4493.....	275	MN 1351D.....	9	MN 6034.....	137	NH 0560.....	17	NH 8016-2.....	4
KL 4060.....	267	KL 4495.....	275	MN 1352.....	9	MN 6035.....	137	NH 0570.....	17	NH 8016F.....	4
KL 4070.....	279	KL 4506.....	273	MN 1352D.....	9	MN 6036.....	137	NH 0575.....	17	NH 8017.....	4
KL 4080.....	279	KL 4530.....	279	MN 1353.....	9	MN 6038.....	137	NH 0576.....	17	NH 8018.....	4
KL 4090.....	279	KL 4540.....	279	MN 1353D.....	9	MN 6040.....	137	NH 0580.....	17	NH 8018F.....	4
KL 4100.....	279	KL 4982.....	286	MN 1354.....	9	MN 8085.....	28	NH 0590.....	17	NH 8019.....	4
KL 4111.....	274			MN 1354D.....	9	MN 8086.....	28	NH 0595.....	17	NH 8020.....	4
KL 4112.....	274	<b>M</b>		MN 1355.....	9	MN 8087.....	28	NH 0596.....	17	NH 8020F.....	4
KL 4113.....	274	MD 0835.....	11	MN 1355D.....	9	MN 8502.....	25	NH 0740.....	18	NH 8021.....	4
KL 4114.....	274	MD 0835T.....	11	MN 1430.....	34	MN 8660.....	28	NH 0742.....	18	NH 8022.....	4
KL 4115.....	274	MD 0940.....	227	MN 1822.....	139	MN 8661.....	28	NH 0743.....	18	NH 8026.....	4
KL 4116.....	274	MD 8834.....	5	MN 1828.....	302			NH 0745.....	18	NH 8028.....	4
KL 4117.....	274	MD 8835.....	5	MN 1839.....	317	<b>N</b>		NH 0790.....	19	NH 8030.....	2
KL 4120.....	280	MD 8835-1.....	5	MN 2300.....	296	ND 0852.....	304	NH 0870.....	20	NH 8032.....	4
KL 4125.....	276	MN 0084.....	33	MN 2391.....	138			NH 0890.....	20	NH 8033.....	4
KL 4125-1.....	276	MN 0087.....	33	MN 2392.....	138	NH 0150.....	15	NH 0910.....	20	NH 8038.....	7
KL 4126.....	276	MN 0089.....	33	MN 2393.....	138	NH 0200.....	15	NH 0929.....	21	NH 8040.....	7
KL 4126-1.....	276	MN 0269.....	56	MN 2394.....	138	NH 0200-1.....	15	NH 0930.....	21	NH 8060.....	3
KL 4130.....	280	MN 0277.....	56	MN 2500.....	138	NH 0210.....	15	NH 0931.....	20	NH 8064.....	3
KL 4140.....	280	MN 0277N.....	56	MN 2505.....	138	NH 0230.....	15	NH 0932.....	20	NH 8066.....	3
KL 4141.....	280	MN 0278.....	56	MN 2510.....	138	NH 0230F.....	15	NH 0933.....	20	NH 8070.....	4
KL 4150.....	280	MN 0279.....	56	MN 2515.....	138	NH 0240.....	15	NH 0940.....	21	NH 8070-1.....	5
KL 4160.....	280	MN 0583T.....	6	MN 2520.....	138	NH 0260.....	15	NH 0980.....	21	NH 8070-2.....	5
KL 4170.....	280	MN 0653.....	57	MN 2525.....	138	NH 0265.....	15	NH 1000.....	21	NH 8070-3.....	5
KL 4180.....	280	MN 0740.....	296	MN 2530.....	138	NH 0270.....	16	NH 1038.....	20	NH 8074.....	4
KL 4181.....	280	MN 0760.....	296	MN 2535.....	138	NH 0280.....	15	NH 1068.....	20	NH 8076.....	5
KL 4182.....	276	MN 0780.....	296	MN 2540.....	138	NH 0300.....	16	NH 1069.....	20	NH 8078.....	5
KL 4184.....	280	MN 0800.....	296	MN 2545.....	138	NH 0310.....	15	NH 1070.....	20	NH 8079.....	5
KL 4185.....	281	MN 0810.....	296	MN 4591.....	181	NH 0328.....	14	NH 1071.....	20	NH 8098.....	6
KL 4185-1.....	281	MN 0830.....	296	MN 4592.....	181	NH 0329.....	14	NH 1120.....	15	NH 8099.....	6
KL 4185-2.....	281	MN 0850.....	296	MN 4593.....	181	NH 0330.....	14	NH 1130.....	15	NH 8100.....	6
KL 4185-3.....	281	MN 0860.....	296	MN 4594.....	181	NH 0331.....	14	NH 1180.....	15	NH 8102.....	6
KL 4185-4.....	281	MN 0880.....	296	MN 4596.....	181	NH 0332.....	14	NH 1200.....	15	NH 8103.....	6
KL 4185-5.....	281	MN 0900.....	296	MN 4597.....	181	NH 0350.....	16	NH 2008.....	19	NH 8104.....	6
KL 4188.....	281	MN 0920.....	296	MN 4598.....	181	NH 0360.....	16	NH 2009.....	19	NH 8105.....	6
KL 4190.....	280	MN 0940.....	296	MN 5503.....	33	NH 0361.....	16	NH 2010.....	19	NH 8108.....	6
KL 4200.....	280	MN 0950.....	296	MN 5513.....	33	NH 0370.....	16	NH 2012.....	19	NH 8111.....	6
KL 4204.....	280	MN 0960.....	296	MN 6000.....	137	NH 0380.....	16	NH 2050.....	18	NH 8118.....	4
KL 4210.....	280	MN 0970.....	296	MN 6001.....	137	NH 0380F.....	16	NH 2056.....	18	NH 8310.....	4
KL 4220.....	280	MN 0980.....	296	MN 6002.....	137	NH 0385.....	16	NH 2057.....	18	NH 8348.....	4
KL 4230.....	280	MN 1300.....	9	MN 6003.....	137	NH 0390.....	16	NH 2058.....	18	NH 8349.....	4
KL 4232.....	280	MN 1310.....	9	MN 6004.....	137	NH 0400.....	16	NH 2060.....	18	NH 8411.....	3
KL 4290.....	262	MN 1320.....	9	MN 6005.....	137	NH 0410.....	16	NH 3009.....	8	NH 8520.....	5
KL 4300.....	262	MN 1320D.....	9	MN 6006.....	137	NH 0431.....	17	NH 3010.....	8	NH 8802.....	13
KL 4311.....	275	MN 1330.....	9	MN 6007.....	137	NH 0432.....	17	NH 3010-1.....	8	NH 8804.....	13
KL 4340.....	275	MN 1330D.....	9	MN 6008.....	137	NH 0433.....	17	NH 6000.....	13	NH 8806.....	13
KL 4350.....	272	MN 1332.....	9	MN 6009.....	137	NH 0434.....	17	NH 6001.....	13	NH 8808.....	13
KL 4351.....	272	MN 1332D.....	9	MN 6010.....	137	NH 0435.....	17	NH 6002.....	13	NH 8810.....	13
KL 4381.....	276	MN 1333.....	9	MN 6011.....	137	NH 0436.....	17	NH 6003.....	13	NH 8900.....	2
KL 4382.....	276	MN 1333D.....	9	MN 6012.....	137	NH 0440.....	14	NH 6003TC.....	13	NH 8901.....	2
KL 4384.....	271	MN 1334.....	9	MN 6013.....	137	NH 0441.....	14	NH 6015.....	13	NH 8981.....	2
KL 4400.....	278	MN 1334D.....	9	MN 6014.....	137	NH 0450.....	14	NH 6016.....	13		
KL 4410.....	278	MN 1335.....	9	MN 6015.....	137	NH 0460.....	14	NH 6018.....	13	NHB 1004.....	13
KL 4420.....	278	MN 1335D.....	9	MN 6016.....	137	NH 0468.....	14	NH 6022.....	13	NHB 4515.....	12
KL 4430.....	278	MN 1338.....	9	MN 6017.....	137	NH 0470.....	14	NH 6025.....	13	NHB 4515S.....	12
KL 4440.....	278	MN 1338D.....	9	MN 6018.....	137	NH 0500.....	14	NH 6028.....	13	NHB 4520S.....	317
KL 4450.....	278	MN 1339.....	9	MN 6019.....	137	NH 0510.....	14	NH 6030.....	13	NHB 4525.....	12
KL 4455.....	278	MN 1339D.....	9	MN 6020.....	137	NH 0512.....	14	NH 6033.....	13	NHB 4525S.....	12
KL 4460.....	278	MN 1340D.....	9	MN 6021.....	137	NH 0513.....	14	NH 8005.....	2	NHB 4526S.....	317
KL 4470.....	278	MN 1341D.....	9	MN 6022.....	137	NH 0514.....	14	NH 8006.....	2		
KL 4471.....	277	MN 1342.....	9	MN 6023.....	137	NH 0515.....	14	NH 8008.....	4		
KL 4473.....	277	MN 1342D.....	9	MN 6024.....	137	NH 0516.....	14	NH 8009.....	4		
KL 4474.....	277	MN 1343.....	9	MN 6025.....	137	NH 0520.....	14	NH 8010.....	4, 316		
KL 4475.....	277	MN 1343D.....	9	MN 6026.....	137	NH 0522.....	14	NH 8010F.....	4		
KL 4479.....	277	MN 1344D.....	9	MN 6027.....	137	NH 0523.....	14	NH 8011.....	4		

	Seite page		Seite page		Seite page		Seite page		Seite page
NHB 4535.....	12	NHB 5354S.....	10	PZ 0367.....	38	PZ 1144.....	40	SC 0047.....	51
NHB 4535S.....	12	NHB 5357.....	10	PZ 0368.....	38	PZ 1150.....	40	SC 0047T.....	54
NHB 4545.....	12	NHB 5357S.....	10	PZ 0369.....	38	PZ 1160.....	40	SC 0048.....	51
NHB 4545S.....	12	NHB 5554S.....	12	PZ 0380.....	42	PZ 1170.....	40	SC 0048T.....	54
NHB 4597S.....	12	NHB 5555.....	12	PZ 0385.....	43	PZ 1180.....	40	SC 0067.....	317
NHB 4627.....	12	NHB 5555S.....	12	PZ 0386.....	42	PZ 1190.....	40	SC 0070.....	52
NHB 4705S.....	12	NHB 5556S.....	12	PZ 0387.....	43	PZ 1200.....	40	SC 0071.....	52
NHB 4706S.....	12	NHB 5700S.....	8	PZ 0389.....	42	PZ 1460.....	41	SC 0072.....	52
NHB 4707S.....	12	NHB 7088.....	11	PZ 0390.....	42	PZ 1470.....	41	SC 0073.....	52
NHB 4708S.....	12	NHB 7088S.....	11	PZ 0398.....	42	PZ 1540.....	40	SC 0074.....	52
NHB 4715.....	12	NHB 7089.....	11	PZ 0400.....	42	PZ 1542.....	39	SC 0075.....	52
NHB 4715S.....	12	NHB 7089S.....	11	PZ 0410.....	42	PZ 1544.....	39	SC 0076.....	52
NHB 4725.....	12	NHB 8141.....	7	PZ 0416.....	29	PZ 1546.....	39	SC 0080.....	52
NHB 4725S.....	12	NHB 8141S.....	7	PZ 0417.....	29	PZ 1548.....	39	SC 0081.....	52
NHB 4735.....	12	NHB 8191.....	7	PZ 0418.....	29	PZ 1550.....	40	SC 0089.....	50
NHB 4735S.....	12	NHB 8191S.....	7	PZ 0420.....	42	PZ 1554.....	39	SC 0089T.....	53
NHB 4745.....	12	NHB 8194.....	7	PZ 0426.....	29	PZ 1560.....	39	SC 0091.....	51
NHB 4745S.....	12	NHB 8194S.....	7	PZ 0427.....	29	PZ 1570.....	39	SC 0091-1T.....	55
NHB 4815S.....	12	NHB 8529S.....	3	PZ 0428.....	29	PZ 1580.....	39	SC 0091T.....	55
NHB 4825S.....	12	NHB 8627S.....	3	PZ 0430.....	42	PZ 1600.....	39	SC 0092.....	51
NHB 4834S.....	12	NHB 8741S.....	7	PZ 0431.....	43	PZ 1674.....	39	SC 0092-1.....	52, 55
NHB 4835S.....	12	NHB 8927S.....	3	PZ 0432.....	43	PZ 1710.....	39	SC 0092-1T.....	55
NHB 4845S.....	12			PZ 0433.....	43	PZ 1720.....	39	SC 0092T.....	55
NHB 4915S.....	12	<b>P</b>		PZ 0434.....	43	PZ 1725.....	39	SC 0093.....	51
NHB 4925S.....	12	PZ 0005.....	48	PZ 0435.....	43	PZ 1728.....	39	SC 0093-1.....	55
NHB 4935S.....	12	PZ 0006.....	48	PZ 0436.....	29	PZ 8005.....	27	SC 0093-1T.....	55
NHB 4945S.....	12	PZ 0007.....	48	PZ 0437.....	29			SC 0093T.....	55
NHB 5119.....	8	PZ 0008.....	48	PZ 0438.....	29	<b>S</b>		SC 0094.....	51
NHB 5125.....	10	PZ 0009.....	48	PZ 0441.....	42	SC 0004.....	50	SC 0094-1.....	52, 55
NHB 5125S.....	10	PZ 0010.....	48	PZ 0446.....	29	SC 0005.....	50	SC 0094-1T.....	55
NHB 5127.....	10	PZ 0014.....	48	PZ 0447.....	29	SC 0005T.....	53	SC 0094T.....	55
NHB 5127S.....	10	PZ 0021.....	48	PZ 0448.....	29	SC 0006.....	50	SC 0095.....	51
NHB 5141.....	10	PZ 0022.....	48	PZ 0520.....	35	SC 0006T.....	53	SC 0095-1.....	52, 55
NHB 5141S.....	10	PZ 0031.....	48	PZ 0521.....	35	SC 0007.....	50	SC 0095-1T.....	55
NHB 5145.....	10	PZ 0033.....	48	PZ 0530.....	35	SC 0007T.....	53	SC 0095T.....	55
NHB 5145S.....	10	PZ 0034.....	48	PZ 0531.....	35	SC 0008.....	50	SC 0096.....	51
NHB 5147.....	10	PZ 0034-1.....	48	PZ 0550.....	35	SC 0008T.....	53	SC 0096-1.....	52, 55
NHB 5147S.....	10	PZ 0035.....	48	PZ 0551.....	35	SC 0009.....	50	SC 0096-1T.....	55
NHB 5148.....	10	PZ 0038.....	48	PZ 0560.....	35	SC 0009T.....	53	SC 0096T.....	55
NHB 5148S.....	10	PZ 0040.....	48	PZ 0561.....	35	SC 0010.....	50	SC 0101.....	50
NHB 5155.....	10	PZ 0120.....	36	PZ 0566.....	35	SC 0010T.....	53	SC 0101T.....	53
NHB 5155S.....	10	PZ 0130.....	36	PZ 0567.....	35	SC 0022.....	56	SC 0103.....	50
NHB 5157.....	10	PZ 0140.....	36	PZ 0569.....	35	SC 0031.....	50	SC 0103T.....	53
NHB 5157S.....	10	PZ 0145.....	36	PZ 0570.....	35	SC 0031T.....	53	SC 0104.....	50
NHB 5158.....	10	PZ 0150.....	36	PZ 0584.....	38	SC 0032.....	50	SC 0104T.....	53
NHB 5158S.....	10	PZ 0160.....	36	PZ 0586.....	38	SC 0032T.....	53	SC 0105.....	50
NHB 5185.....	10	PZ 0170.....	36	PZ 0630.....	37	SC 0033.....	50	SC 0105T.....	53
NHB 5185S.....	10	PZ 0171.....	36	PZ 0632.....	37	SC 0033T.....	53	SC 0106.....	50
NHB 5187.....	10	PZ 0180.....	36	PZ 0660.....	38	SC 0034.....	50	SC 0106T.....	53
NHB 5187S.....	10	PZ 0190.....	36	PZ 0920.....	34	SC 0034T.....	53	SC 0107.....	50
NHB 5188.....	10	PZ 0199.....	37	PZ 0930.....	34	SC 0035.....	50	SC 0107T.....	53
NHB 5188S.....	10	PZ 0200.....	37	PZ 0940.....	34	SC 0035T.....	53	SC 0134.....	50
NHB 5191.....	10	PZ 0201.....	36	PZ 0950.....	34	SC 0036.....	50	SC 0134T.....	53
NHB 5191S.....	10	PZ 0202.....	36	PZ 1051.....	41	SC 0036T.....	53	SC 0135.....	50
NHB 5194.....	10	PZ 0203.....	36	PZ 1052.....	41	SC 0037.....	50	SC 0135T.....	53
NHB 5194S.....	10	PZ 0204.....	36	PZ 1055.....	41	SC 0037T.....	53	SC 0136.....	50
NHB 5195.....	10	PZ 0205.....	36	PZ 1056-1.....	41	SC 0038.....	50	SC 0136T.....	53
NHB 5195S.....	10	PZ 0206.....	36	PZ 1062.....	41	SC 0038T.....	53	SC 0137.....	50
NHB 5197.....	10	PZ 0207.....	36	PZ 1118.....	41	SC 0039.....	317	SC 0137T.....	53
NHB 5197S.....	10	PZ 0208.....	36	PZ 1119.....	41	SC 0041.....	51	SC 0138.....	50
NHB 5198.....	10	PZ 0210.....	37	PZ 1120.....	41	SC 0041T.....	54	SC 0138T.....	53
NHB 5198S.....	10	PZ 0212.....	37	PZ 1121.....	41	SC 0042.....	51	SC 0139.....	50
NHB 5201S.....	10	PZ 0213.....	37	PZ 1122.....	41	SC 0042T.....	54	SC 0139T.....	53
NHB 5287S.....	10	PZ 0214.....	37	PZ 1123.....	41	SC 0043.....	51	SC 0141.....	50
NHB 5354.....	10	PZ 0216.....	37	PZ 1124.....	41	SC 0043T.....	54	SC 0141T.....	53
		PZ 0217.....	37	PZ 1125.....	41	SC 0044.....	51	SC 0144.....	51
		PZ 0362.....	38	PZ 1130.....	40	SC 0044T.....	54	SC 0144T.....	54
		PZ 0363.....	38	PZ 1140.....	40	SC 0045.....	51	SC 0145.....	51
		PZ 0364.....	38	PZ 1141.....	40	SC 0045T.....	54	SC 0145T.....	54
		PZ 0365.....	38	PZ 1142.....	40	SC 0046.....	51	SC 0146.....	51
		PZ 0366.....	38	PZ 1143.....	40	SC 0046T.....	54	SC 0146T.....	54

Index Artikelnummern  
Index Item Numbers

	Seite page		Seite page		Seite page		Seite page		Seite page		
SC 0228.....	51	SC 1000.....	120	SC 1601.....	81	SC 2697.....	90	SC 7494.....	95	SC 8096.....	71
SC 0228T.....	54	SC 1001.....	120	SC 1602.....	80	SC 2698.....	90	SC 7496.....	95	SC 8097.....	71
SC 0229.....	51	SC 1004.....	120	SC 1603.....	81	SC 2699.....	90	SC 7498.....	95	SC 8098.....	71
SC 0229T.....	54	SC 1005.....	120	SC 1604.....	80	SC 2753.....	59	SC 7500.....	95	SC 8105.....	70
SC 0426.....	75	SC 1006.....	120	SC 1605.....	81	SC 2763.....	59	SC 7510.....	93	SC 8105-1.....	70
SC 0427.....	75	SC 1007.....	120	SC 1606.....	80	SC 2763S.....	59	SC 7512.....	93	SC 8107.....	70
SC 0429.....	108	SC 1008.....	121	SC 1607.....	81	SC 2799.....	91	SC 7513.....	94	SC 8107-1.....	70
SC 0430.....	75	SC 1009.....	121	SC 1608.....	80	SC 2800.....	91	SC 7514.....	93	SC 8130.....	74
SC 0431.....	75	SC 1011.....	121	SC 1609.....	81	SC 3821.....	58	SC 7515.....	94	SC 8140.....	66
SC 0432.....	75	SC 1013.....	121	SC 1841.....	58	SC 3831.....	58	SC 7516.....	93	SC 8141.....	66
SC 0433.....	75	SC 1015.....	121	SC 1842.....	58	SC 3841.....	58	SC 7517.....	94	SC 8143.....	66
SC 0442.....	108	SC 1021.....	121	SC 1843.....	58	SC 3851.....	58	SC 7518.....	93	SC 8145.....	66
SC 0443.....	108	SC 1105.....	90	SC 1930.....	84	SC 3861.....	58	SC 7519.....	94	SC 8150.....	61, 66
SC 0470.....	75	SC 1107.....	90	SC 1932.....	84	SC 7037.....	96	SC 7520.....	93	SC 8151.....	66
SC 0475.....	108	SC 1126.....	57	SC 1934.....	84	SC 7039.....	96	SC 7521.....	94	SC 8153.....	66
SC 0477.....	75	SC 1135.....	57	SC 1940.....	84	SC 7041.....	96	SC 7524.....	93	SC 8219.....	74
SC 0650.....	82	SC 1136.....	57	SC 1942.....	84	SC 7043.....	96	SC 7525.....	94	SC 8221.....	74
SC 0651.....	82	SC 1137.....	57	SC 1943.....	84	SC 7045.....	96	SC 7526.....	93	SC 8225.....	74
SC 0654.....	111	SC 1138.....	57	SC 1944.....	84	SC 7047.....	96	SC 7527.....	94	SC 8251.....	70
SC 0655.....	111	SC 1140.....	122	SC 2090.....	83	SC 7049.....	96	SC 7530.....	106	SC 8273.....	68
SC 0656.....	82	SC 1150.....	122	SC 2091.....	83	SC 7051.....	96	SC 7580.....	97	SC 8275.....	68
SC 0657.....	111	SC 1280.....	114	SC 2092.....	83	SC 7090.....	99	SC 7581.....	97	SC 8280.....	67
SC 0658.....	82	SC 1310.....	114	SC 2093.....	83	SC 7091.....	99	SC 7582.....	97	SC 8281.....	67
SC 0659.....	111	SC 1312.....	116	SC 2096.....	112	SC 7092.....	99	SC 7583.....	97	SC 8282.....	68
SC 0670.....	82	SC 1313.....	116	SC 2097.....	112	SC 7093.....	99	SC 7584.....	97	SC 8283.....	67
SC 0671.....	82	SC 1314.....	116	SC 2098.....	112	SC 7140.....	106	SC 7585.....	97	SC 8285.....	67
SC 0680.....	111	SC 1315.....	116	SC 2099.....	112	SC 7240.....	101	SC 7586.....	97	SC 8287.....	69
SC 0681.....	111	SC 1318.....	116	SC 2240.....	85	SC 7241.....	101	SC 7587.....	97	SC 8289.....	69
SC 0682.....	111	SC 1320.....	115	SC 2241.....	85	SC 7260.....	101	SC 7588.....	97	SC 8291.....	69
SC 0683.....	111	SC 1321.....	115	SC 2260.....	85	SC 7280.....	102	SC 7589.....	97	SC 8297.....	69
SC 0690.....	82	SC 1322.....	115	SC 2280.....	86	SC 7281.....	102	SC 7598.....	97	SC 8308.....	71
SC 0691.....	82	SC 1323.....	115	SC 2281.....	86	SC 7284.....	102	SC 7650.....	98	SC 8310.....	71
SC 0719.....	83, 317	SC 1324.....	115	SC 2284.....	86	SC 7285.....	102	SC 7651.....	98	SC 8313.....	67
SC 0720.....	83	SC 1325.....	115	SC 2285.....	86	SC 7286.....	102	SC 7656.....	98	SC 8315.....	67
SC 0721.....	112	SC 1326.....	115	SC 2286.....	86	SC 7287.....	102	SC 7658.....	98	SC 8323-1.....	67
SC 0722.....	83	SC 1327.....	115	SC 2287.....	86	SC 7288.....	103	SC 7670.....	98	SC 8325.....	67
SC 0724.....	112	SC 1329.....	115	SC 2288.....	87	SC 7289.....	103	SC 7671.....	98	SC 8370.....	72
SC 0800.....	108	SC 1456.....	78	SC 2289.....	87	SC 7290.....	103	SC 7690.....	98	SC 8371.....	72
SC 0840.....	108	SC 1457.....	79	SC 2290.....	87	SC 7291.....	103	SC 7691.....	98	SC 8410.....	62
SC 0841.....	108	SC 1458.....	78	SC 2291.....	87	SC 7292.....	103	SC 7720.....	99	SC 8411.....	62
SC 0851.....	110	SC 1459.....	79	SC 2292.....	87	SC 7293.....	103	SC 7722.....	99	SC 8426.....	62
SC 0852.....	110	SC 1460.....	78	SC 2293.....	87	SC 7300.....	104	SC 7930.....	100	SC 8427.....	62
SC 0855.....	108	SC 1461.....	79	SC 2300.....	88	SC 7301.....	104	SC 7932.....	100	SC 8436.....	62
SC 0856.....	108	SC 1462.....	78	SC 2301.....	88	SC 7304.....	104	SC 7933.....	100	SC 8437.....	62
SC 0870.....	109	SC 1463.....	79	SC 2304.....	88	SC 7305.....	104	SC 7934.....	100	SC 8438.....	62
SC 0871.....	109	SC 1464.....	78	SC 2305.....	88	SC 7306.....	104	SC 7936.....	100	SC 8439.....	62
SC 0872.....	109	SC 1465.....	79	SC 2306.....	88	SC 7307.....	104	SC 7938.....	100	SC 8440.....	64
SC 0873.....	109	SC 1466.....	78	SC 2307.....	88	SC 7307S.....	106	SC 7971.....	107	SC 8441.....	64
SC 0880.....	60	SC 1467.....	79	SC 2308.....	89	SC 7308.....	105	SC 8000.....	66	SC 8442.....	64
SC 0890.....	113	SC 1468.....	78	SC 2309.....	89	SC 7309.....	105	SC 8001.....	66	SC 8447.....	64
SC 0891.....	113	SC 1469.....	79	SC 2310.....	89	SC 7309S.....	106	SC 8002.....	64	SC 8450.....	74
SC 0892.....	113	SC 1470.....	78	SC 2311.....	89	SC 7310.....	105	SC 8004.....	64	SC 8451.....	73
SC 0893.....	113	SC 1471.....	79	SC 2312.....	89	SC 7311.....	105	SC 8005.....	68	SC 8452.....	73
SC 0894.....	113	SC 1510.....	76	SC 2313.....	89	SC 7311S.....	106	SC 8006.....	68	SC 8463.....	73
SC 0895.....	113	SC 1512.....	76	SC 2314.....	89	SC 7311SS.....	106	SC 8007.....	68	SC 8467.....	73
SC 0980.....	117	SC 1513.....	77	SC 2315.....	89	SC 7312.....	105	SC 8008.....	68	SC 8515.....	64
SC 0981.....	117	SC 1514.....	76	SC 2520.....	90	SC 7313.....	105	SC 8009.....	68	SC 8560.....	59
SC 0982.....	117	SC 1515.....	77	SC 2530.....	90	SC 7313S.....	106	SC 8010.....	69	SC 8561.....	59
SC 0983.....	117	SC 1516.....	76	SC 2570.....	91	SC 7314.....	105	SC 8011.....	69	SC 8562.....	59
SC 0986.....	117	SC 1517.....	77	SC 2571.....	91	SC 7315.....	105	SC 8013.....	69	SC 8580.....	63
SC 0987.....	117	SC 1518.....	76	SC 2574.....	107	SC 7426.....	92	SC 8015.....	69	SC 8583.....	63
SC 0987-1.....	119	SC 1519.....	77	SC 2590.....	91	SC 7427.....	92	SC 8017.....	69	SC 8590.....	72
SC 0988.....	118	SC 1520.....	76	SC 2654.....	122	SC 7430.....	92	SC 8018.....	69	SC 8626.....	65
SC 0989.....	118	SC 1521.....	77	SC 2655.....	122	SC 7431.....	92	SC 8019.....	63	SC 8651.....	65
SC 0990.....	118	SC 1522.....	76	SC 2656.....	122	SC 7432.....	92	SC 8032.....	73	SC 8652.....	65
SC 0991.....	118	SC 1524.....	76	SC 2691.....	90	SC 7433.....	92	SC 8033.....	73		
SC 0992.....	118	SC 1525.....	77	SC 2692.....	90	SC 7470.....	92	SC 8057.....	70		
SC 0993.....	118	SC 1526.....	76	SC 2693.....	90	SC 7486.....	95	SC 8057-F.....	70		
SC 0996.....	119	SC 1527.....	77	SC 2694.....	90	SC 7488.....	95	SC 8059.....	70		
SC 0997.....	119	SC 1598.....	80	SC 2695.....	90	SC 7490.....	95	SC 8061.....	70		
SC 0998.....	119	SC 1600.....	80	SC 2696.....	90	SC 7492.....	95	SC 8075.....	64		



Index Artikelnummern  
*Index Item Numbers*

	Seite <i>page</i>		Seite <i>page</i>
YA 0253T.....	135	YA 1150.....	133
YA 0536.....	136	YA 1150T.....	133
YA 0536T.....	136	YA 1155.....	132
YA 0541.....	136	YA 1155T.....	132
YA 0541T.....	136	YA 1160.....	132
YA 0546.....	136	YA 1160T.....	132
YA 0546T.....	136	YA 1165.....	132
YA 0551.....	136	YA 1165T.....	132
YA 0551T.....	136	YA 1170.....	133
YA 0556.....	136	YA 1170T.....	133
YA 0556T.....	136	YA 1175.....	133
YA 0561.....	136	YA 1175T.....	133
YA 0561T.....	136	YA 1176.....	133
YA 0706.....	136	YA 1176T.....	133
YA 0706T.....	136	YA 1177.....	133
YA 0711.....	136	YA 1177T.....	133
YA 0711T.....	136	YA 1180.....	132
YA 0716.....	136	YA 1180T.....	132
YA 0716T.....	136	YA 1185.....	132,133
YA 0721.....	136	YA 1185T.....	132,133
YA 0721T.....	136	YA 1190.....	132
YA 0726.....	136	YA 1190T.....	132
YA 0726T.....	136	YA 1195.....	133
YA 0731.....	136	YA 1195T.....	133
YA 0731T.....	136	YA 1200.....	132
YA 0736.....	136	YA 1200T.....	132
YA 0736T.....	136	YA 1205.....	132
YA 0741.....	136	YA 1205T.....	132
YA 0741T.....	136	YA 1210.....	132
YA 0746.....	136	YA 1210T.....	132
YA 0746T.....	136	YA 1211.....	132
YA 0751.....	136	YA 1211T.....	132
YA 0751T.....	136	YA 1215.....	132
YA 0756.....	136	YA 1215T.....	132
YA 0756T.....	136	YA 1216.....	132
YA 1014.....	134	YA 1216T.....	132
YA 1014T.....	134	YA 1225.....	132
YA 1015.....	133	YA 1225T.....	132
YA 1015T.....	133	YA 1226.....	132
YA 1016.....	134	YA 1226T.....	132
YA 1016T.....	134	YA 1230.....	132
YA 1017.....	134	YA 1230T.....	132
YA 1017T.....	134	YA 1260.....	133
YA 1018.....	134, 135	YA 1260T.....	133
YA 1018T.....	134, 135	YA 1265.....	133
YA 1019.....	134	YA 1265T.....	133
YA 1019T.....	134	YA 1270.....	133
YA 1020.....	133	YA 1270T.....	133
YA 1020T.....	133	YA 1275.....	132
YA 1024.....	134	YA 1275T.....	132
YA 1024T.....	134	YA 1280.....	132
YA 1025.....	133	YA 1280T.....	132
YA 1025T.....	133	YA 1290.....	133
YA 1026.....	134	YA 1290T.....	133
YA 1026T.....	134	YA 1295.....	133
YA 1027.....	134	YA 1295T.....	133
YA 1027T.....	134	YA 1300.....	133
YA 1028.....	134	YA 1300T.....	133
YA 1028T.....	134	YA 1305.....	133
YA 1125.....	132	YA 1305T.....	133
YA 1125T.....	132	YA 1310.....	133
YA 1130.....	132	YA 1310T.....	133
YA 1130T.....	132	YA 1350.....	135, 316
YA 1135.....	132	YA 1355.....	135
YA 1135T.....	132	YA 1360.....	135
YA 1140.....	133	YA 1367.....	135
YA 1140T.....	133		
YA 1145.....	133		
YA 1145T.....	133		
YA 1148.....	133		
YA 1148T.....	133		

S-3 STERI-SYSTEM  
STERILISATIONSCONTAINER  
STERILIZATION CONTAINERS

**ASANUS**  
MEDIZINTECHNIK

ASANUS Medizintechnik GmbH  
Unit of Garmisch-Partenkirchen  
75750 Garmisch-Partenkirchen  
Germany (Bavaria, Tullaanger)  
Tel. +49 (0) 7467 9474-0  
Fax +49 (0) 7467 9474-50  
e mail info@asanus.de

**Aclean**

Maschinelle Reinigung

Zertifiziert prionenwirksam  
(Creutzfeldt-Jakob-Erreger)  
Funktion ohne VE-Wasser  
Kostensparend  
Schonende Reinigung für erhöhte Lebensdauer der Maschinen  
und Instrumente  
Geringe Dosierung - bei optimaler Effizienz

**WE ARE DIFFERENT**

**ASANUS**  
MEDIZINTECHNIK

MULTI POWER SYSTEM  
MULTI POWER SYSTEM

BARCODE & RFID SOFTWARE SYSTEM  
FÜR MATERIAL-, KOSTEN UND STERILITÄTSMANAGEMENT  
FOR MATERIAL COST AND STERILE INSTRUMENT MANAGEMENT

FOR PROFESSIONALS

**ASANUS**  
SOFTWARE

**www.asanus.de**

**Weltneuheit!**  
Wardfield's security

**RF-ID CHIP**

**MediPlug**  
- individual chip  
- on-site identification of each single instrument

**ARIS**

**SOFTWARE**

for professional Anwender  
in Klinik und Ambulanz

- No. 1 in Qualität und Absicherbarkeit
- Branchenweitens meist einfach zu bedienend
- Effektiv ohne großen Aufwand
- Schritte werden hoch in die Hierarchie an
- Arbeitsabläufe und vollständige EDV-Ebene
- kompletter Aufbau und vieles mehr

for professional clinical and ambulant usage

- No. 1 in Qualität und Absicherbarkeit
- branchenweitens meist einfach zu bedienend
- Effektiv ohne großen Aufwand
- Schritte werden hoch in die Hierarchie an
- Arbeitsabläufe und vollständige EDV-Ebene
- kompletter Aufbau und vieles mehr

**INSTRUMENTE**

für jeden medizinischen Bereich  
for every medical sector

**ASANUS**  
MEDIZINTECHNIK

Asanus Medizintechnik GmbH  
Unit of Garmisch-Partenkirchen 2  
75759 Garmisch-Partenkirchen  
Germany (Bavaria, Tullaanger)

Tel. +49 7467 9474-0  
Fax +49 7467 9474-50  
info@asanus.de  
www.asanus.de

© by ASANUS®

Nachdruck, auch auszugsweise, ist verboten.

Alle unsere Kataloge und Prospekte sowie Preislisten dürfen Dritten nicht zugänglich gemacht werden. Es gelten unsere allgemeinen Lieferungs- und Zahlungsbedingungen, die in unserer Preisliste enthalten sind.

Vom Katalog abweichende Modelländerungen behalten wir uns vor.

Reprinting even partially is not allowed.

Non of our catalogues may be opened to third parties. All deliveries are subject to the general conditions of payment and supply which may be found in our price list.

Patterns are subject to change.



Maßtabelle  
Measurement table

MM	ZOLL (INCH)
25	1
30	1 1/8
35	1 1/4
40	1 1/2
45	1 3/4
50	2
55	2 1/8
60	2 1/4
65	2 1/2
70	2 3/4
75	3
80	3 1/8
85	3 1/4
90	3 1/2
95	3 3/4
100	4
105	4 1/8
110	4 1/4
115	4 1/2
120	4 3/4
125	5
130	5 1/8
135	5 1/4
140	5 1/2
145	5 3/4
150	6
155	6 1/8
160	6 1/4
165	6 1/2
170	6 3/4
175	7
180	7 1/8
185	7 1/4
190	7 1/2
195	7 3/4
200	8
205	8 1/8
210	8 1/4
215	8 1/2
220	8 3/4
225	9
230	9 1/8
235	9 1/4
240	9 1/2
245	9 3/4
250	10
255	10 1/8
260	10 1/4
265	10 1/2
270	10 3/4
275	11
280	11 1/8
285	11 1/4
290	11 1/2
295	11 3/4
300	12
305	12 1/8
310	12 1/4
320	12 1/2
325	12 3/4
330	13

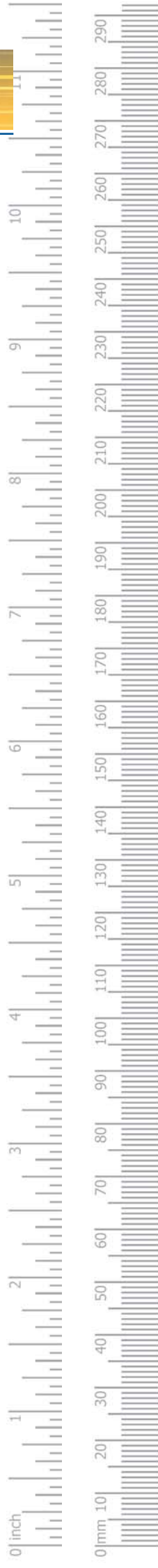

---

**WE ARE DIFFERENT**



Certificated Authorized Distributor



Asanus Medizintechnik GmbH  
take off Gewerbepark 2  
78579 Neuhausen ob Eck  
Germany (Kreis Tuttlingen)

Tel. +49 7467-9474-0  
Fax +49 7467-9474-50  
info@asanus.de  
www.asanus.de